

# **Advanced Thermodynamics**

**(M2794.007900)**

**Min Soo Kim**

**Seoul National University**

# Introduction



Professor Min Soo Kim

Homepage : <http://reflab.snu.ac.kr>

E-mail : [minskim@snu.ac.kr](mailto:minskim@snu.ac.kr)

Tel) 880-8362

Assistant : Sung Bin Hong (301 – 218)

E-mail : [honutbin@snu.ac.kr](mailto:honutbin@snu.ac.kr)

Tel) 880-1648

# Introduction

## M2794.007900 Advanced Thermodynamics

Credits	Department			Representative Instructor			
				Name	Email		
3	Mechanical Engineering Major			Kim, Min Soo	minskim@snu.ac.kr		
1. Goals	<p>This course is aiming at extending fundamental knowledge on the laws of thermodynamics to various applications and at understanding statistical approach to diverse problems. Starting from the classical thermodynamics, basic principles and related topics will be dealt with. Statistical modeling of gas, solid, and liquid phases will be made, and behaviors of materials will be intensively studied.</p>						
2. Texts Book	Materials-Materials-Classical and Statistical Thermodynamics-Ashley H. Carter-Prentice-Hall-2001						
3. Evaluation	Attendance	Task	Midterm	Final	Attitude	Others	Total
	0%	10%	40%	40%	0%	10%	100%

# Introduction

4.Lecture Plan	[ 1 Week ]	Introduction
	[ 2 Week ]	Nature of Thermodynamics, Equation of State
	[ 3 Week ]	The First Law of Thermodynamics, Applications
	[ 4 Week ]	The Second Law of Thermodynamics, Applications
	[ 5 Week ]	Chemical Potential, Kinetic Theory of Gases
	[ 6 Week ]	Classical and Quantum Statistics
	[ 7 Week ]	Classical Statistical Treatment of Ideal Gas
	[ 8 Week ]	Mid-term Exam.
	[ 9 Week ]	Heat Capacity of Diatomic Gases
	[ 10 Week ]	Heat Capacity of Solid
	[ 11 Week ]	Bose-Einstein Gases (1)
	[ 12 Week ]	Bose-Einstein Gases (2)
	[ 13 Week ]	Fermi-Dirac Gases (1)
	[ 14 Week ]	Fermi-Dirac Gases (2)
	[ 15 Week ]	Final wrap-up

**Chapter 1**

**The Nature of Thermodynamics**

**Min Soo Kim**

**Seoul National University**

# 1.1 What is thermodynamics?

Thermodynamics?

Heat

motion

Effect of **temperature change**

**Transformations of energy**

- The study of **heat** in the field of physics.

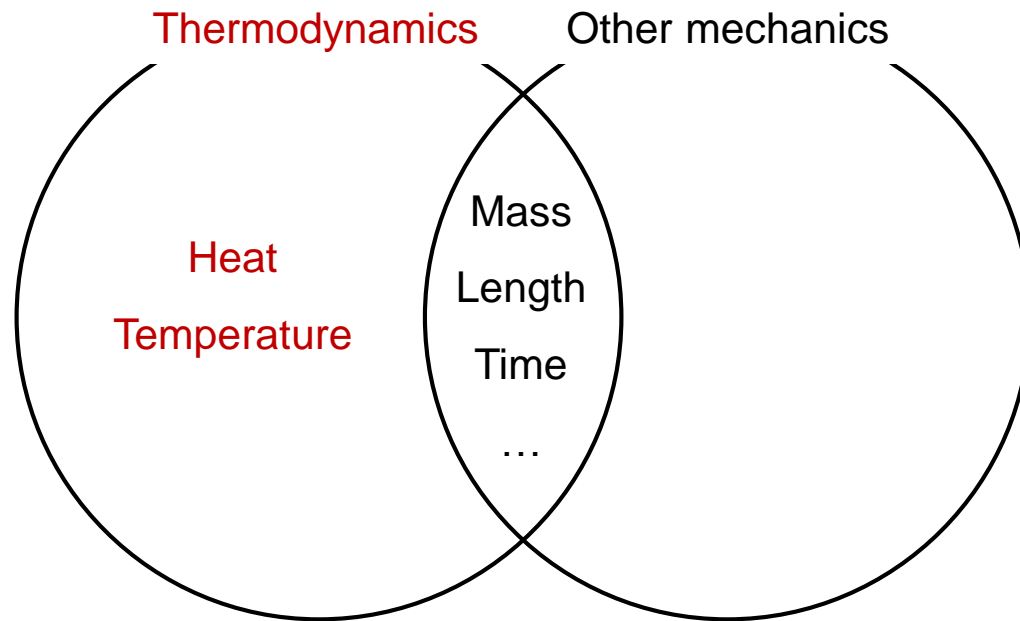

# 1.1 What is thermodynamics?

- The basis of thermodynamics is **experimental observation (empirical)**.
- **Zeroth, first, second and third laws of thermodynamics** were founded and formalized.

## Laws of thermodynamics

- The 0<sup>th</sup> law of thermodynamics: Thermal equilibrium (Temperature define)
- The 1<sup>st</sup> law of thermodynamics: Energy conservation
- The 2<sup>nd</sup> law of thermodynamics: Increase in entropy
- The 3<sup>rd</sup> law of thermodynamics: Absolute value of entropy

# 1.1 What is thermodynamics?

## Thermodynamics

- **Classical** thermodynamics

- **macroscopic**

: matter is **continuous** (direct observation, measurement).

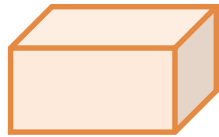

- **Statistical** thermodynamics

- **microscopic**

: matter is **particulate** (molecules and atoms).





# 1.1 What is thermodynamics?

## The scale of statistical thermodynamics

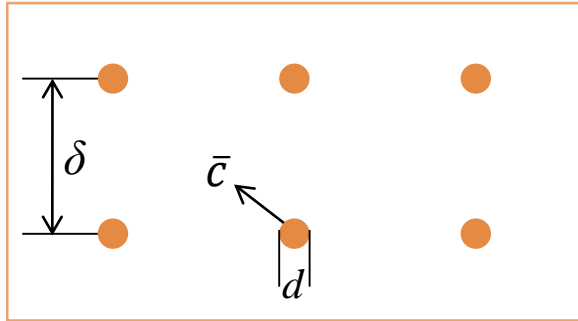

- Density of particles = 1mole / 22.4L =  $6 \times 10^{23}$  particles / 22.4L
- Mean velocity of particles  $\bar{c} \approx 450$  m/s
- Size of a particle  $d \rightarrow 1\text{Å} = 10^{-10}$  m = 0.1 nm scale
- Mean particle separation  $\delta \approx 10d = 10^{-9}$  m = 1 nm scale
- Mean free path  $\lambda \approx 10\delta = 100d = 10^{-8}$  m = 10 nm scale

## 1.2 Definitions

*System* – Some portion of the physical world, that could be a container of gas, a piece of metal, a magnet, etc.

*Surroundings* – The surrounding systems of the given system.  
The system can exchange energy or mass with them.

*Universe* – The system, together with its surroundings.

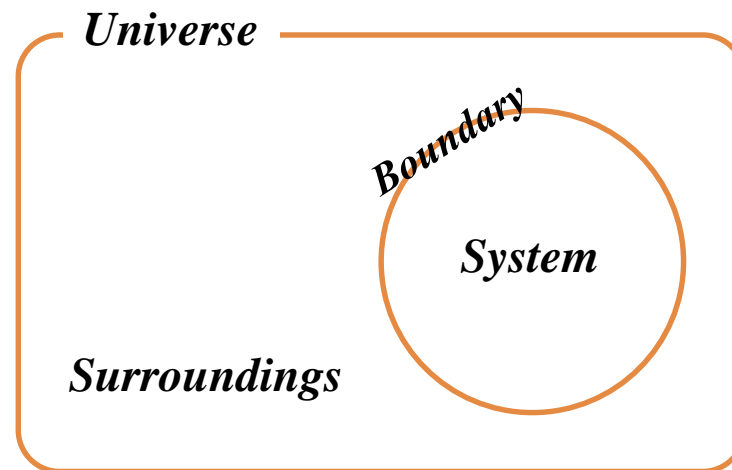

## 1.2 Definitions

*Boundary* – The boundary between a system and its surroundings through which changes may be imposed.

# 1.2 Definitions

## System ( $\neq$ control volume)

### *Open system*

- The system that **can exchange mass and energy** with its surrounding.

### *Closed system*

- The system that **cannot exchange mass, but can exchange energy** with its surrounding.

### *Isolated system*

- The system that **cannot exchange mass and energy** with its surrounding.

# 1.2 Definitions

## System

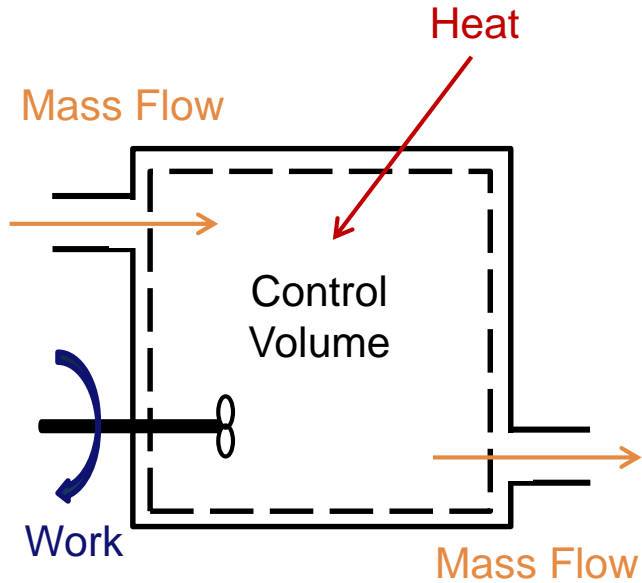

Open system

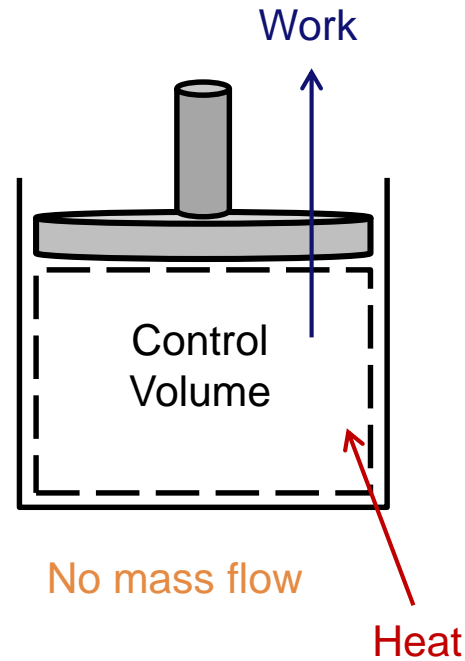

Closed system

No energy exchange

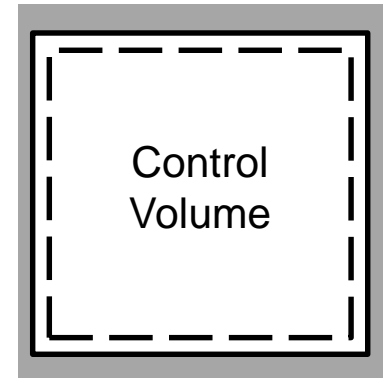

Isolated system

# 1.2 Definitions

## Boundary (= system wall)

### *Adiabatic wall*

- A boundary that permits **no heat interaction** with the surroundings.
- An isolated system is adiabatically contained, but a system with adiabatic wall is not always isolated.
- **Mechanical interactions**, such as material exchange, volume change, or magnetic field can be applied.

### *Diathermal wall*

- A boundary that freely **allows heat** to be exchanged.

# 1.2 Definitions

*Properties* – Observable characteristics of a system that describe the macroscopic behavior of a system.

## Property

### *Extensive property*

- Properties that are **proportional to the mass**.
- Volume, internal energy, entropy, etc.

### *Intensive property*

- Properties that are **independent to the mass**.
- Temperature, pressure, density, etc.

# 1.2 Definitions

## Property

- Usually, extensive properties (Volume ( $V$ ), enthalpy ( $H$ ), ...) are given by capital letter.
- Intensive properties Temperature ( $T$ ), and pressure ( $P$ ) are two exceptions to distinguish it from time ( $t$ ) and probability ( $p$ ).
- An extensive property can be converted to an intensive property by dividing by the mass. This is called a *specific value*.

$$\textit{Specific value} \equiv \frac{\text{Value of the extensive property}}{\text{mass of the system}}$$



## 1.2 Definitions

*1 kilomole* – unit of mass  $m$  in kilograms equal to the molecular weight.

ex) Molecular weight of oxygen gas ( $O_2$ ) = 32

*1 kilomole* of oxygen gas ( $O_2$ ) = 32 kg

*1 mole* of oxygen gas ( $O_2$ ) = 32 g

## 1.2 Definitions

*State* – A condition uniquely specified by a set of properties.

Two independent variables can specify the thermodynamic state of a single component system.

*Equilibrium state* – One in which the properties of the system are uniform throughout and do not change with time unless the system is acted upon by external influences.

*Non equilibrium state* – A state that characterizes a system in which gradient exist and whose properties vary with time.

*State variable* – Properties that describe equilibrium states.

## 1.2 Definitions

*Equation of state* – A functional relationship among the state variables for a system in equilibrium.

If the state variables are the pressure  $P$ , the volume  $V$ , and the temperature  $T$ , the equation of state (EOS) takes the form

$$f(P, V, T) = 0$$

This relationship reduces the number of independent variables of the system from three to two. The function  $f$  is assumed to be given as part of the specification of the system.

## 1.2 Definitions

The equation of state defines a surface in  $P$ - $V$ - $T$  space.

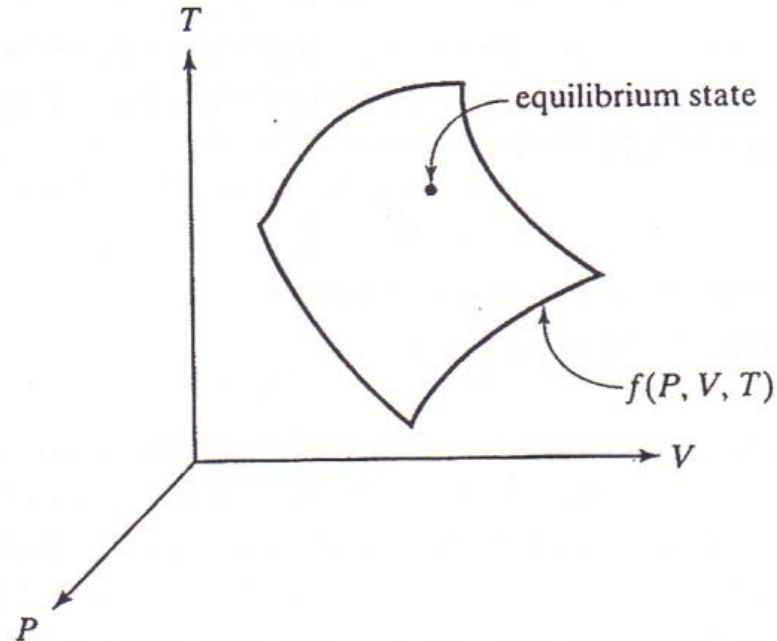

Any point lying on this surface represents a state in equilibrium.

## 1.2 Definitions

*Path* – A series of states through which a system passes.

*Process* – A change of the state of a system.

‘change of state’  $\neq$  change of phase or phase transformation

*Cyclical process* – A process of which the initial and final states are the same.

# 1.2 Definitions

## Process

### *Quasi-static process*

- At each instant, the system **departs only infinitesimally** from an equilibrium state.

### *Reversible process*

- A quasi-static process **without any dissipative forces**.

Reversible process  $\neq$  Quasi-static process

### *Irreversible process*

- A process includes **a finite change** with dissipation

## 1.2 Definitions

In many processes, some property of the system remains constant.

*Isobaric process* – The **pressure** of the system remains constant during process.

*Isochoric process* – The **volume** of the system remains constant during process.

*Isothermal process* – The **temperature** of the system remains constant during process.

## 1.2 Definitions

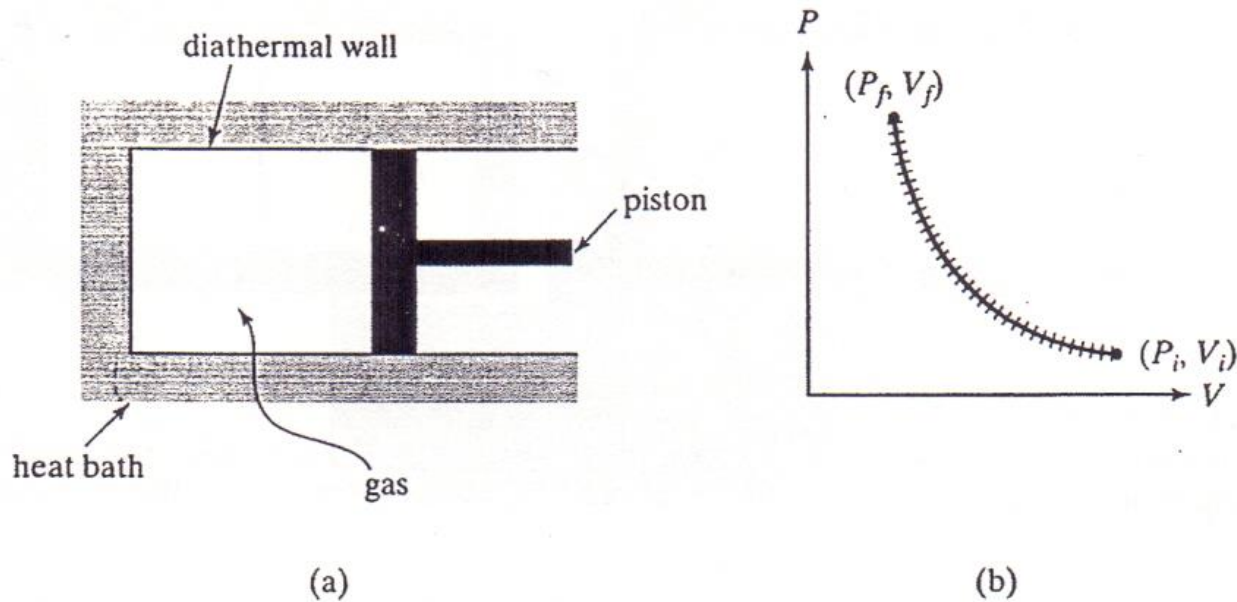

In case of figure 1.3, a piston enclosing a gas is immersed in a heat bath, so that the gas is kept at constant temperature.

If the gas is very **slowly compressed**, the process is **quasi-static, reversible, and isothermal**.



## 1.2 Definitions

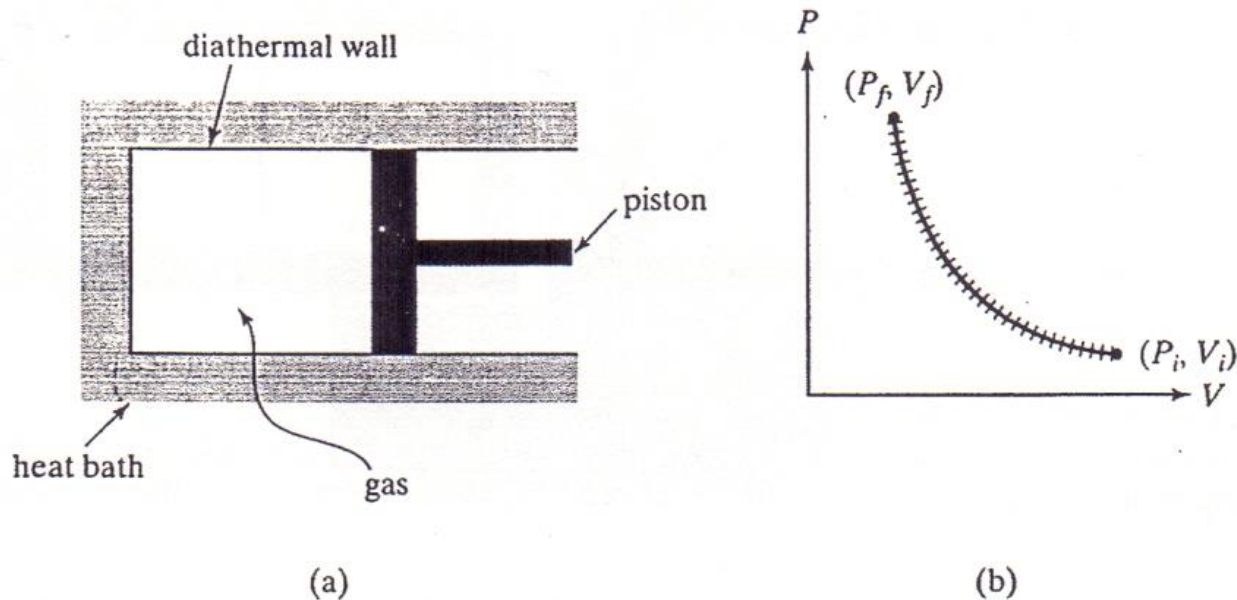

Instead of a gradual compression, if the piston is given a **violent push**, sound or shock and turbulence will be generated, accompanied by strong temperature and pressure gradients. In this case, **the process is an irreversible, non-equilibrium process** that cannot be represented by a path in the  $P$ - $V$  plane. Only the end points can be plotted

## 1.4 Limits of the continuum

- We tacitly assume that classical thermodynamics is a continuum theory, that properties vary smoothly from point to point in the system.

But if all system are made up of atoms and molecules, it is reasonable to ask:

**how small a volume** can we be concerned with and still have confidence that **continuum theory is valid?**

we can roughly obtain an approximate answer to this question by invoking Avogadro's law:

at standard temperature and pressure, **one kilomole of gas occupies  $22.4 \text{ m}^3$**

*1 kilomole =  $N_A = 6.02 \times 10^{26}$  molecules*

# 1.4 Limits of the continuum

- Density of particles =  $1 \text{ mole} / 22.4 \text{ L} = 6 \times 10^{23} \text{ particles} / 22.4 \text{ L}$

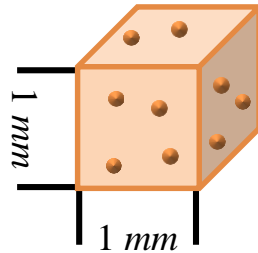

# of particles in  $1 \text{ mm}^3 \approx 10^{16}$

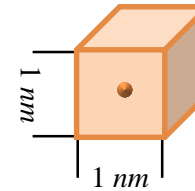

# of particles in  $1 \text{ nm}^3 \approx 0.01$

- Classical thermodynamics is applicable down to very small macroscopic volumes, but **ultimately a limit is reached where the theory will break down.**

# 1.4\* Heat carriers

## Heat carriers

- Heat transfer involves the motion of **heat carriers** generated by temperature difference.

*Gas molecule* – A heat carrier is gas.

*Electron* – A heat carrier in metals.

*Phonon* – A heat carrier in solids (electrical insulators).

# 1.4\* Heat carriers

## Phonon

The interatomic interactions in crystals can be represented by a mass-spring system.

If one side of the solid is hotter, the atoms near the hot side will have larger vibrational amplitudes, which will be felt by the atoms on the other side of the system through the propagation and interaction of lattice wave.

A quantized lattice wave is called a *phonon*.

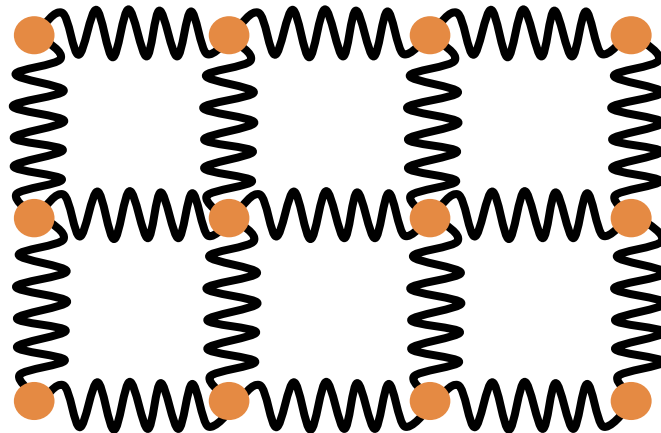

# 1.7 Temperature and the zeroth law of thermodynamics

## The zeroth law

*: If two systems are separately in thermal equilibrium with a third system, they are in equilibrium with each other.*

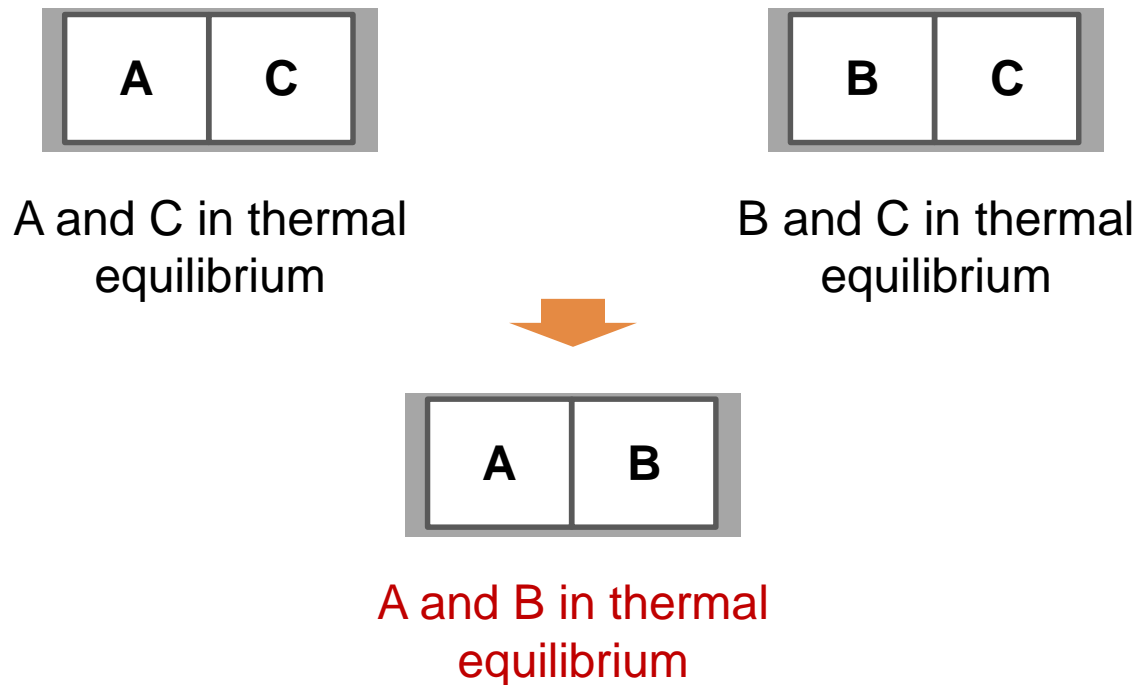

# 1.7 Temperature and the zeroth law of thermodynamics

## Temperature

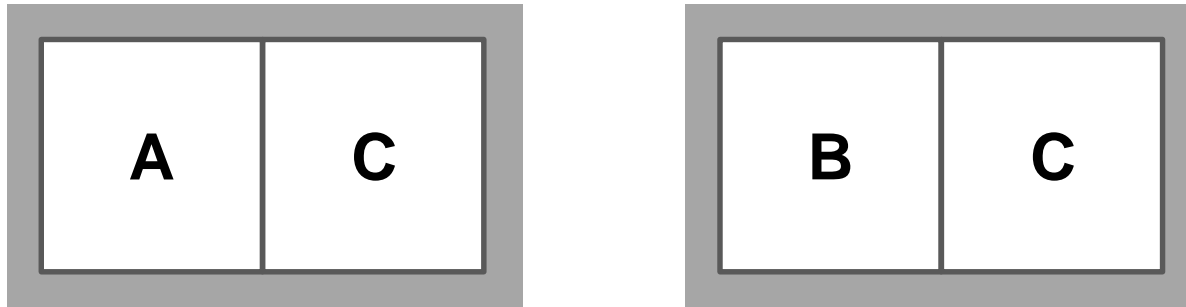

Figure 1.3

The system C can be thought of as a thermometer. Its state is given by the pair of variables  $(P_C, V_C)$ . From observations, if we choose a particular value for  $P_A$ , then  $V_a$  will be uniquely determined (only one variable is independent).

# 1.7 Temperature and the zeroth law of thermodynamics

The conditions under which A and C are in equilibrium may be expressed by the equation

$$F_1(P_A, V_A, P_C, V_C) = 0, \quad (1)$$

Where  $F_1$  is some function of the four variables.

We assume that this equation can be solved for  $P_C$

$$P_C = f_1(P_A, V_A, V_C). \quad (2)$$



# 1.7 Temperature and the zeroth law of thermodynamics

Next we place system B and C in thermal contact (Figure 1.x(b)).

For equilibrium,

$$F_2(P_B, V_B, P_C, V_C) = 0 \quad (3)$$

or

$$P_C = f_2(P_B, V_B, V_C). \quad (4)$$

Equating equations (2) and (4), we obtain the condition under which A and B are separately in equilibrium with C

$$f_1(P_A, V_A, V_C) = f_2(P_B, V_B, V_C). \quad (5)$$

## 1.7 Temperature and the zeroth law of thermodynamics

But, according to the zeroth law, A and B are then in equilibrium with each other, so that

$$F_3(P_A, V_A, P_B, V_B) = 0. \quad (6)$$

Solving for  $P_A$ , we obtain

$$P_A = f_3(V_A, P_B, V_B). \quad (7)$$

Now, equation (5) can also be solved for  $P_A$ , in principle

$$P_A = g(V_A, P_B, V_B, V_C). \quad (8)$$

# 1.7 Temperature and the zeroth law of thermodynamics

Equation (8) states that  $P_A$  is determined by four variables, whereas equation (7) says that it is a function of only three.

This can only mean that the function  $f_1$  and  $f_2$  in equation 5 contain  $V_C$  in such a form that it cancels out on the two sides of the equation.

For example,

$$f_1 = \phi_1(P_A, V_A) \zeta(V_C) + \eta(V_C),$$

$$f_2 = \phi_2(P_B, V_B) \zeta(V_C) + \eta(V_C).$$

When the cancellation is performed, we have

$$\phi_1(P_A, V_A) = \phi_2(P_B, V_B). \quad (9)$$

# 1.7 Temperature and the zeroth law of thermodynamics

Extending the argument to additional systems, we get

$$\phi_1 (P_A, V_A) = \phi_2 (P_B, V_B) = \phi_3 (P_C, V_C) = \dots . \quad (10)$$

For any system in thermal equilibrium with a given system, we can choose to write

$$\phi_1 (P_A, V_A) = T, \quad (11)$$

Where we define  $T$  as the empirical *temperature* and equation 11 is the equation of state (EOS) of the system.

Equation 10 then says that systems in thermal equilibrium with one another have the same temperature. Thus temperature is a property of a system that determines if thermal equilibrium exists some other system.

# 1.7\* The laws of thermodynamics

## The first law

Law of conservation of energy.

$$\frac{Q_{12}}{\text{Transferred heat}} - \frac{W_{12}}{\text{Work}} = \frac{E_2 - E_1}{\text{Internal energy (temperature related)}}$$

# 1.7\* The laws of thermodynamics

## The first law

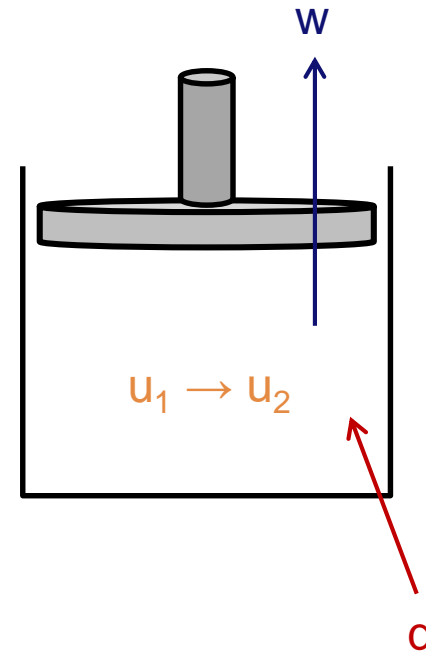
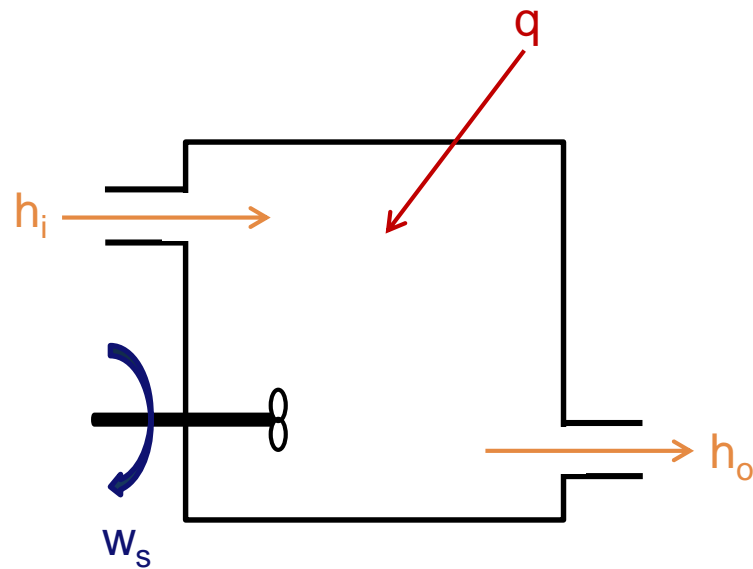

# 1.7\* The laws of thermodynamics

## The second law

For isothermal, quasi-static, irreversible process,

$$ds \geq \frac{\delta Q}{T}, \quad \text{or} \quad ds = \frac{\delta Q}{T} + \delta\theta, \quad \delta\theta \geq 0$$

entropy generation  
(disorder production)

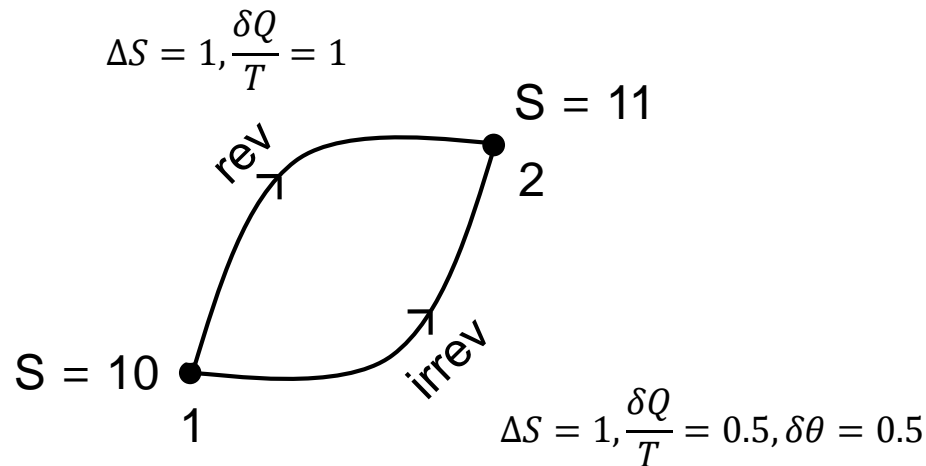

# 1.7\* The laws of thermodynamics

## The second law

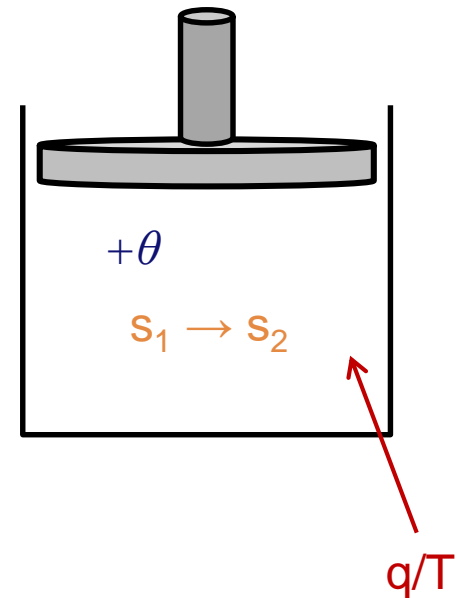
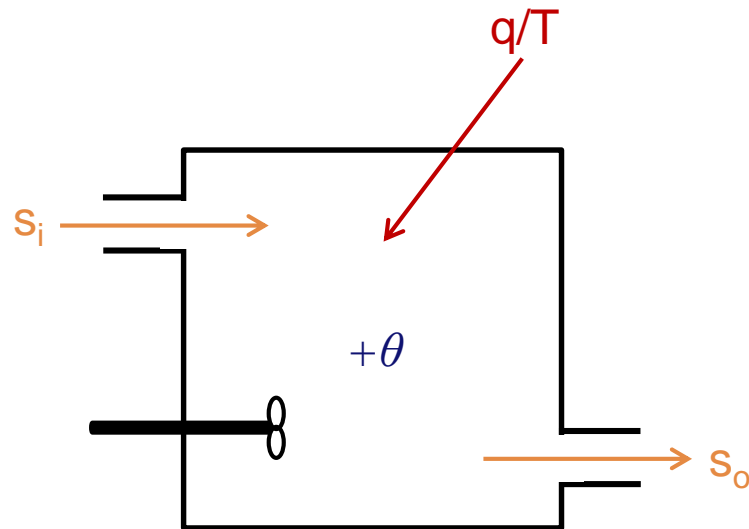



# 1.7\* The laws of thermodynamics

## The third law

Behavior of  $S$  as  $T \rightarrow 0$

$$\lim_{T \rightarrow 0} \Delta S = 0$$

It is possible to assign  $S(T=0) = 0$

This normalized entropy is called 'absolute entropy'

$$\lim_{T \rightarrow 0} S = 0$$