

# Electro-Optics

## Theory of Lasers (3)

Yoonchan Jeong

School of Electrical Engineering, Seoul National University

Tel: +82 (0)2 880 1623, Fax: +82 (0)2 873 9953

Email: [yunchan@snu.ac.kr](mailto:yunchan@snu.ac.kr)

# Multimode Laser Oscillation

Laser oscillation condition:

$$\gamma_{th}(\nu) = \alpha - \frac{1}{l} \ln r_1 r_2 \rightarrow \gamma(\nu) = (N_2 - N_1) \frac{c^2}{8\pi n^2 \nu^2 \tau_{sp}} g(\nu)$$

$$\nu_{q+1} - \nu_q = \frac{c}{2nl}$$

Homogeneous atomic system:

Inhomogeneous atomic system:

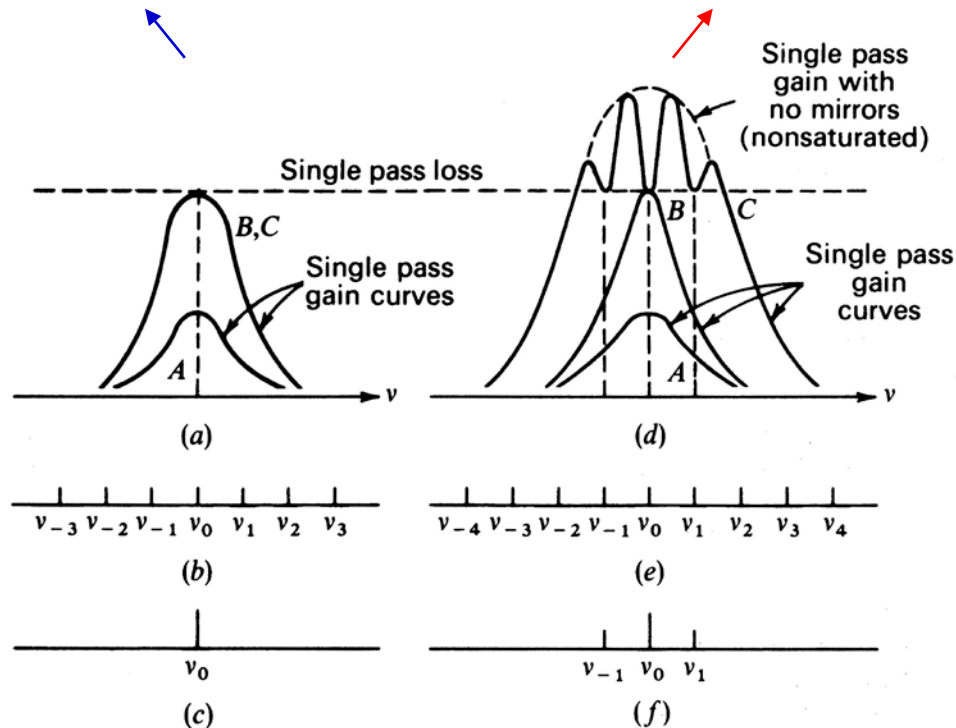

# Mode Locking (1)

Mode separation in an **inhomogeneously** broadened system:

$$\omega_{q+1} - \omega_q = \frac{\pi c}{l} \equiv \omega \quad \leftarrow n = 1$$

Total electric field:

$$e(t) = \sum_n E_n e^{i[(\omega_0 + n\omega)t + \phi_n]} \quad \leftarrow \omega_0 = m\pi c / l, \quad T = 2\pi / \omega = 2l / c$$

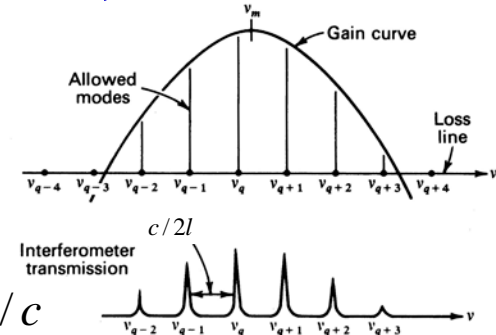

A. Yariv, *Quantum Electronics*, 3rd ed., Wiley, 1989.

In case  $E_n$  and  $\phi_n$  are fixed (locked):

$$\begin{aligned} e(t+T) &= \sum_n E_n \exp\left\{i\left[(\omega_0 + n\omega)\left(t + \frac{2\pi}{\omega}\right) + \phi_n\right]\right\} \\ &= \sum_n E_n \exp\{i[(\omega_0 + n\omega)t + \phi_n]\} \exp\left\{i\left[2\pi\left(\frac{\omega_0}{\omega} + n\right)\right]\right\} = e(t) \end{aligned}$$

**“Periodic”**

Taking  $E_n = 1$  and  $\phi_n = 0$ :

$$\begin{aligned} e(t) &= \sum_{-(M-1)/2}^{(M-1)/2} \exp[i(\omega_0 + n\omega)t] \\ &= \exp(i\omega_0 t) \frac{\sin(M\omega t / 2)}{\sin(\omega t / 2)} \end{aligned}$$

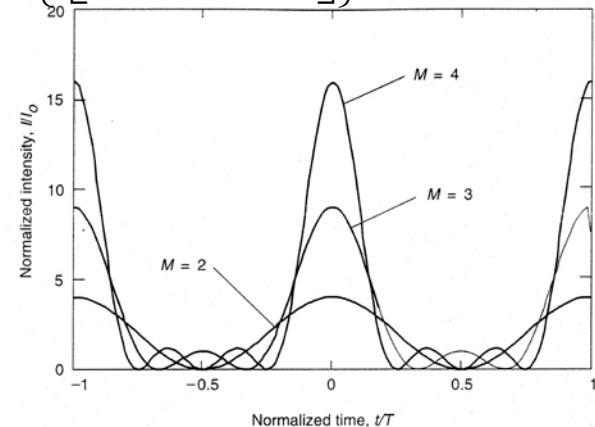

A. Yariv, *Quantum Electronics*, 3rd ed., Wiley, 1989.

# Mode-Locked Lasers (1)

Methods of mode locking: Loss (gain) modulation

Active mode locking: EOM, AOM, etc.

Passive mode locking: Saturable absorber, e.g. dye, SESAM, etc.

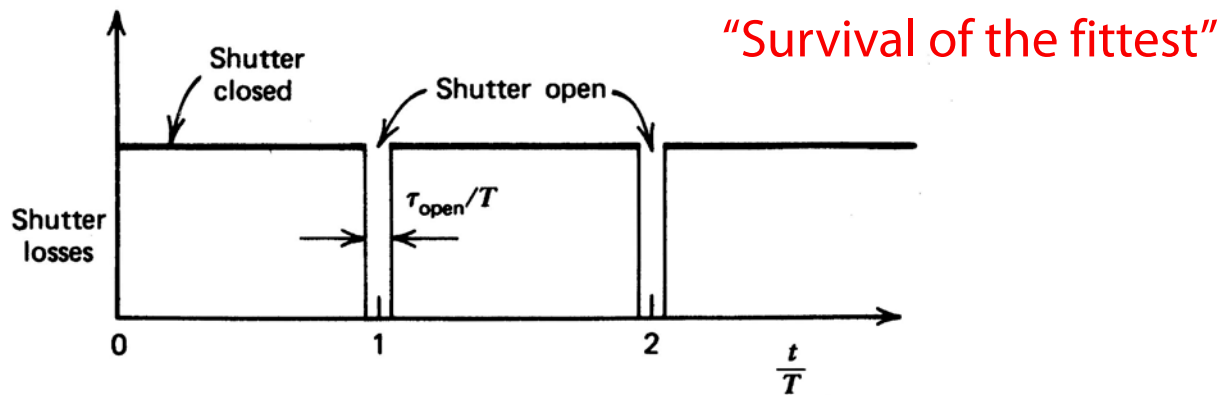

A. Yariv, *Quantum Electronics*, 3rd ed., Wiley, 1989.

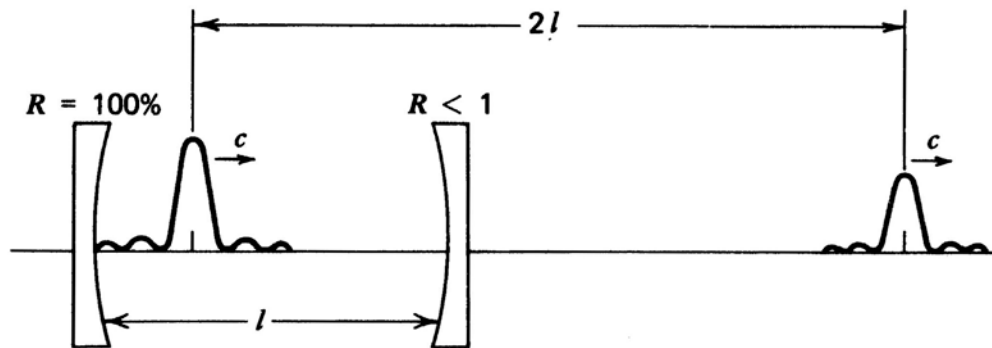

A. Yariv, *Quantum Electronics*, 3rd ed., Wiley, 1989.

# Mode-Locked Lasers (2)

Model-locked fibre laser based on SESAM: 310 fs, 24.3 MHz

Experimental arrangement:

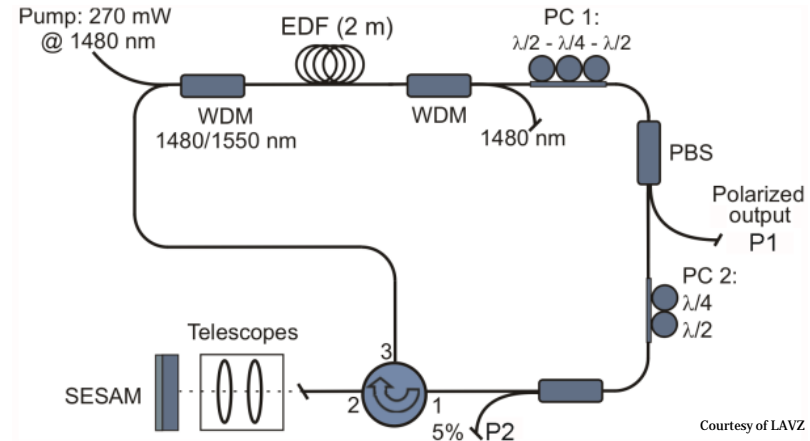

Pulse shape and spectrum:

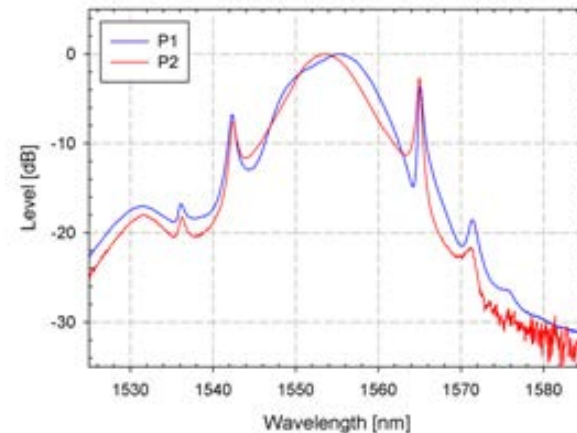
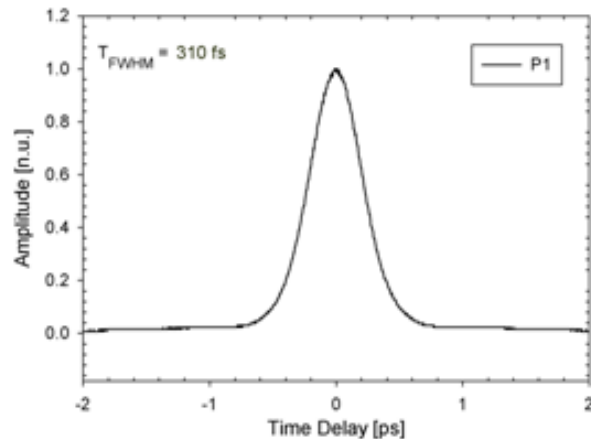

# Q Switching (1)

Initially lasing is prohibited:  $Q \ll 1$

Total number of photons in the cavity when  $Q$  is restored:

$$\frac{d\phi}{dt} = \phi \left( \underbrace{\frac{\gamma c L}{n l}}_{\text{Gain}} - \underbrace{\frac{1}{t_c}}_{\text{Loss (Cavity decay time)}} \right) \rightarrow \tau = \frac{t}{t_c}$$

$$\rightarrow \frac{d\phi}{d\tau} = \phi \left( \frac{\gamma}{n l / c L t_c} - 1 \right) = \phi \left( \frac{\gamma}{\gamma_{th}} - 1 \right) \rightarrow \gamma \propto \eta$$

$\leftarrow \eta \equiv (N_2 - N_1)V$

$$= \phi \left( \frac{\eta}{\eta_{th}} - 1 \right)$$

Number of photons generated by induced emission

$$\rightarrow \frac{d\eta}{d\tau} = -2\phi \frac{\eta}{\eta_{th}}$$

$$\rightarrow \frac{d\phi}{d\eta} = \frac{\eta_{th}}{2\eta} - \frac{1}{2} \rightarrow \phi - \phi_i = \frac{1}{2} \left[ \eta_{th} \ln \frac{\eta}{\eta_i} - (\eta - \eta_i) \right]$$

$$\rightarrow \phi \cong \frac{1}{2} \left[ \eta_{th} \ln \frac{\eta}{\eta_i} - (\eta - \eta_i) \right]$$

# Q Switching (2)

Final inversion:  $t \gg t_c$

$$\phi \cong \frac{1}{2} \left[ \eta_{th} \ln \frac{\eta}{\eta_i} - (\eta - \eta_i) \right] \rightarrow 0$$

$$\rightarrow \frac{\eta_f}{\eta_i} = \exp\left(\frac{\eta_f - \eta_i}{\eta_{th}}\right) \rightarrow \text{To be solved graphically or numerically}$$

Instantaneous power output:

$$P = \phi h \nu / t_c$$

$$= \frac{h \nu}{2 t_c} \left[ \eta_{th} \ln \frac{\eta}{\eta_i} - (\eta - \eta_i) \right]$$

Peak power output:

$$\rightarrow \partial P / \partial \eta = 0 \rightarrow \eta = \eta_{th}$$

$$\rightarrow P_{peak} = \frac{h \nu}{2 t_c} \left[ \eta_{th} \ln \frac{\eta_{th}}{\eta_i} - (\eta_{th} - \eta_i) \right]$$

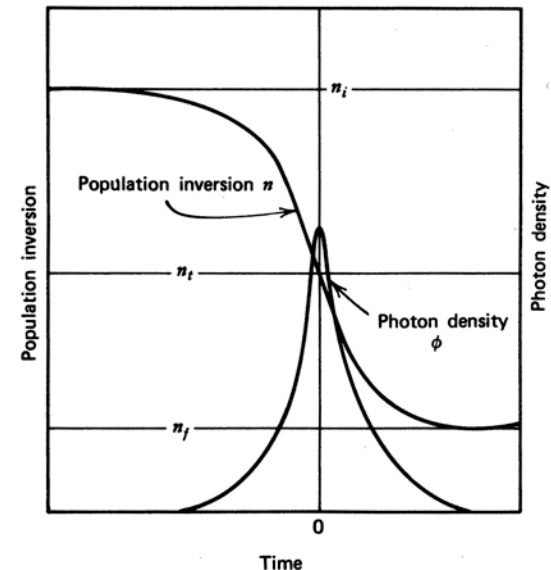

A. Yariv, *Quantum Electronics*, 3rd ed., Wiley, 1989.

# Q-Switched (Giant Pulse) Lasers (1)

Methods of Q switching:

Active Q switching → Mechanical Q-SW, EOM, AOM, etc.

Passive Q switching → Saturable absorber, e.g. dye, SESAM, etc.

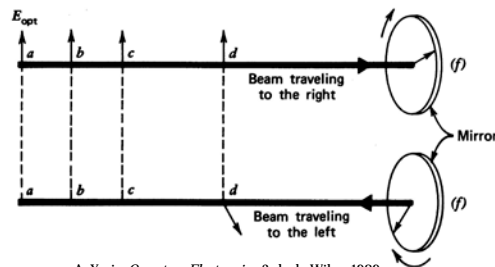
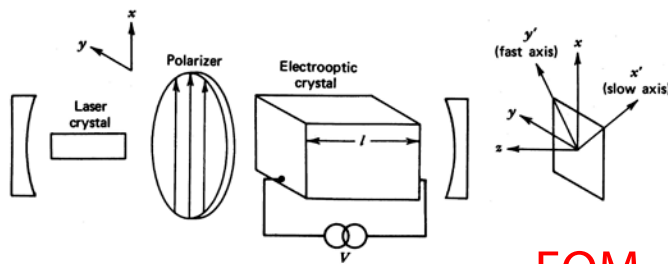
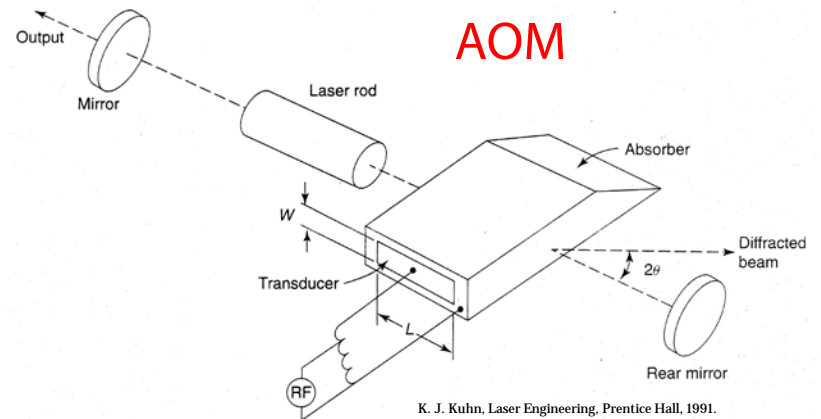
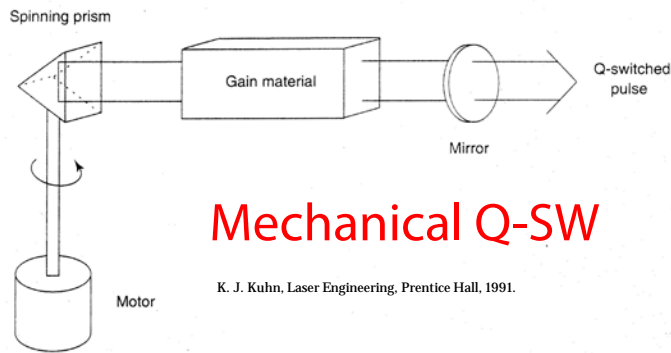

A. Yariv, Quantum Electronics, 3rd ed., Wiley, 1989.

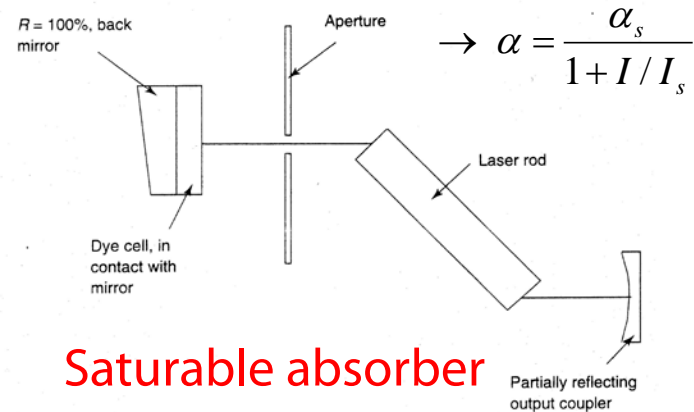



# Q-Switched (Giant Pulse) Lasers (2)

120-W Q-switched cladding-pumped Yb-doped fibre laser:

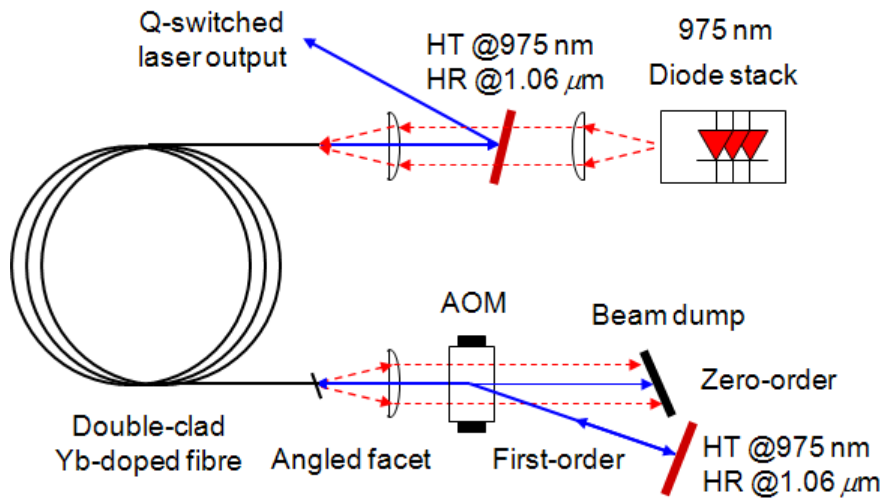

Pulse energy & ave. power:

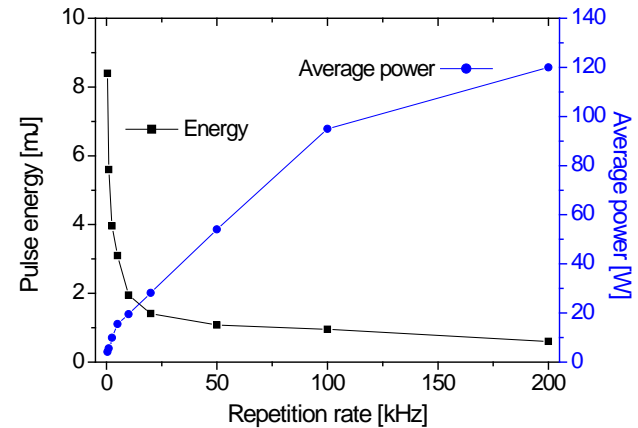

Pulse shape and spectrum:

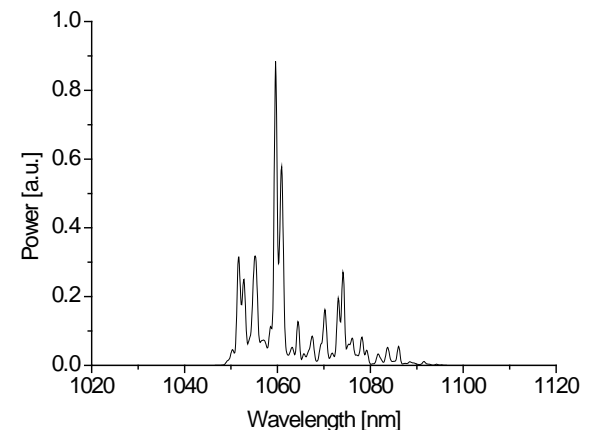
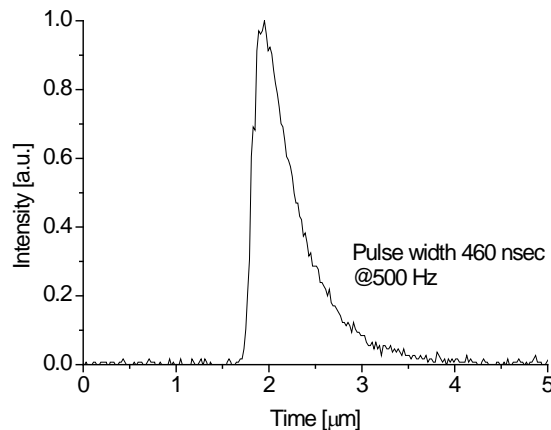

# Relaxation Oscillation & ASE Build-Up

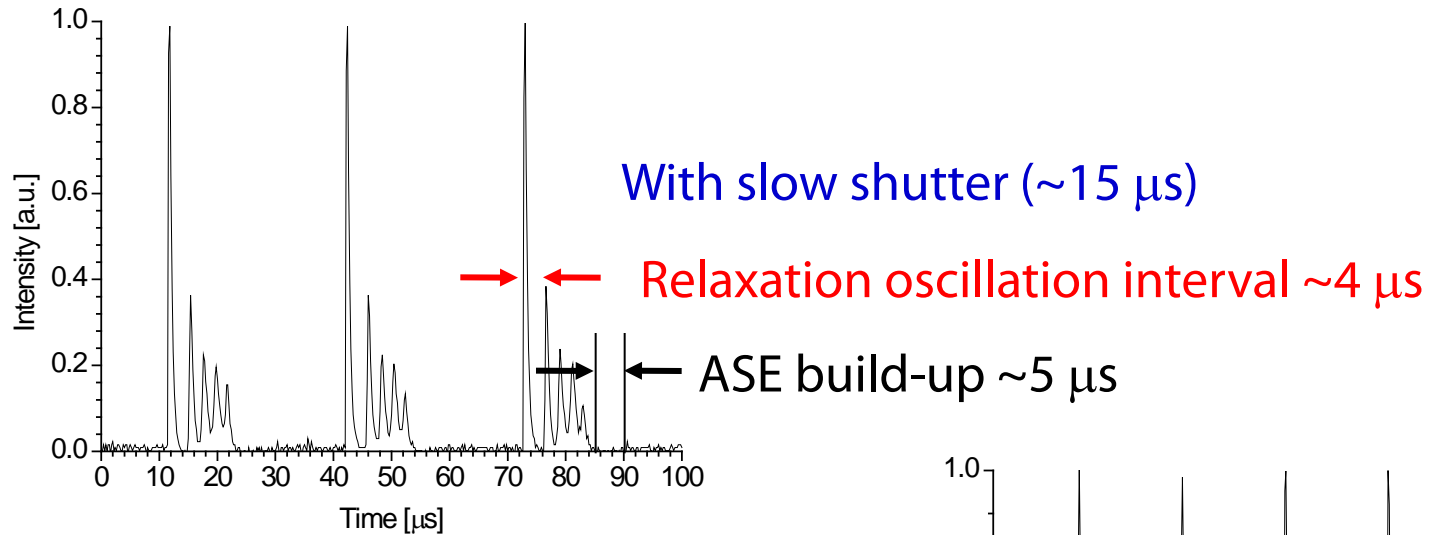

Suppression of oscillations  
between pulses:  
Fast shutter ( $< 0.5 \mu\text{s}$ ), high repetition rate

