

# 해양플랜트 공학 입문

서유택

# Subsea Design Phases

## 1. Concept Selection/Feasibility

- Compare various flowline routes
- Pipe size and insulation requirements
- Topsides requirements

## 2. FEED

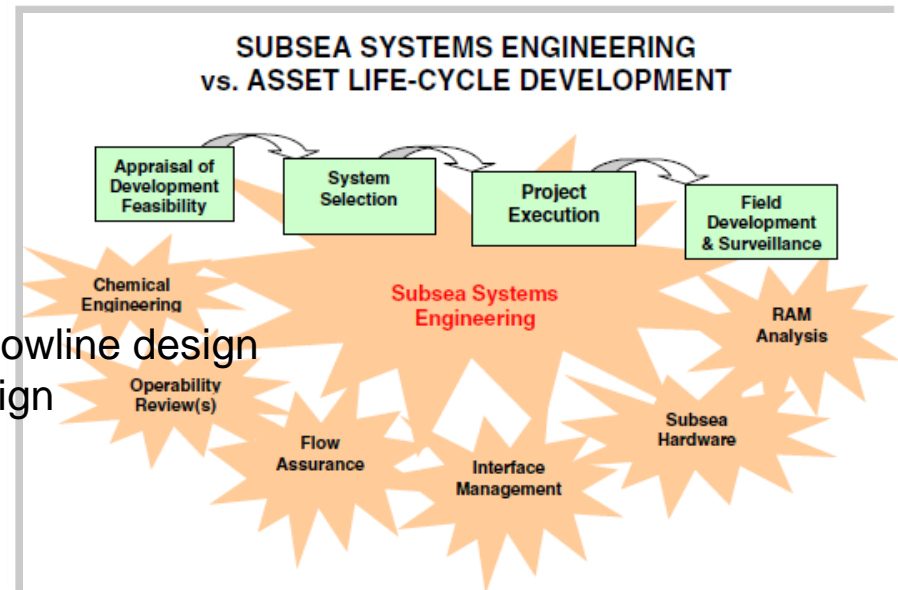
- Determine most viable flowline route & flowline design
- Chemicals requirements & umbilical design
- Operability & topsides requirements

## 3. Detailed Design

- Flowline design meets life time functional requirements
- Chemicals requirements & umbilical design
- Operability and topsides design for production & export

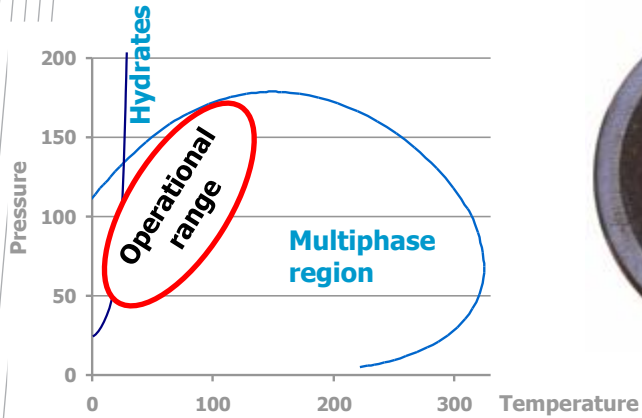
## 4. Operations

- Operator training
- Adjust operating procedures according to reality

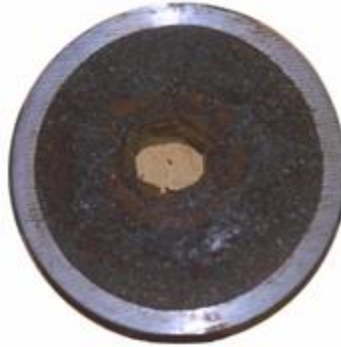


# Fluid Related Issues

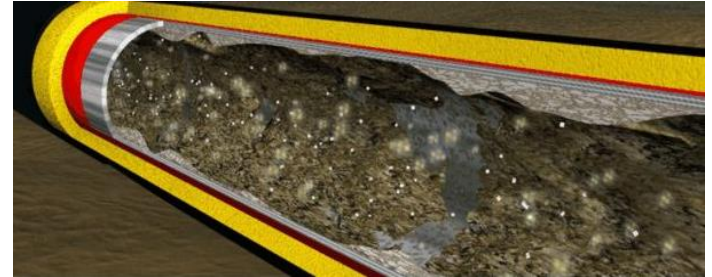
## Multiphase composition



## Wax / Asphaltenes



## Emulsion / Foam



## Sand / Erosion



## Gas Hydrates



## Corrosion



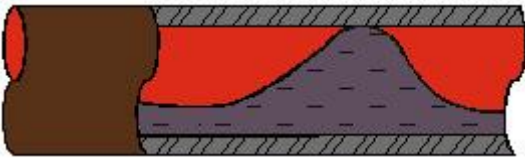
## Scale (salts)



# Design Related Issues

## Pipeline sizing

pressure loss vs slugging



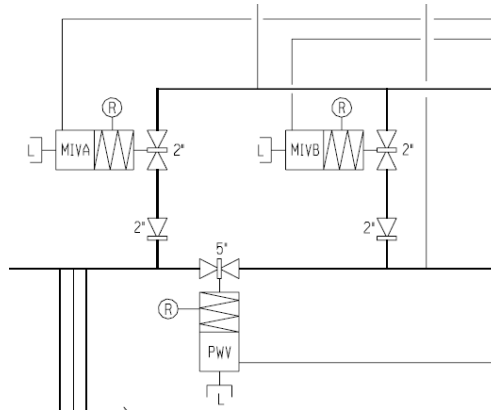
## Choke design

to minimize pressure loss and erosion



## Design of Chemical Injection Systems

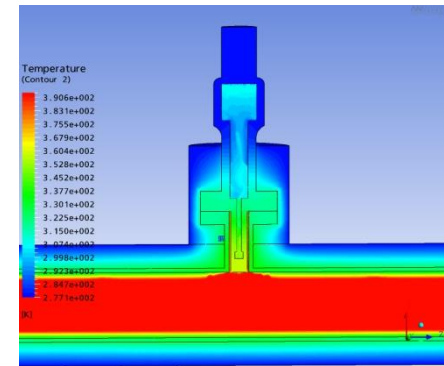
to minimize risk of hydrates, scale, corrosion etc.



Flow assurance is to take precautions to **Ensure Deliverability and Operability**

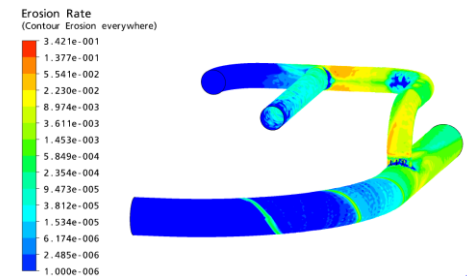
## Thermal Insulation Design

to keep fluids warm and minimize risk of hydrates and wax



## Erosion analysis

Erosion wear in complex geometries



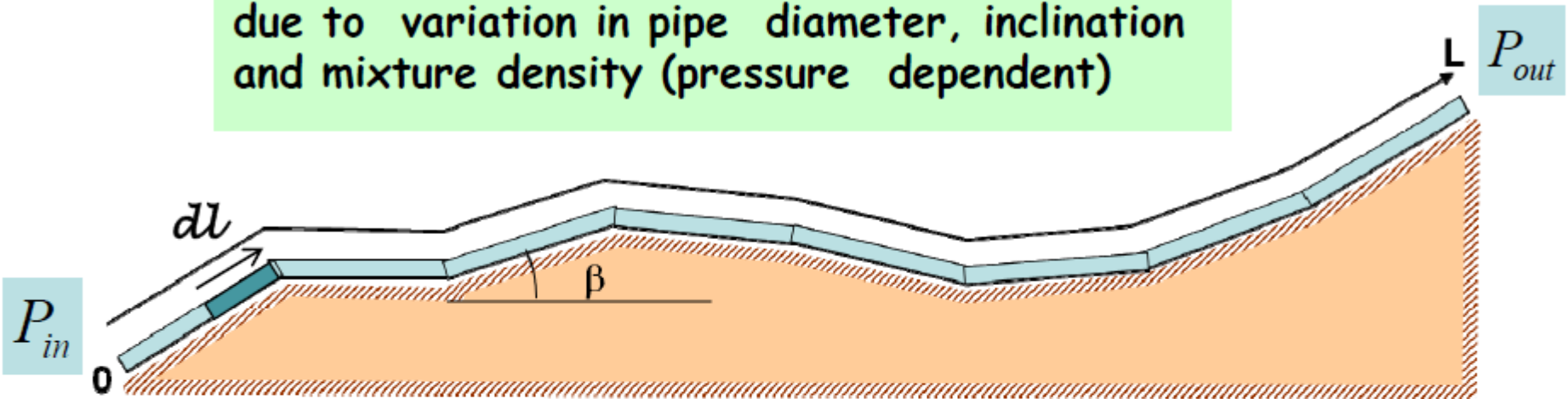
# Flow Assurance

## : Interface with Reservoir Evaluation and Topsides Design

- Production profiles; FWHP, FWHT, WI rates
- Reservoir depth, temperature, and pressure
- Required topside arrival pressure (separator pressure + ~50 psi) and temperature
- Separator and slug catcher capacities
- Capacities and pressure ratings of
  - : Export pumps and compressors
  - : Gas lift compressors
  - : Chemicals pumps
  - : Hydraulic fluid pumps
- Topside piping/equipment – temperature ratings
- Topside storage capacities for oil, diesel, chemicals and water

# Pressure drop calculation for long pipeline

The pressure gradient varies along the pipe due to variation in pipe diameter, inclination and mixture density (pressure dependent)



Pressure at exit:  $P_{out} = P_{in} + \Delta P$



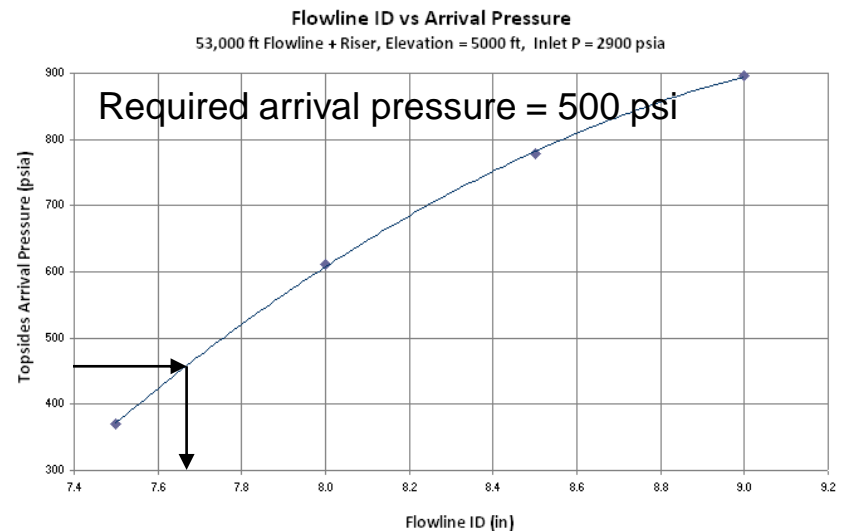
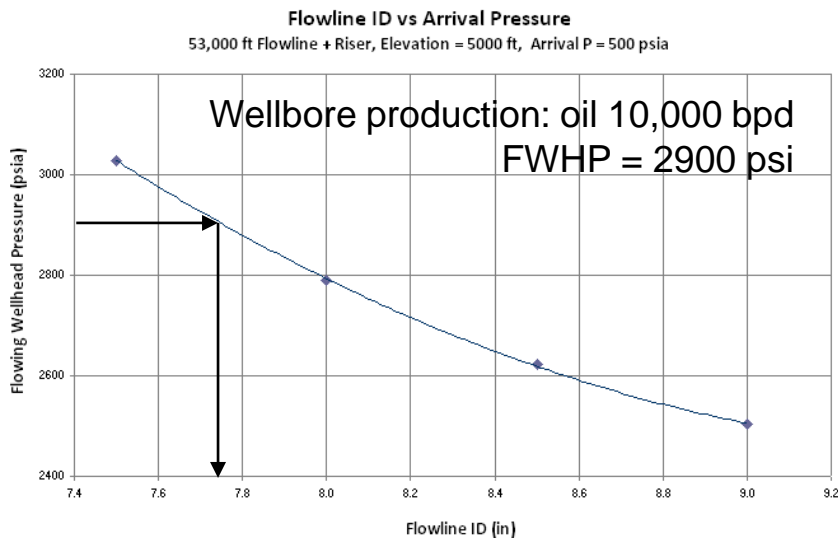
*Sum of pressure drop in all pipe segment*

**Challenge in multiphase flow:**

- *The pressure profile depends on the pressure!*
- *Requires iterative numerical solver*

# Determine Line Size

- Most offshore pipelines are sized by use of three design criteria : Available pressure drop, allowable velocities, and slugging
- Line sizes calculated by use of the steady state simulators
- The maximum allowable pressure drop is constrained by its required outlet pressure and available inlet pressure



# Slugging

- Slugging

- : Periods of low flow followed by periods of high flow (liquid bomb)

- : Occurs in multiphase flowlines at low gas velocities

- : Causes

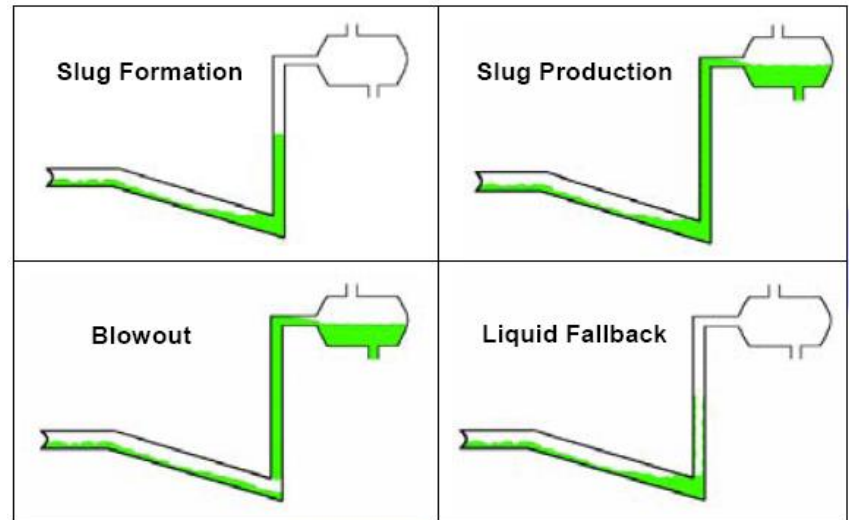
- Low fluid velocity
    - Seabed bathymetry
    - Riser type

- Control strategy

- : Increase flowrate  
(playing with topside valve)

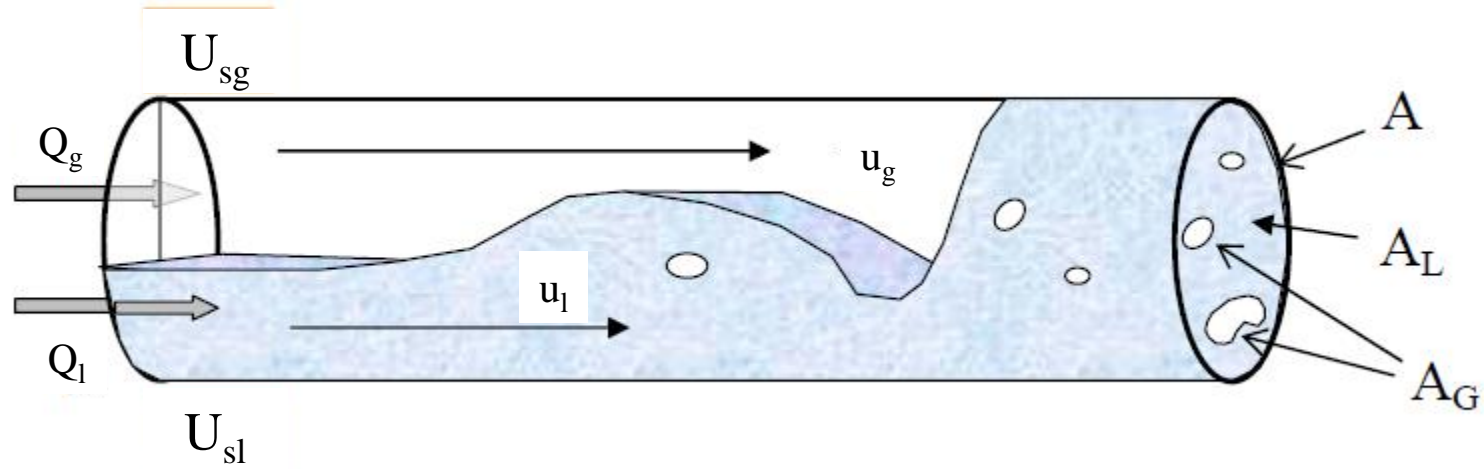
- : Slug catcher

- : Gas lift / Gas recirculation





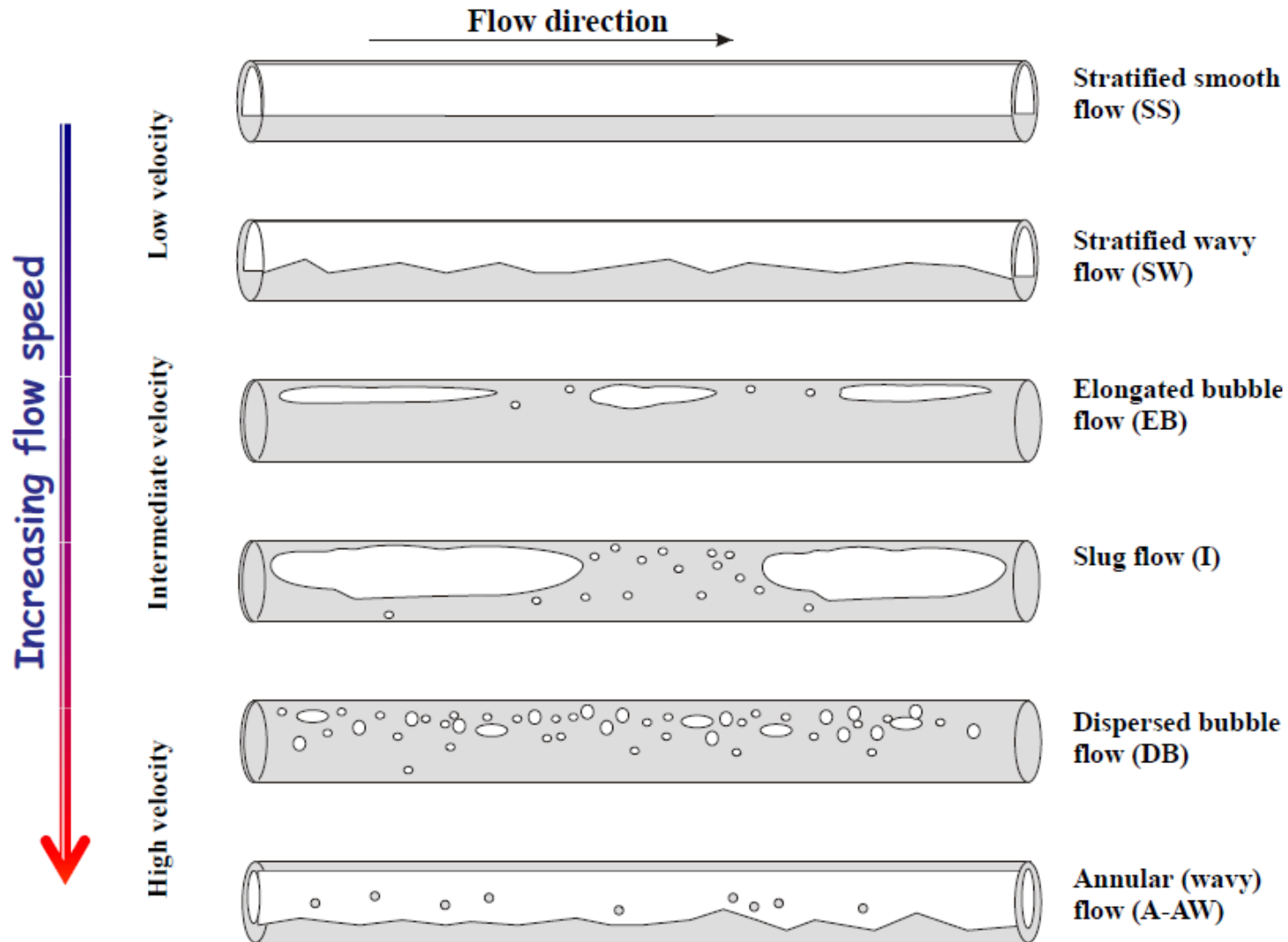
# Basic quantities and definitions



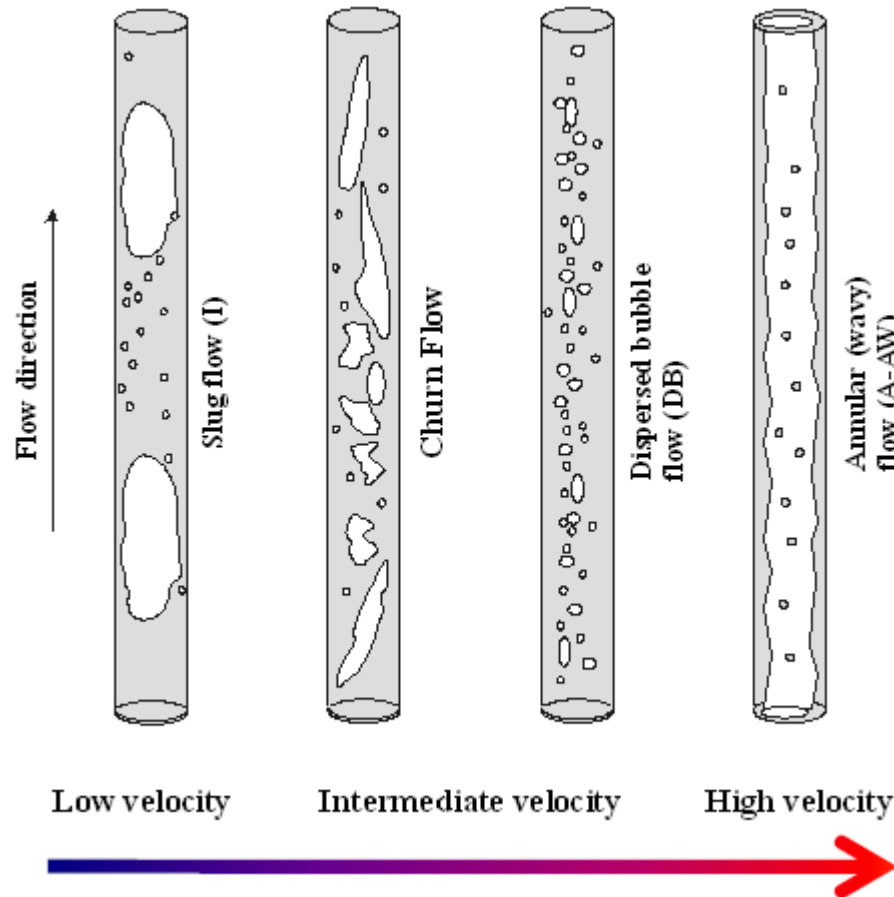
- Superficial velocity
- Mixture velocity
- Liquid holdup
- Gas void fraction
- Average gas and liquid velocities
- Slip velocity
- Water cut
- Mixture density
- Mixture viscosity

# Gas liquid flow regimes

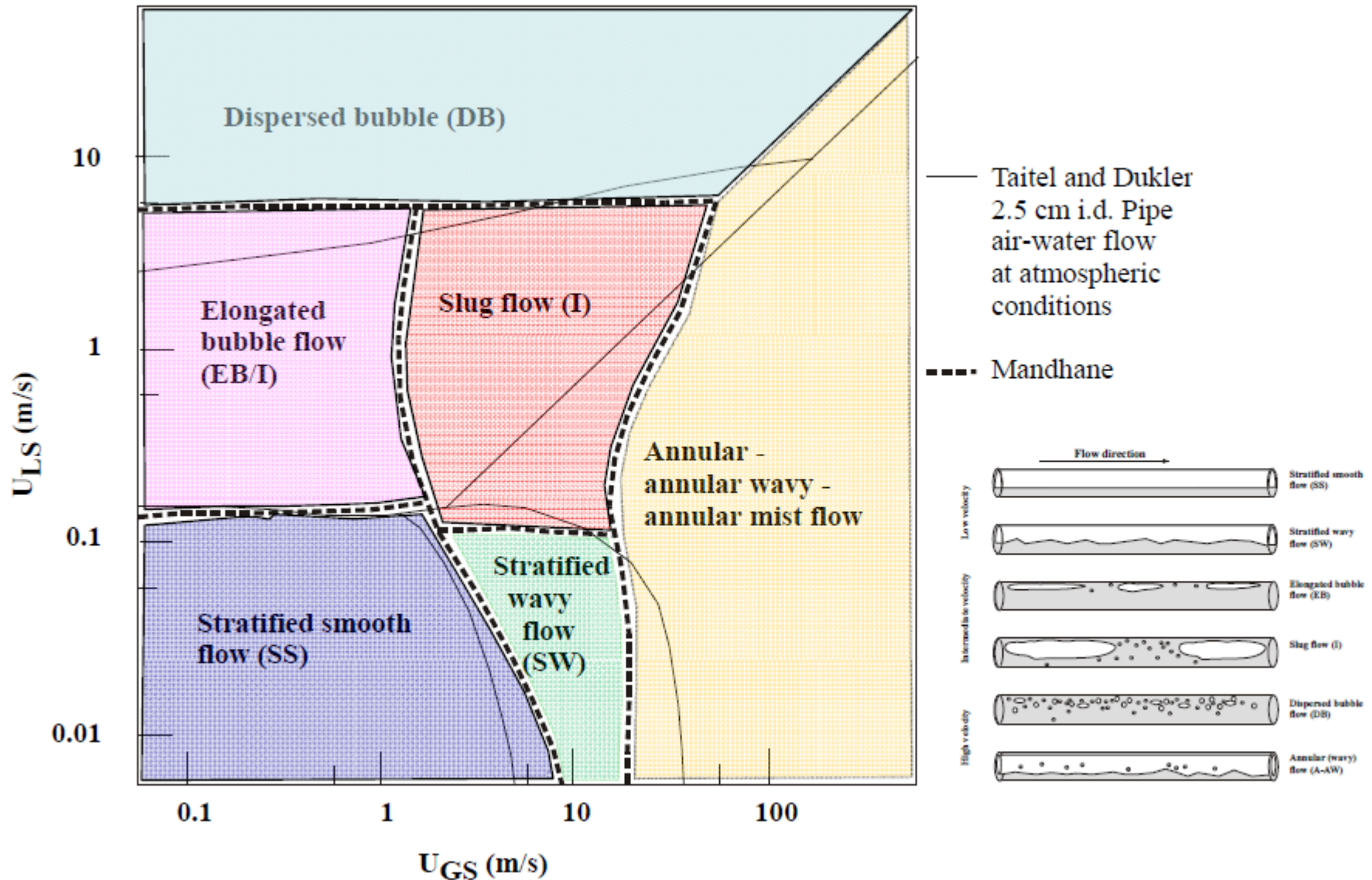
- In horizontal and near horizontal pipelines



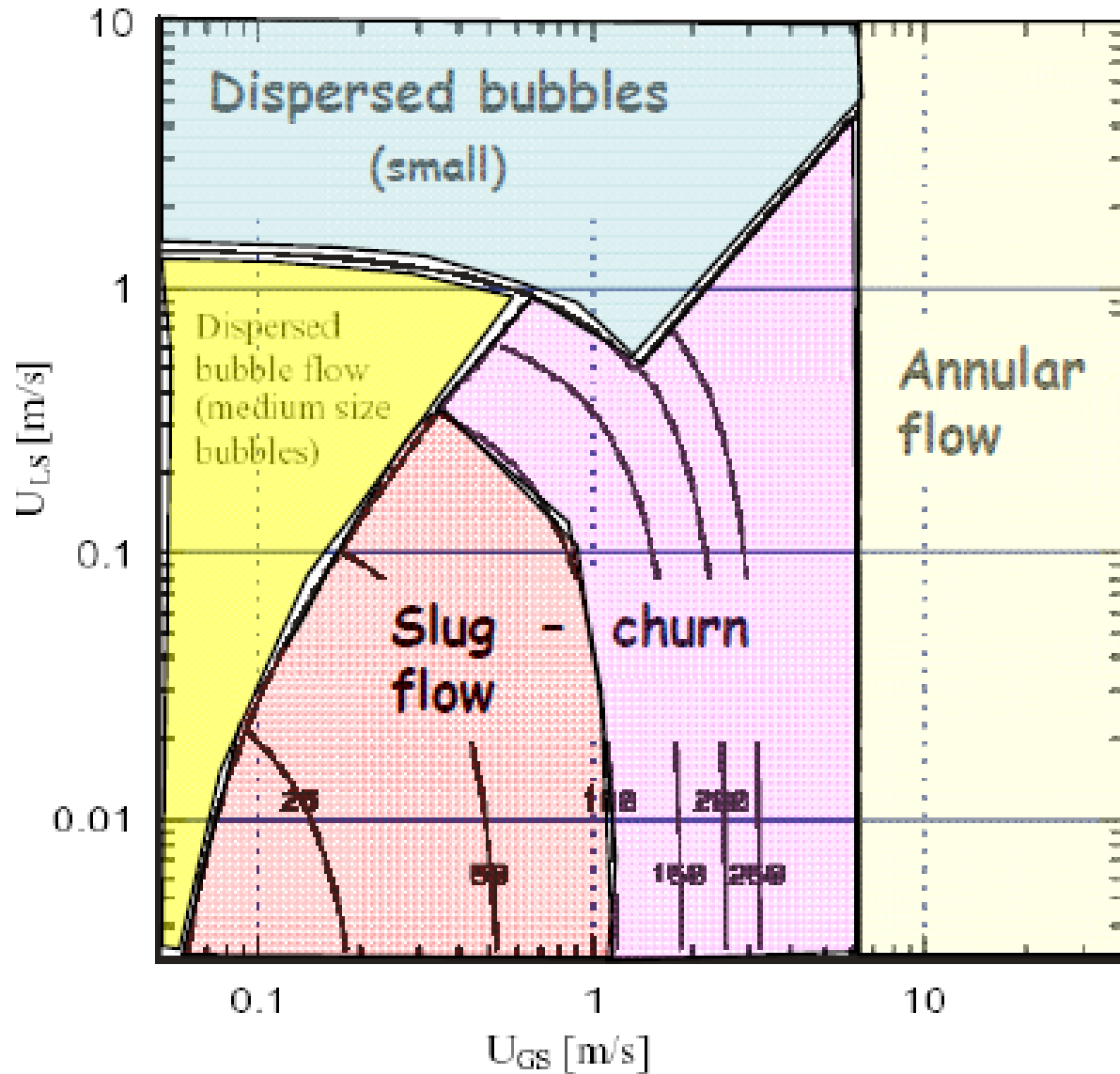
- In up-ward vertical pipeline



# Flow regime map – horizontal pipe



# Flow regime map – vertical pipe



# Hydrate

- Hydrate

An ice-like solid that forms when

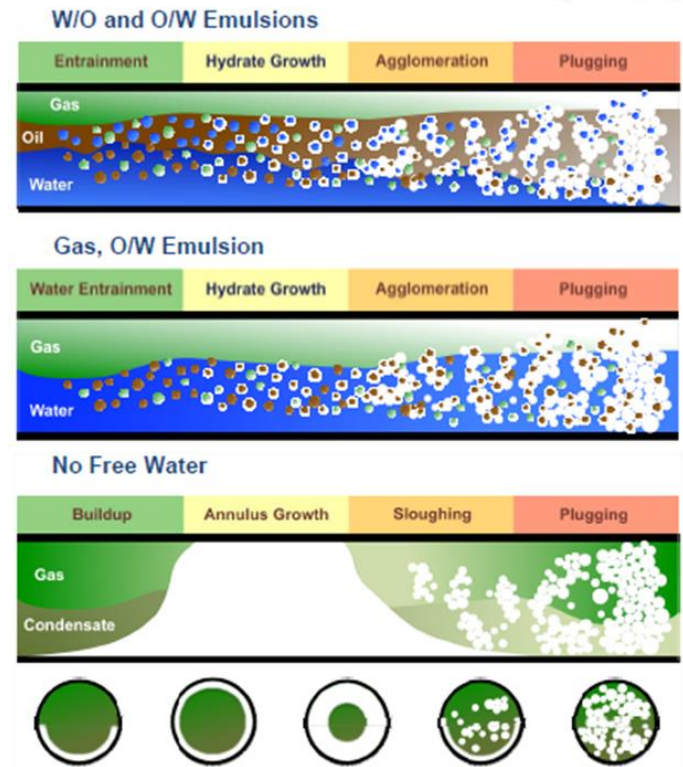
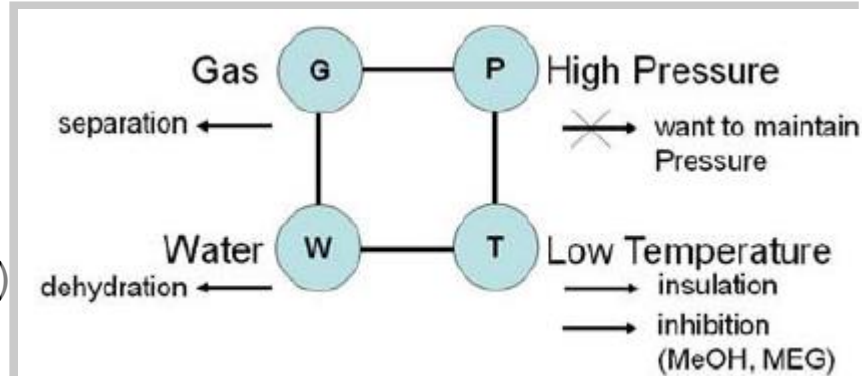
- : Sufficient water is present

- : Hydrate former is present (C1, C2, and C3)

- : Right combination of P and T

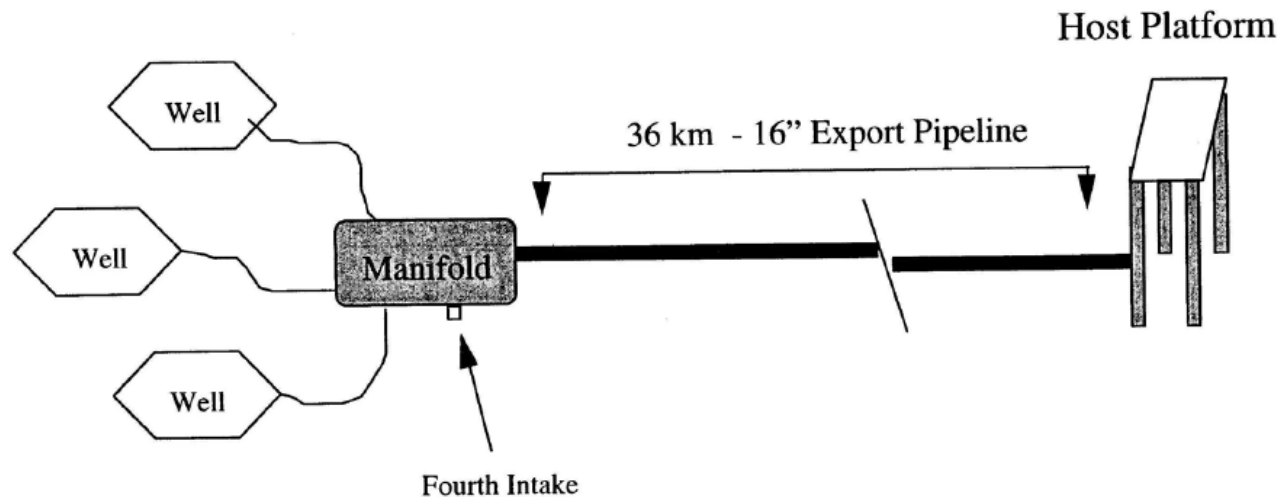
- Control strategy

- maintaining temperature above hydrate formation conditions (Insulation, DEH, etc)
- Decreasing the pressure outside the area of possible hydrate formation (for remediation)
- Removing the water (Subsea processing)
- Continuous injection of chemicals
  - : MEG is the most popular hydrate inhibition strategy for long distance tie-back systems

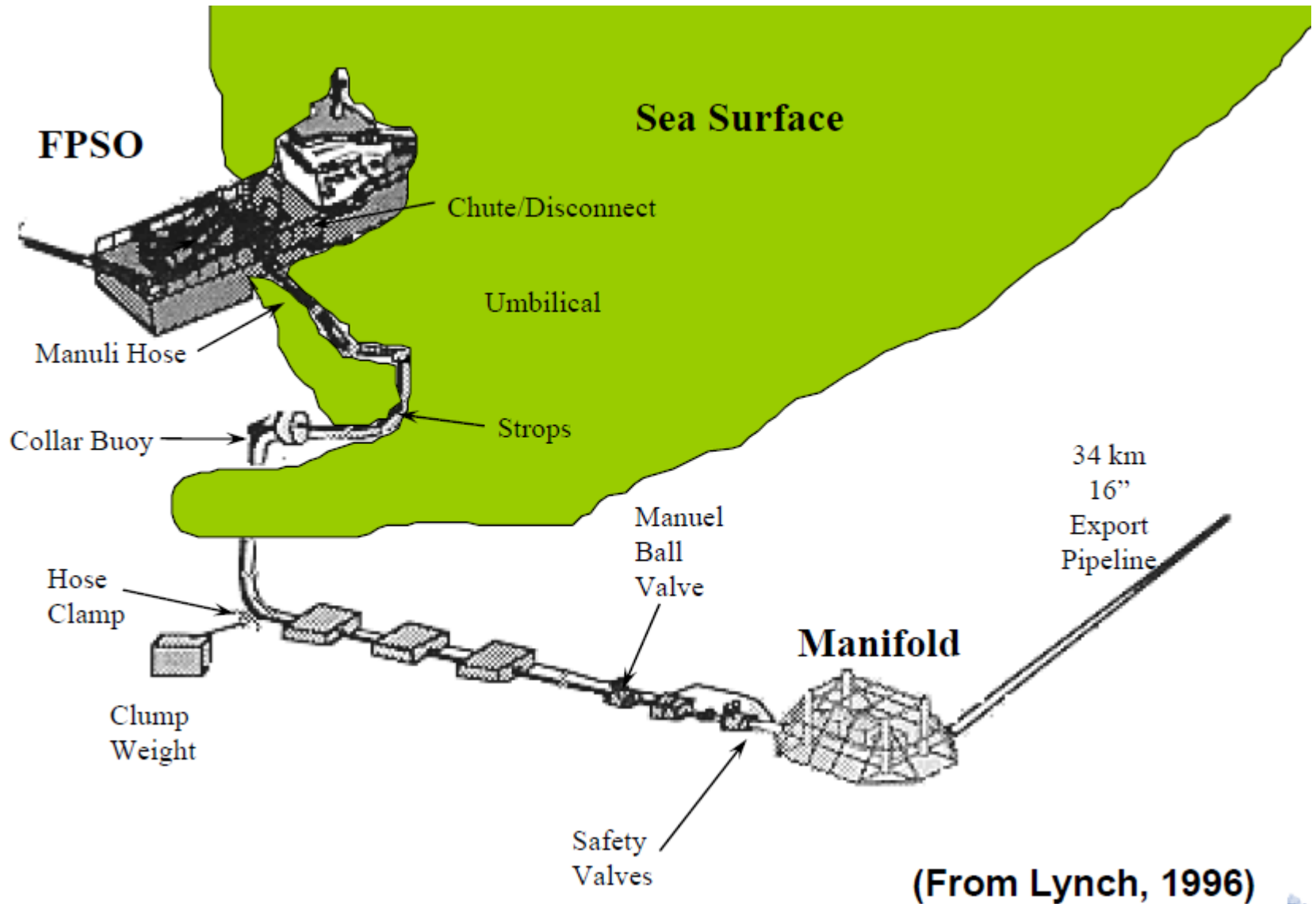


# North Sea Plug Case History

- 16inch, 22mile pipeline in UK sector
- MEG injection line had sheared
- 1.2 mile long plug
- Upstream of platform by <math><0.25</math> miles
- FPSO brought in from Stavanger
- Depressurized both sides of plug
- 8 weeks total downtime, \$3MM cost

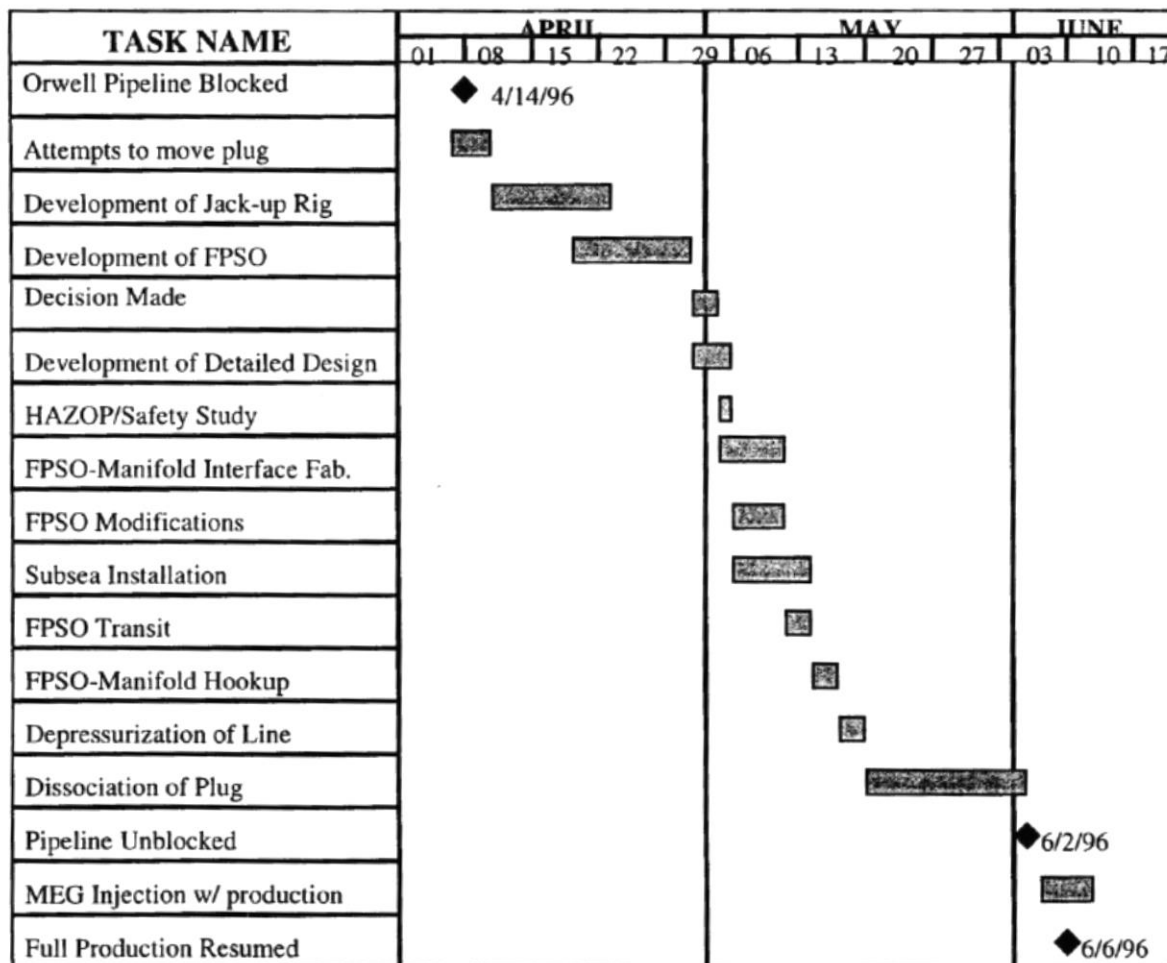


# Complete FPSO/Manifold Interface



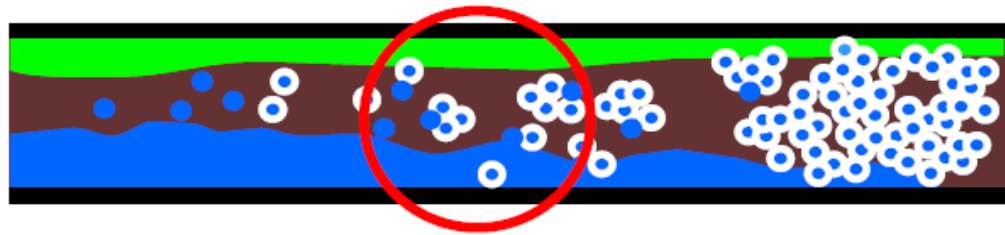


**Figure 71 - Schedule for Complete Plug Remediation**  
 (From Lynch, 1996)

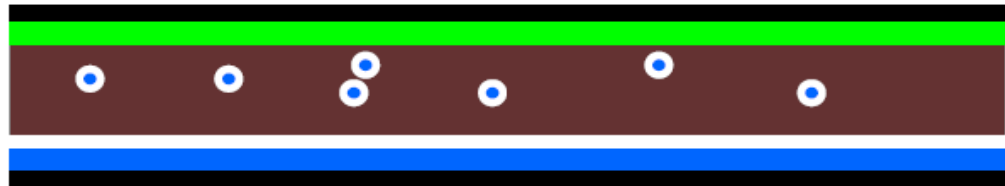


# Pipeline operating scenarios

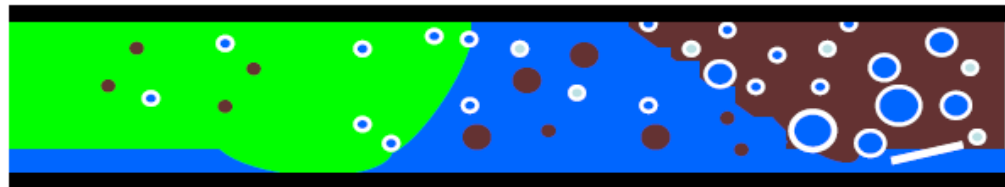
1. Normal Operation:



2. Shut-in:



3. Restart:



**Question: When and where will hydrates form?**

# Hydrate mitigation

- Insulation
  - Pipe-in-pipe
  - Wet Insulation
- Active heating systems
  - Hot Water
  - Electric
- Subsea Chemicals Injection
  - Methanol, MEG
  - LDHI
- Flowline Pressure Reduction

# Thermodynamic Hydrate Inhibitors (THIs)

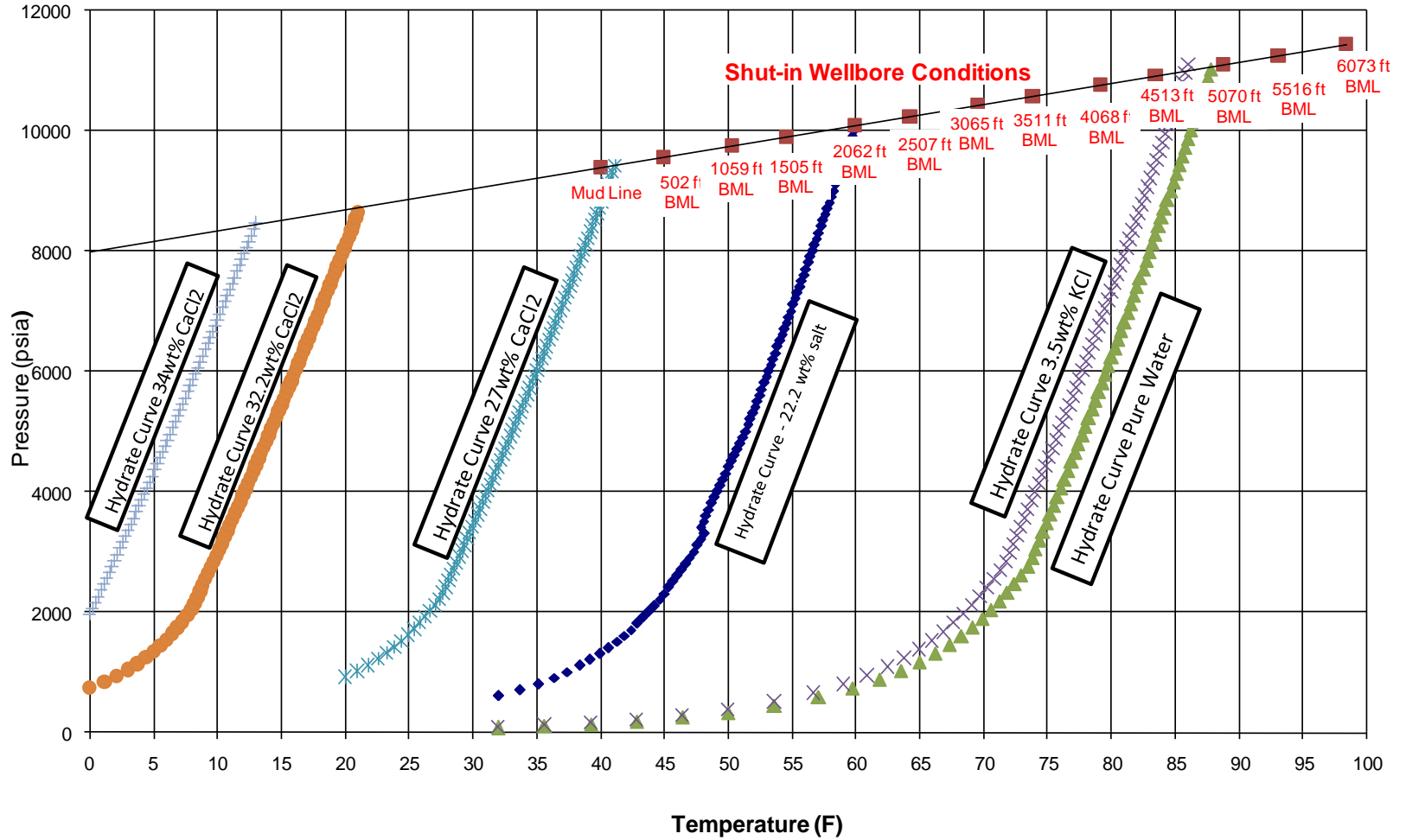
- Methanol

- : Low cost
- : Low viscosity
- : No fouling
- : **More toxic**
- : **Too little can be worse than none at low levels**
- : **Inefficient to recover**
- : **Reduce hydrocarbon sales value**
- : **High loss to gas phase**

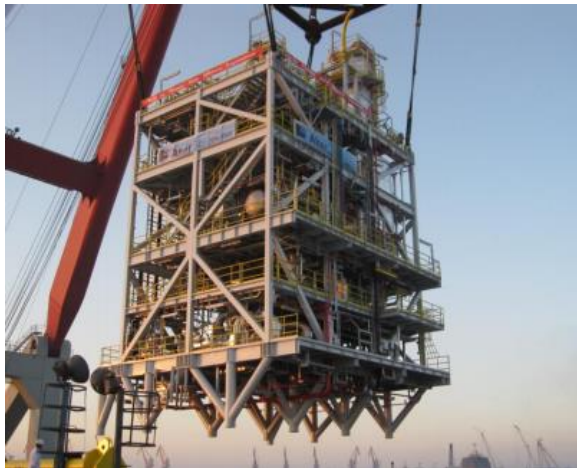
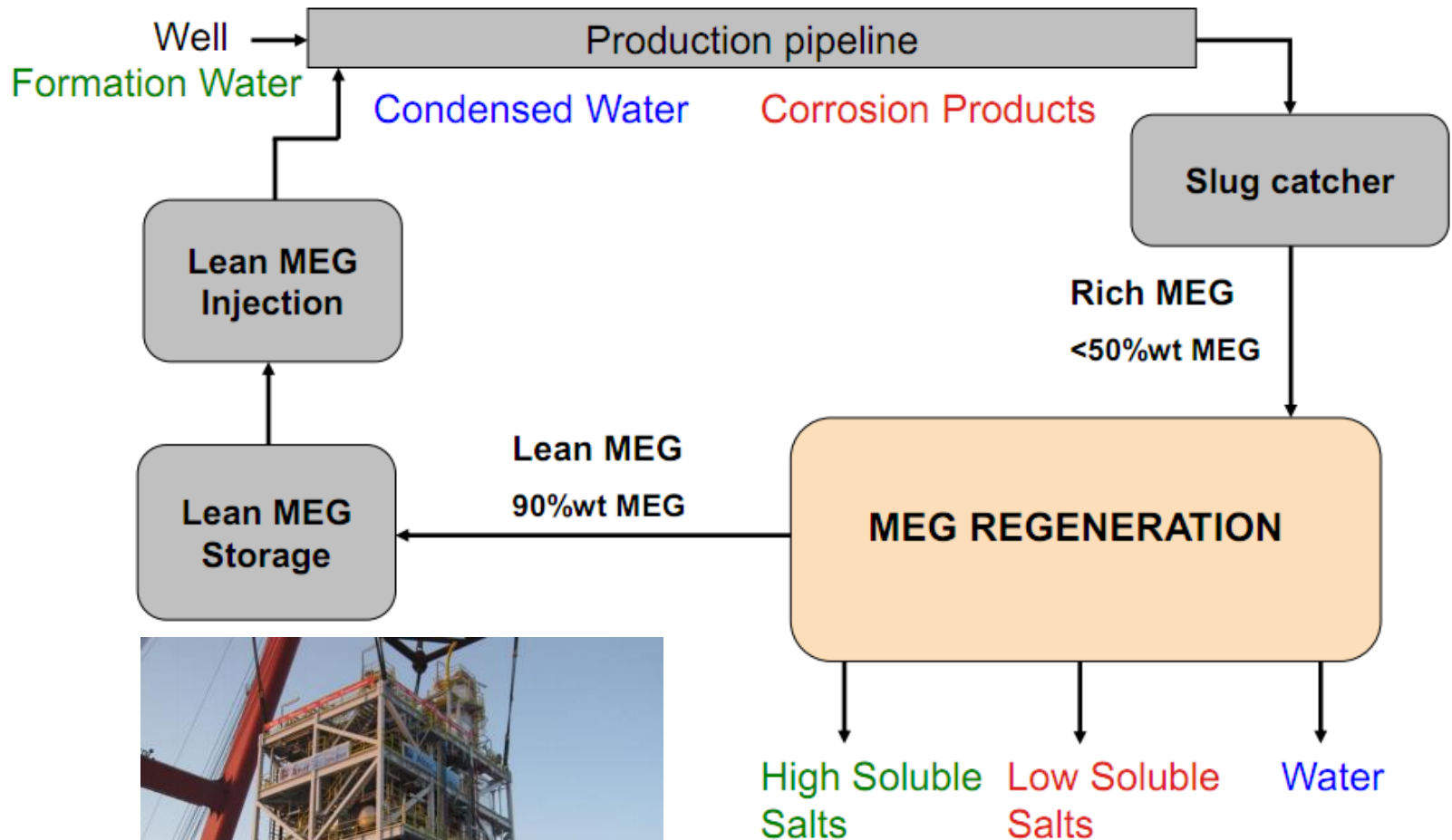
- MEG

- : Less toxic
- : Under-treating not as bad
- : Efficient to recover
- : Does not affect hydrocarbon value
- : Loss to gas phase negligible
- : **High viscosity**
- : **Salts precipitation**
- : **Fouling by salt deposition**

## Hydrate Curve and Wellbore Shut-in Conditions



# MEG Regeneration Unit



MRU for Santos FPSO

# Wax

- Paraffinic hydrocarbons (candle?)

- : A solid paraffinic hydrocarbon which precipitate from a produced fluid

- : Forms when the fluid temperature drops below the Wax Appearance Temperature (WAT)

- : Melts at elevated temperature (20°F above the WAT)

- Control strategy

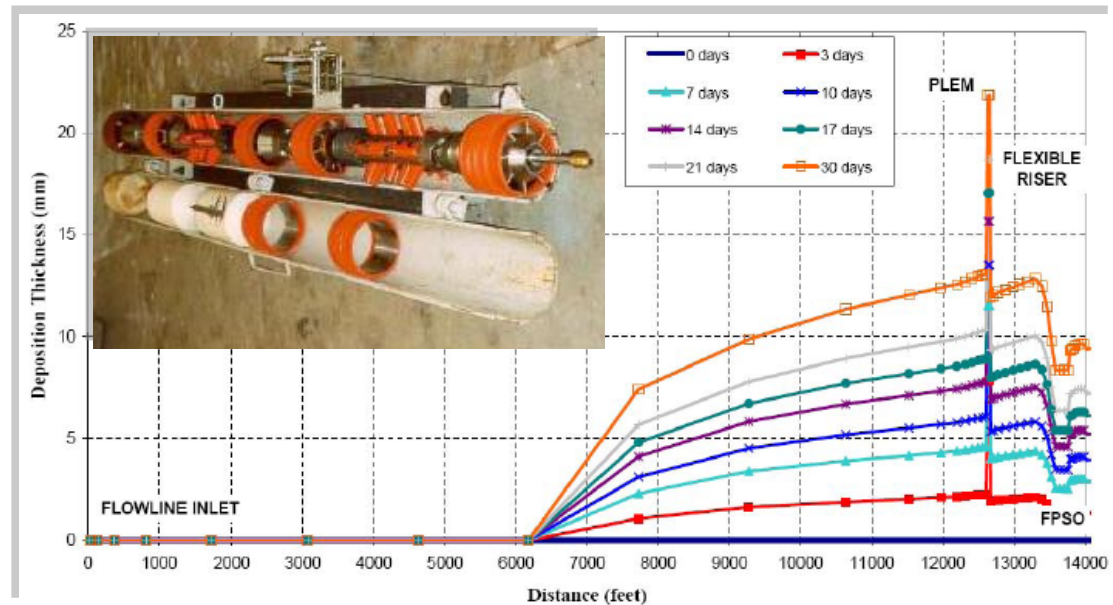
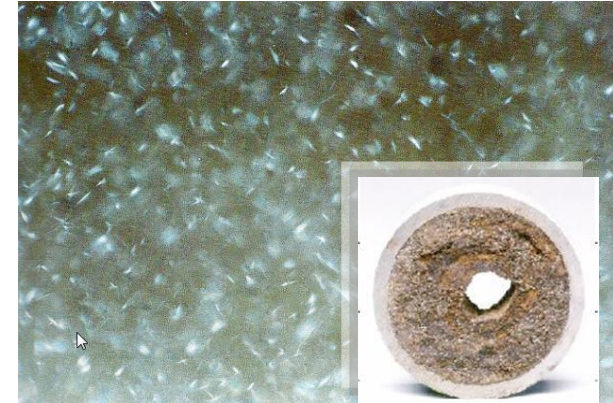
- : Rate of deposition can be predicted to calculate pigging frequency

- : Flowline insulation

- : Wax inhibitor

- : Major factors

- WAT
- Fluid temperature
- Overall U-value
- Deposition rate

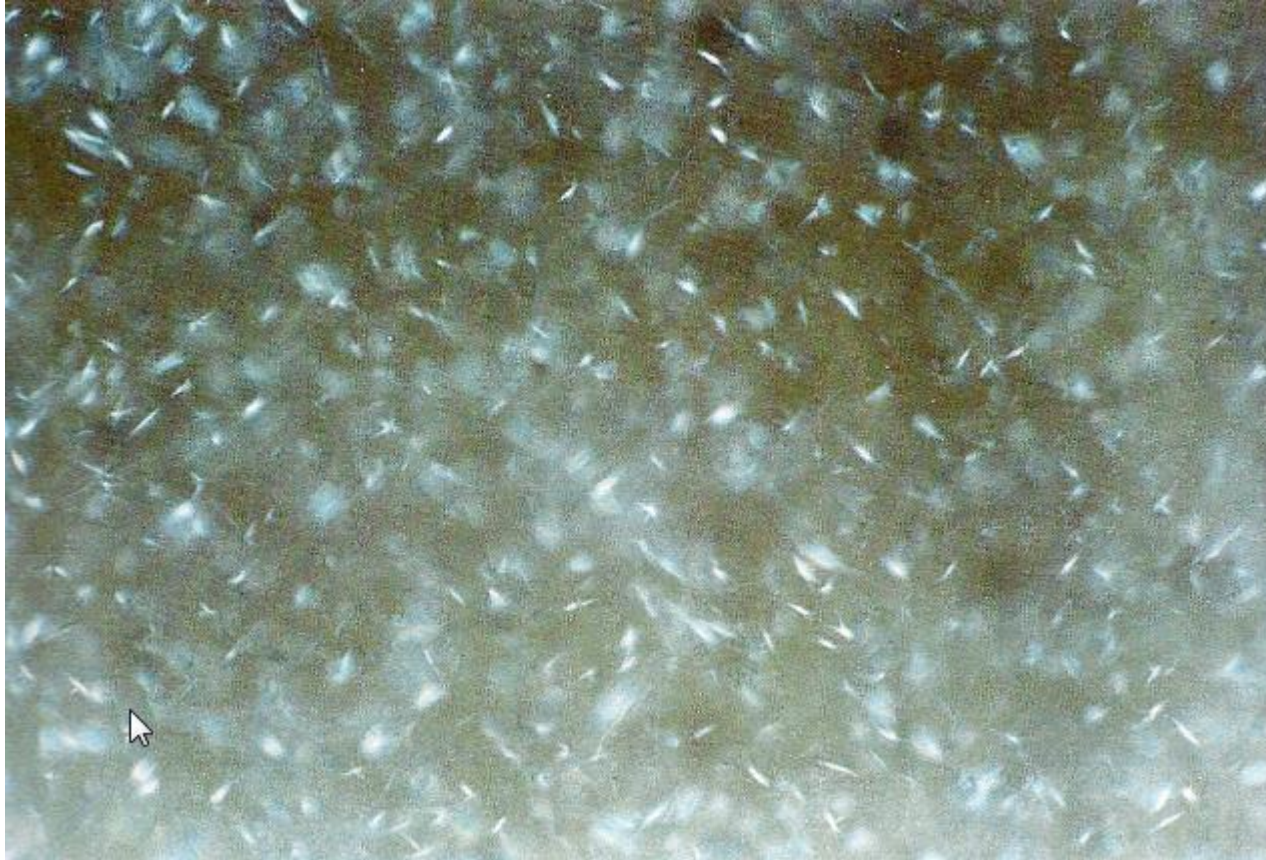


# WAT determination

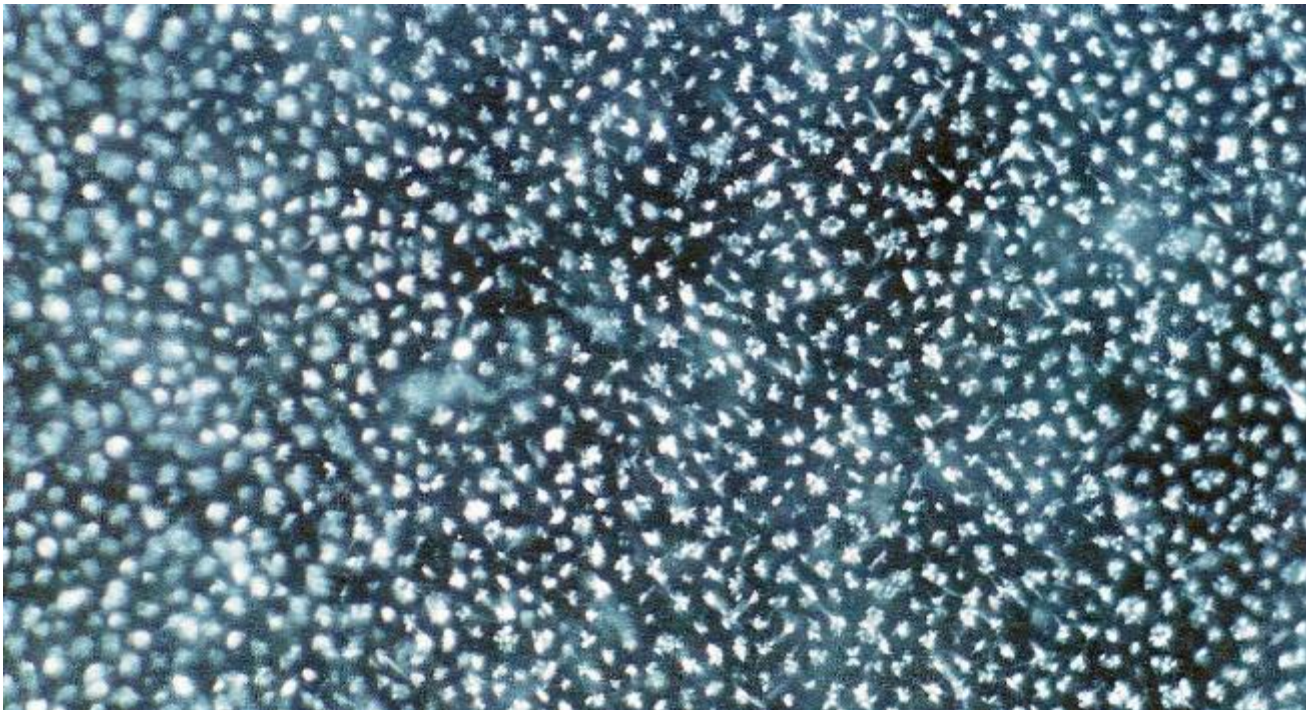
- The wax appearance temperature (WAT) or cloud point is the most important parameter relating to wax formation.
- There are a number of generally accepted measurement techniques, each with advantages and disadvantages.
  - CPM - Cross Polarized Microscopy
  - NIR - Near Infra Red Absorption Reflection
  - DSC - Differential Scanning Calorimetry
  - Cold Finger
  - Filtration
- Cloud point is a crystallization temperature and therefore kinetics will influence any measurement. Thus, it is strongly recommended that cloud point be determined using two different techniques. With care, the cloud point can be determined to an accuracy of 5 °F.



# WAT by Cross Polar Microscopy



# Modification of Wax Crystals in STO by a Wax Inhibitor



# How do wax inhibitors work?

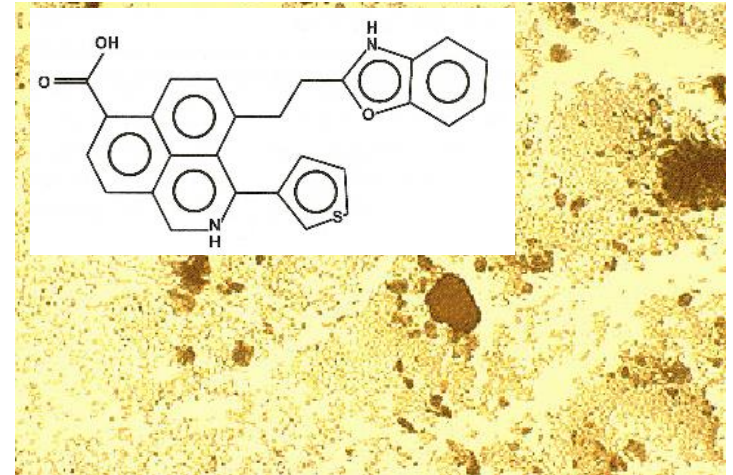
- Crystal modifiers
  - Co-crystallize with wax to prevent wax crystal structures from forming on pipe wall
  - Modifies wax crystals to improve flow characteristics and weaken adhesion
- Dispersants/Surfactants
  - Coat wax crystals to prevent growth
  - Alter wetting characteristics to minimize adhesion to pipe wall or other crystals

- Pour point depressants/Flow Improvers
  - Modify wax crystal structure
  - May reduce viscosity and yield stress but may not reduce rates of wax deposition
- Drag Reducing Agents
  - Commercially available from chemical companies for single phase
  - Can significantly reduce pressure loss by reducing friction and secondary flows
  - Must function under multi-phase flow conditions within wide temperature interval

# Asphaltenes and Scales

- Asphaltenes

- : The heavy polar aromatic fraction
- : Resulting blockage and formation damage
- : The main causes are
  - A decrease in the system pressure
  - Mixing of incompatible crude oils
- : Require asphaltene inhibitor injection



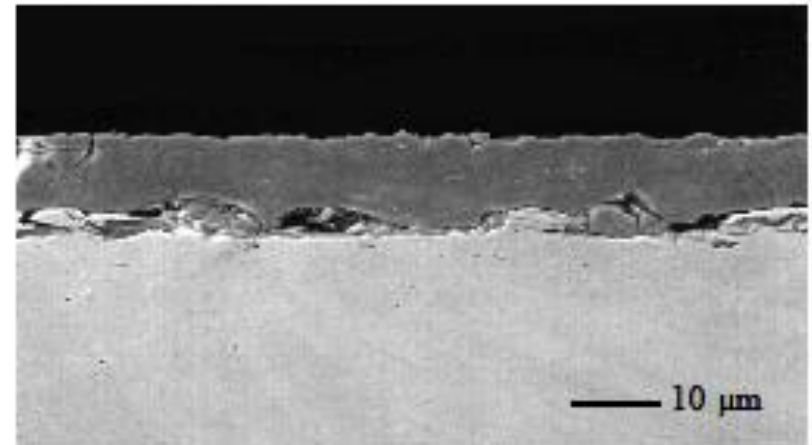
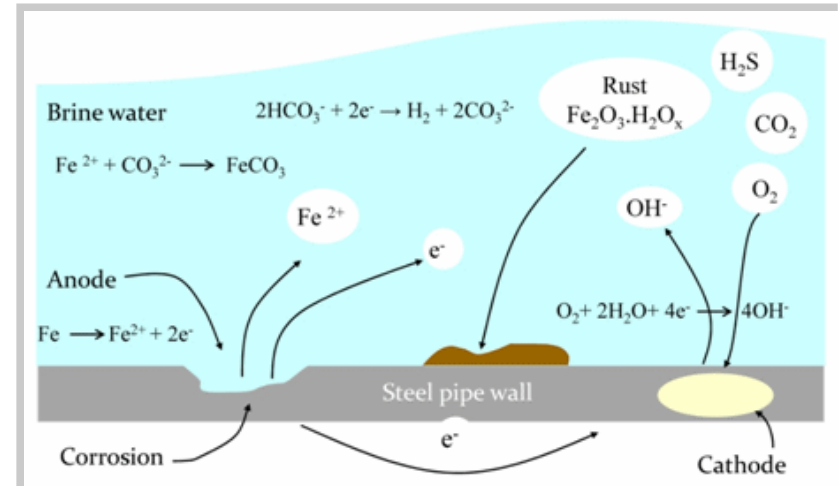
- Scales

- : The carbonates or sulphates of calcium, strontium and barium
- :  $MgCO_3$ ,  $CaCO_3$  scaling issues in the MEG system
- : Require scale inhibitor injection



# Corrosion

- Loss of metal
  - : Metal loss caused by corrosive water
  - :  $\text{Fe} = \text{Fe}^{++} + 2\text{e}^-$
  - : Variables
    - Material
    - $\text{H}_2\text{S}$  and  $\text{CO}_2$  level in fluids
    - Water composition
- Control strategy
  - : Alter chemical environment
    - Oxygen scavengers
    - Sulfide scavengers
  - : Alter reactive surface of metal
    - pH control to form protective film
    - Corrosion inhibitors
    - Polymeric liners to flowlines



protective iron carbonate film formed at high pH (right).

# Internal corrosion

- Sweet corrosion occurs in systems containing only carbon dioxide or a trace of hydrogen sulfide ( $\text{H}_2\text{S}$  partial pressure < 0.05 psi).
  - : When  $\text{CO}_2$  dominates the corrosivity, the corrosion rate can be reduced substantially under conditions where iron carbonate can precipitate on the steel surface and form a dense and protective corrosion product film. This occurs more easily at high temperatures or high pH values in the water phase.
- Sour corrosion occurs in systems containing hydrogen sulfide above a partial pressure of 0.05 psia and carbon dioxide.
  - : When  $\text{H}_2\text{S}$  is present in addition to  $\text{CO}_2$ , iron sulfide films are formed rather than iron carbonate as a protective films.
- Localized corrosion with very high corrosion rates can occur when the corrosion product film does not give sufficient protection, and this is the most feared type of corrosion attack in oil and gas pipelines.

# Corrosion Predictions

- Temperature;
- CO<sub>2</sub> partial pressure;
- Flow (flow regime and velocity);
- pH;
- Concentration of dissolved corrosion product (FeCO<sub>3</sub>);
- Concentration of acetic acid;
- Water wetting;
- Metal microstructure (welds);
- Metal prehistory.



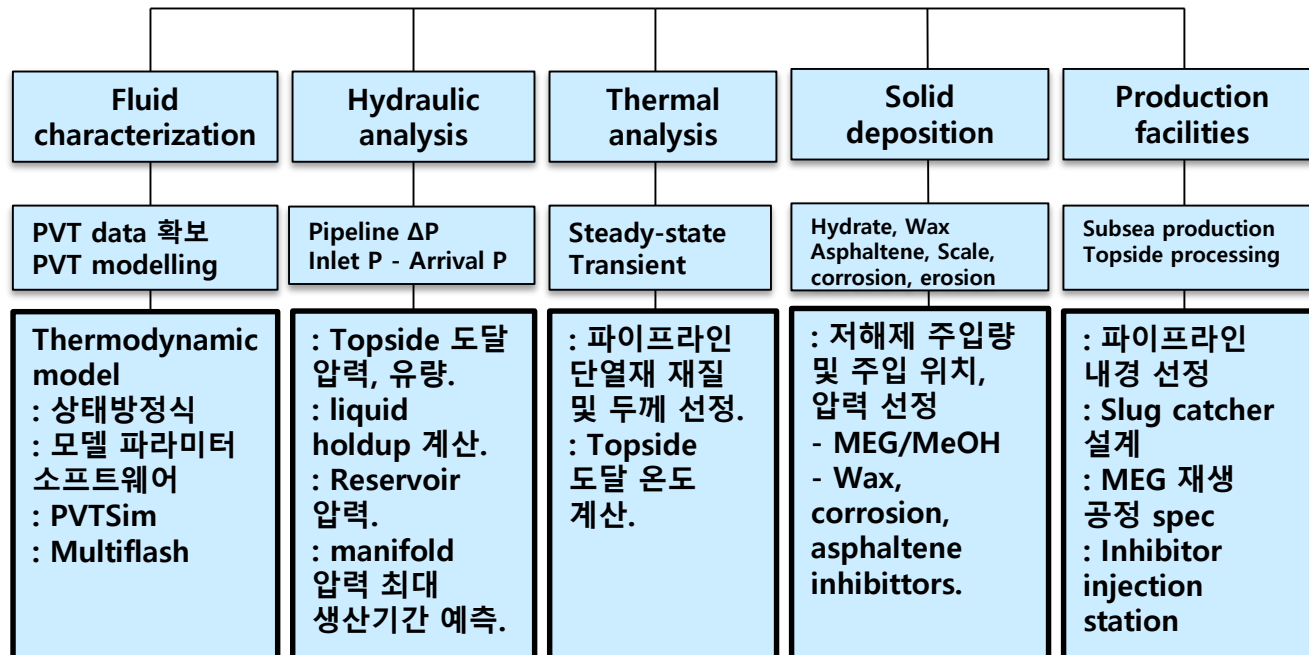
# Example treating chemicals properties and levels

Treating Chemical (& Injection location)	Viscosity at 40 oF (cP)	Density at 14.7 psia (g/cc)	P50 Treatment levels	
			(ppm-V)	basis
Paraffin Inhibitor (at tree)	4.1 @ 14.7 psia 8.2 @ 10,000 psia	0.879 @ 60 oF	150	Oil
Scale Inhibitor (down hole)	37.8 @14.7 psia 41.5@10,000 psia	1.324@ 77oF	20	Water
Asphaltene Inhibitor (downhole)	12.4 @ 14.7 psi 35.3 @ 10,000 psi	0.926@ 60oF	250	Oil
Corrosion Inhibitor (at tree)	83.1 @ 14.7 psia 187.7 @ 10,000 psia	0.999@ 70oF	25	Oil + Water

Note: Treating chemicals from different suppliers (and different formulations from the same supplier, for the same function) can have greatly different physical properties and treatment levels.

# Summary – Flow Assurance

- Simulation of subsea systems becomes an important discipline for design and operation of offshore platforms
- It demands comprehensive understanding of multiphase flow and solid deposition.
- The simulation results are linked together in matrix form, thus stage work process is required.





Thank you!

# Flow Assurance framework

## Subsea Flow Assurance 해석 기술

Step 1

### Establish Design Basis

- Reservoir Behavior
- Production Rates
- Fluid Characterization
- Flowline Routing
- Environmental Condition
- Host Facility

Step 2

### Flow System Thermal-Hydraulic Design & Fluid Behavior

#### Thermal & Hydraulic

Model Wells

Model Flowline

Select Tubing & Flowline Diameter and # of Flowline, and Insulation

Start up/Warm up/Shut down/Cool down/  
Turn down/Ramp up/Depressurization/Slugging

#### Assess Chemistry

Hydrate, Wax, Asphaltene, Scale

Prediction Control Remediation

Assess Transient Thermal-Hydraulics

Step 3

### Interface with Mechanical Design

Flowline, Pipeline & Riser  
Subsea Equipment  
Umbilical  
Wellbore

### Operating Strategy

Procedures  
Valve Sequences  
Pump Sequences  
Chemical Injection Rates  
Activity Durations

### Topside Interface Requirement

Processing Capability  
Processing Pressure/Temperature  
Metering  
Storage Volume  
Export Requirements  
Chemical Injection Pump  
Flare Requirements  
Utility & Emergency Power  
Surge/Slug Volume & Control

No

Reservoir,  
Flow System  
and Host  
Design  
Compatible?

Yes

### Topside Design

Providing Design  
Basis of Topside  
Process

To  
Topside

# Chapter 1. Flow Assurance design basis

- Information needed to initiate an offshore FA study
  1. Drill Centers Description
  2. Flowlines layouts and route topography
  3. Bathymetry
  4. Flowlines, Risers and Flexible Catenaries Descriptions
  5. Reservoir Fluids Properties and Compositions
  6. Stock Tank Oil Properties/Composition
  7. Injection Water and Injection Gas Properties/Compositions
  8. Depletion Plans – Annual Data - Overall and per Well
  9. Production Wells' Properties
  10. Injection Wells' Properties
  11. Well Completions
- Required reports
  - : Field development plan
  - : Basis of well design
  - : Flow assurance design premise
  - etc.

- Environmental and Metocean Data
  - : Air temperature profile, Maximum wind velocity
  - : Water temperature profile, Seawater currents
  - : Soil temperature profile, Soil thermal conductivity
  - : Sand production estimates
- Design philosophy and Criteria
  - : Functional requirements
  - : Choice of significant years of production
  - : Erosional velocity criteria
  - : Maximum velocity for water injection lines and gas injection lines
  - : Maximum velocity and maximum sand through manifolds
  - : Hydrate dissociation curve
- Process Facilities Interface
  - : Temperature and pressure conditions
  - : Flexibility
  - : Description of Topside system
- Approved Simulation Packages

# Chapter 2. Flow Assurance study

## 1. System description

- Flowlines
- Risers
- Umbilicals
- Wellbore, Jumpers, Manifolds, PLETs, Flexibles, etc.
- Topside functional requirements

## 2. Steady state flow

- Thermal & hydraulics
- Hydrates
- Wax
- Confirming the suitable line sizing for production systems  
: Flowlines, Risers, Umbilicals, Jumpers, Spools, etc.
- Analyzing the pumps and compressors requirements

### 3. Shutdown

- : Ramp down analysis
- : Cool down – CDT analysis, liquid holdup
- : Hydrates – DTHYD analysis
- : Wax (gel point) – WAT arrival time
- : Depressurization analysis
- : Dead oil displacement analysis

### 4. Start up

- : Thermal-hydraulics – Liquid slugging and max. surge analysis
- : Warm up – time to reach  $CDT > 0$  (engineering margin:  $3^{\circ}\text{C} + \text{CDT}$ )
- : Hydrates – Precaution for cold restart and confirm the inhibition concentration before opening choke
- : Wax – Precaution for cold restart and gelling during the extended shut-in. Confirm the pigging requirement before opening choke.



## 5. Pigging

: Analyzing the amount of wax, liquid holdup, sand deposition

## 6. Depressurization of flowlines

: Coupled with shut down study and confirm the max liquid production rate

## 7. Remediation

: Develop the strategies for hydrates, wax, etc

## 8. Sand deposition

## 9. Corrosion/Erosion

Appendix 1 – Diagrams of the flow system (field architecture)

Appendix 2 – Well performance data

Appendix 3 – OLGA simulation studies

# Chapter 3. Operational Procedures

## 1. Steady state flow

- : Thermal-hydraulics

- : Hydrates

- : Wax

## 2. Shutdown

- : Cool down

- : Hydrates

- : Wax (gel)

## 3. Start up

- : Thermal-hydraulics

- : Warm up

- : Hydrates

- : Wax (gel)

4. Valve sequences for shutdown, start up, ramp up & down, etc.

5. Activity durations for cool down, displacement, warm up, etc

6. Pump sequences for displacement, gas & water injection etc

7. Chemical injection rates

8. Remediation strategies (hydrate, wax, asphaltene, etc)

# Chapter 4. Production system design

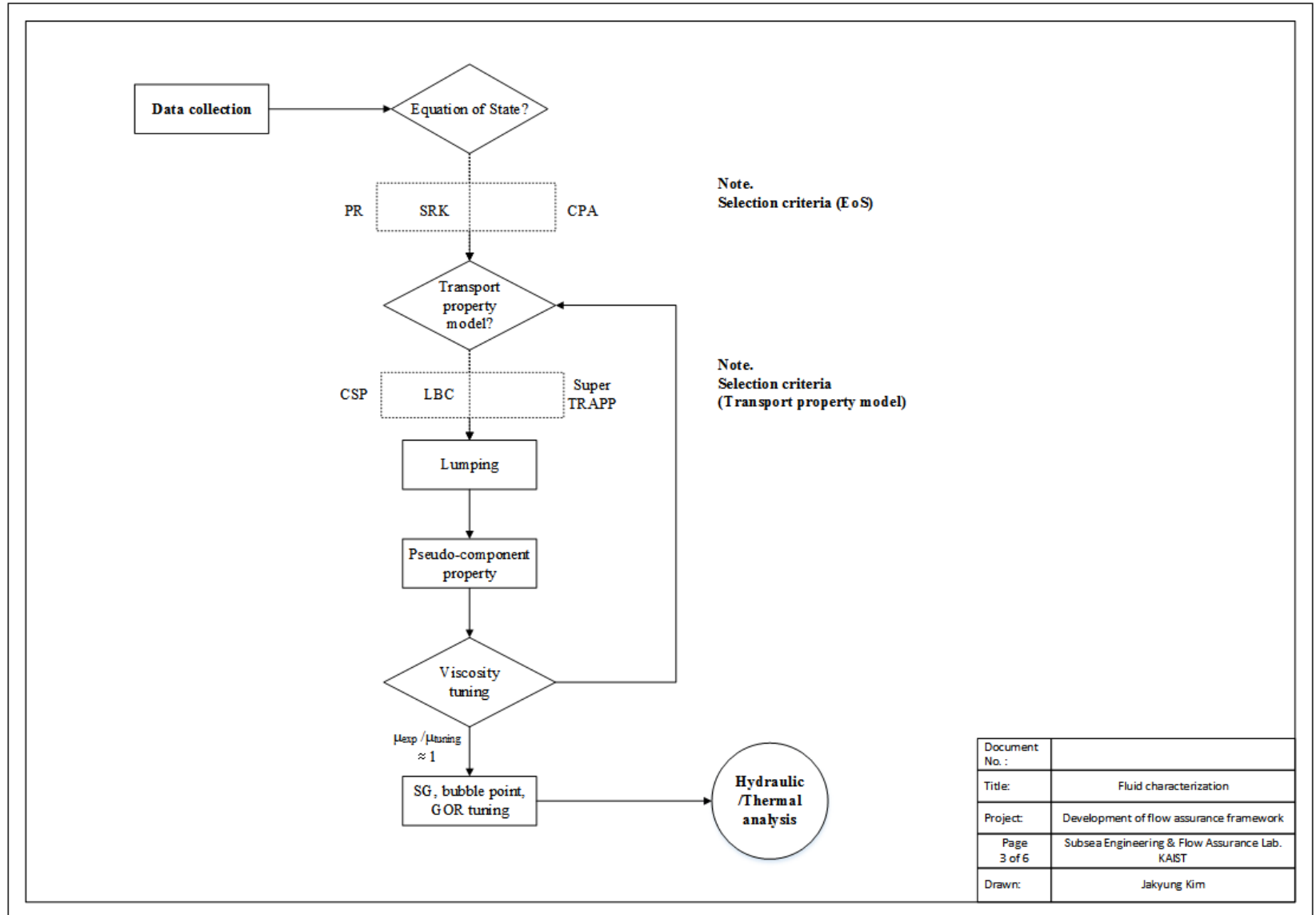
## 1. Interface with host facility

- : Sizing of flowline, jumpers, spools, and risers
- : Insulation requirement
- : Subsea equipment – DEH, cooling section, etc
- : Umbilicals
- : Wellbore

## 2. Host facility design

- : Processing capabilities
- : Arrival pressure and temperature
- : Slug handling capacity
- : Topside blowdown
- : Flare gas/liquid capacities
- : Gas lift/Gas injection
- : Water injection
- : Storage capacities – products, chemicals, etc.
- : Chemical injection
- : Export requirements (GEP inlet pressure etc.)

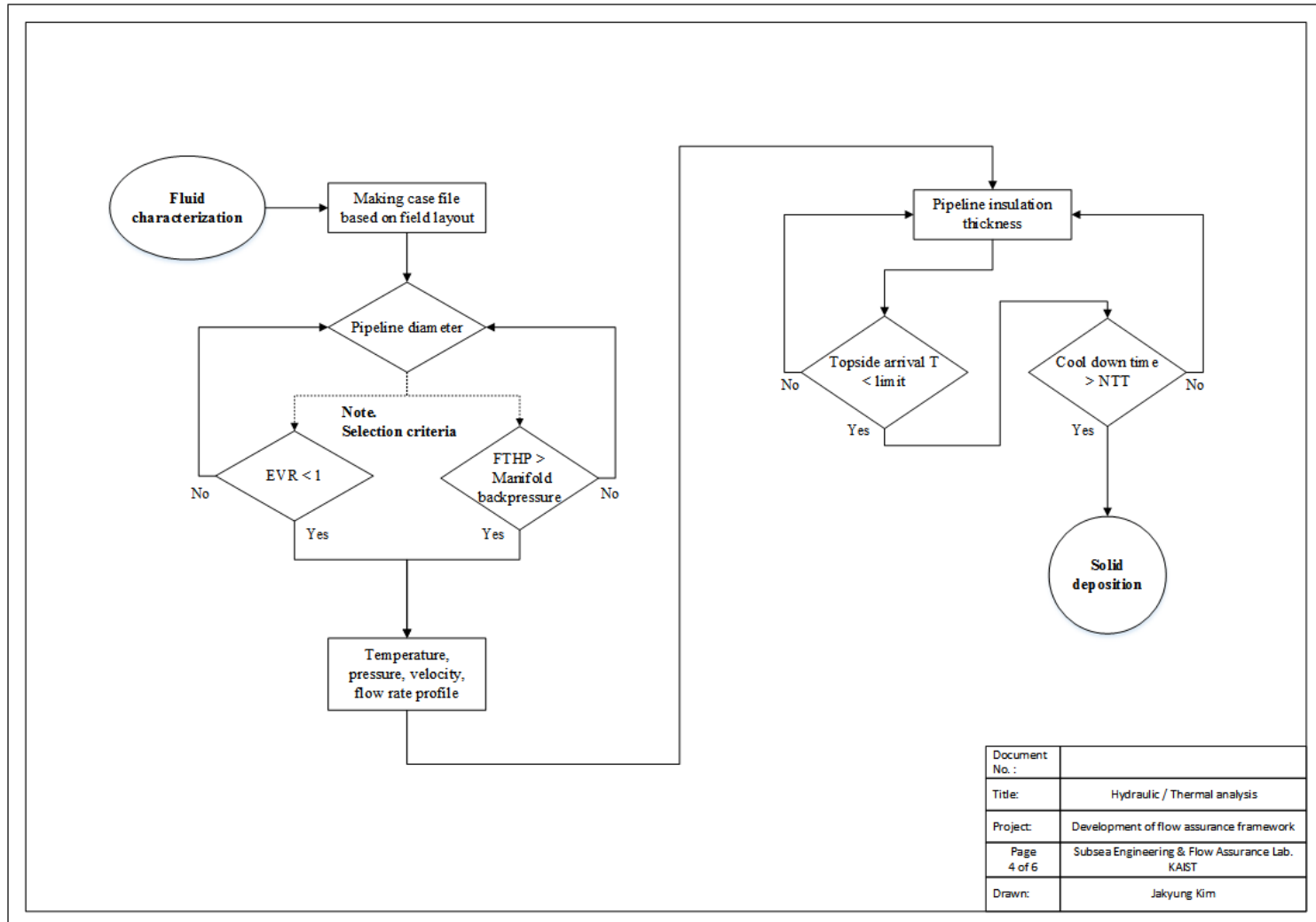
# Note 1. Fluid characterization



Document No. :	
Title:	Fluid characterization
Project:	Development of flow assurance framework
Page 3 of 6	Subsea Engineering & Flow Assurance Lab. KAIST
Drawn:	Jakyung Kim

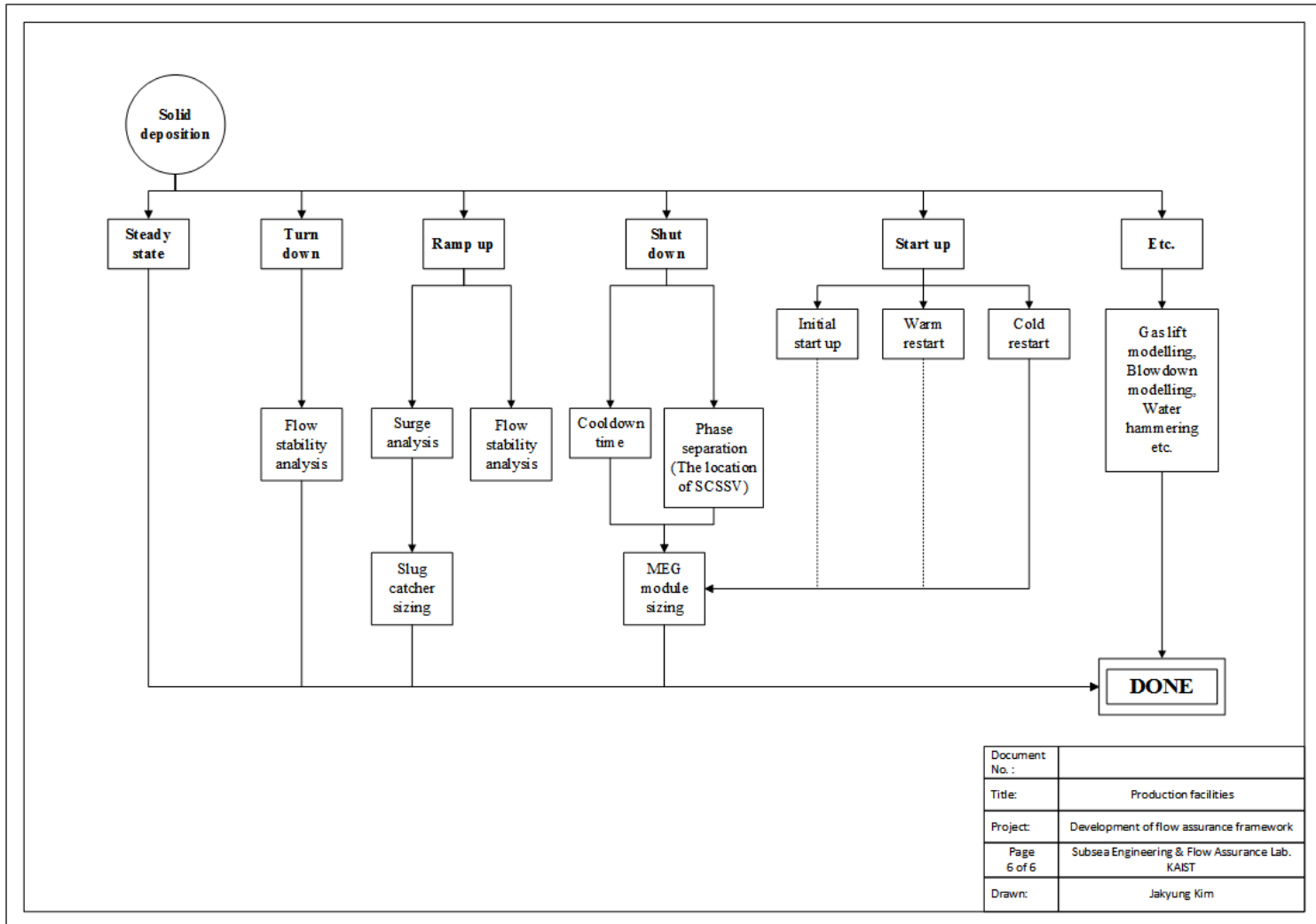
# Note 2. Multiphase flow simulation

- OLGA modeling – steady state



Document No.:	
Title:	Hydraulic / Thermal analysis
Project:	Development of flow assurance framework
Page 4 of 6	Subsea Engineering & Flow Assurance Lab. KAIST
Drawn:	Jakyung Kim

- OLGA modeling - transient

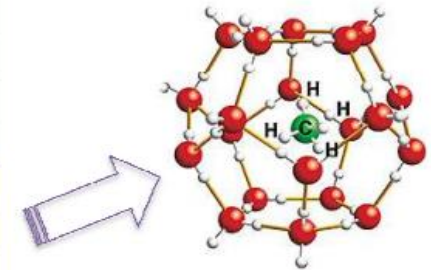


Document No.:	
Title:	Production facilities
Project:	Development of flow assurance framework
Page 6 of 6	Subsea Engineering & Flow Assurance Lab. KAIST
Drawn:	Jakyung Kim

# Note 3. Hydrate

- Gas hydrate may form in flowlines transporting hydrocarbon fluids in the presence of free water phase
- Hydrate prevention strategies
  1. Thermal management
    - : Insulation of flowlines to retain heat and to achieve cooldown time
    - : Incorporating DEH (direct electrical heating)
  2. Fluid composition management
    - : Dehydration to remove free water
    - : Subsea separation
  3. Inhibitor injection
    - : Shifting hydrate equilibrium curves
    - : MEG or MeOH
    - : LDHI

	Mol fraction
	Mol-%
CO2	1.66
N2	0.22
C1	89.94
C2	4.24
C3	2.03
iC4	0.48
nC4	0.58
iC5	0.25
nC5	0.18
C6	0.17
C7+	0.25



**Gas + Water  $\leftrightarrow$  Hydrate**

**Hydration formation  
=  $f$ (Compositions, P, T)**

# Note 4. Wax

- Paraffinic hydrocarbons

- : A solid paraffinic hydrocarbon which precipitate from a produced fluid
- : Forms when the fluid temperature drops below the Wax Appearance Temperature (WAT)
- : Melts at elevated temperature (20°F above the WAT)

- Control strategy

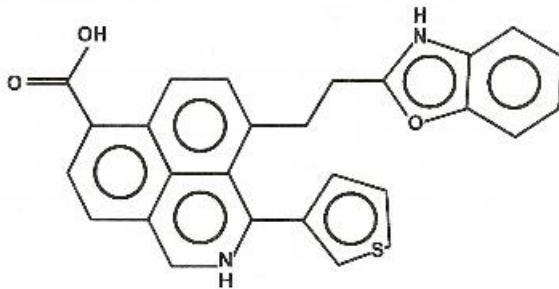
- : Rate of deposition can be predicted to calculate pigging frequency
- : Flowline insulation
- : Wax inhibitor
- : Major factors
  - WAT
  - Fluid temperature
  - Overall U-value
  - Deposition rate





# Note 5. Asphaltene

- Asphaltenes are the most heavy polar/aromatic compounds. They are not really soluble in most oils but exist as colloidal suspensions in the oil phase under reservoir condition.
- Asphaltenes carry the bulk of the inorganic component of crude oil, including sulfur and nitrogen, and metals such as nickel and vanadium.
- All oils contain a certain amount of asphaltene. Asphaltenes only become a problem during production when they are unstable.



H/C = 0.8 - 1.4

Molecular weight:

depends on solvent and concentration

monomer = 500 - 1000

micelles = 1000 - 5000

Heteroatoms: acting as polar functional group

C=80-85wt% (50-60 wt% aromatics),

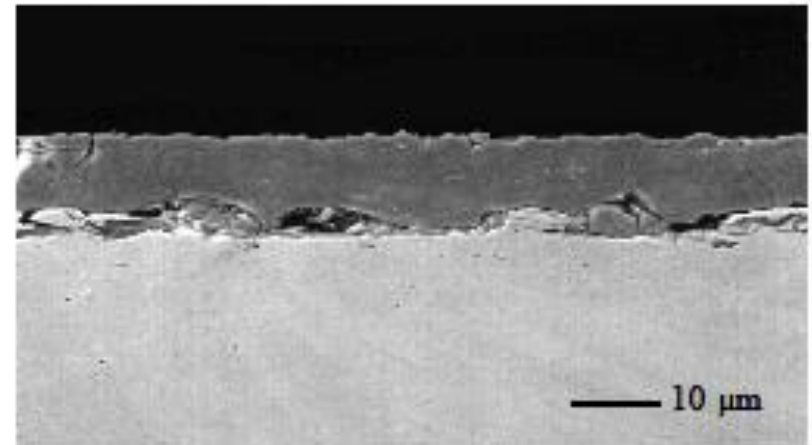
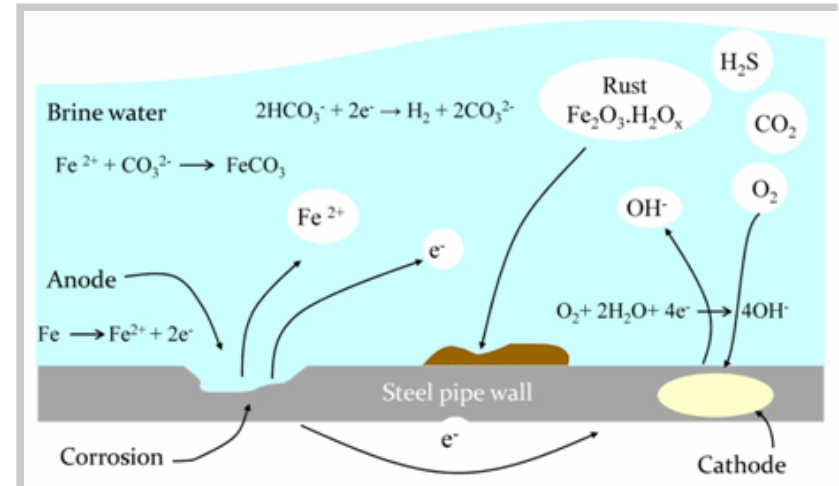
H=7-10 wt%, S=0.5-10 wt%; N=0.6-2.6 wt%;

O=0.3-4.8 wt%

Metal elements: Ni, V, Fe

# Note 6. Corrosion

- Loss of metal
  - : Metal loss caused by corrosive water
  - :  $\text{Fe} = \text{Fe}^{++} + 2\text{e}^-$
  - : Variables
    - Material
    - $\text{H}_2\text{S}$  and  $\text{CO}_2$  level in fluids
    - Water composition
- Control strategy
  - : Alter chemical environment
    - Oxygen scavengers
    - Sulfide scavengers
  - : Alter reactive surface of metal
    - pH control to form protective film
    - Corrosion inhibitors
    - Polymeric liners to flowlines



protective iron carbonate film formed at high pH (right).

# Note 7. Scale

- Scale is a deposit from precipitated mineral components in formation water. This is in contrast with waxes and asphaltenes, which deposit from crude oil.
- The solution is said to be saturated when the concentration of the solute is high enough such that it will no longer remain in solution at a specified temperature and pressure.
- The saturation index is defined as:  $SI = \log([Me][An]/K_{sp})$   
SI < 0: Non-Scaling, SI = 0: Equilibrium, SI > 0: Scaling Tendency  
Where:  
[Me] = molality of:  $Ca^{2+}$ ,  $Mg^{2+}$ ,  $Ba^{2+}$ ,  $Sr^{2+}$  or  $Fe^{2+}$   
[An] = molality of  $CO_3^{2-}$ ,  $SO_4^{2-}$ , or  $S^{2-}$   
K<sub>sp</sub> = solubility product = product of molalities at saturation