

Introduction to Nuclear Fusion

Prof. Dr. Yong-Su Na

How to heat up a plasma?

Plasma Heating

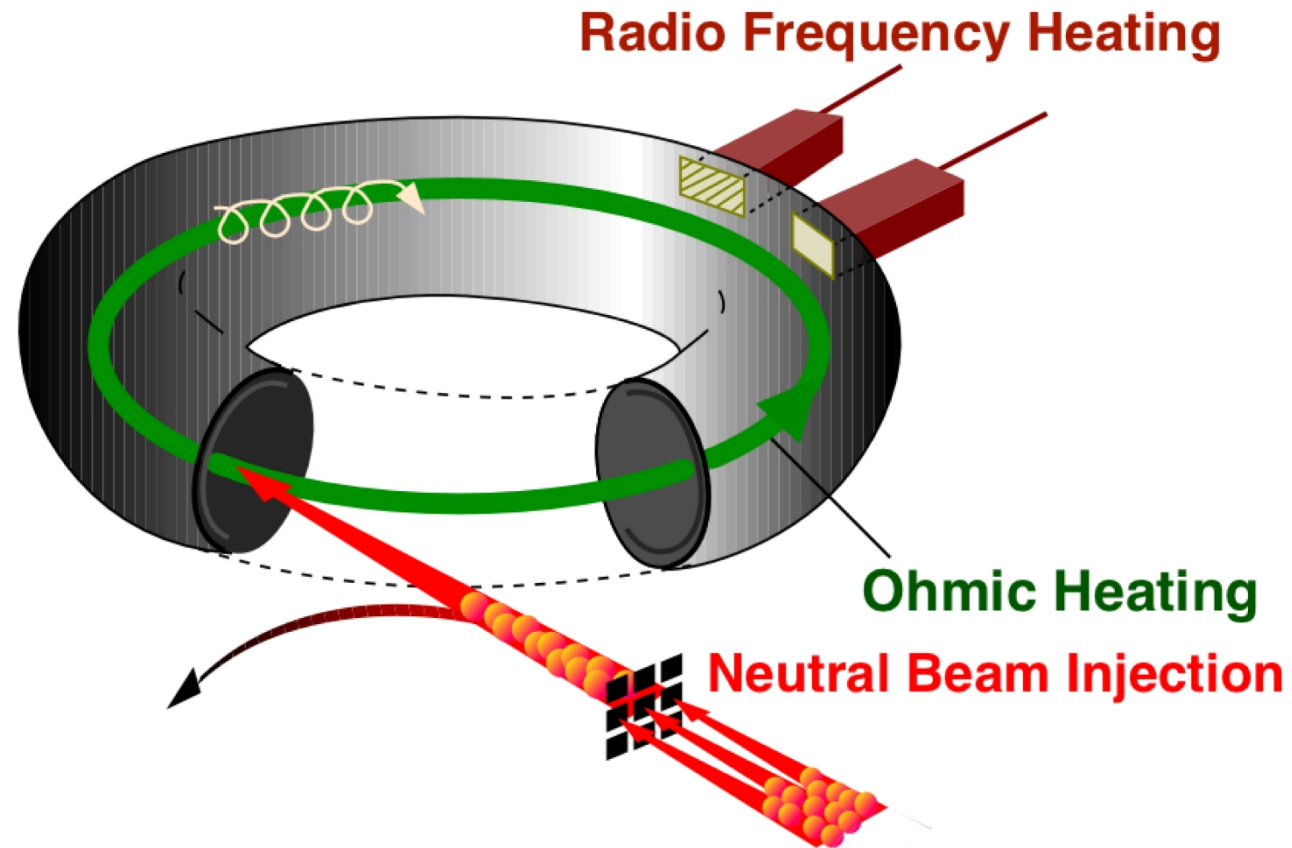

Ohmic heating

Ohmic Heating

SAMIK

Electric blanket



Auction (Korea)

- Intrinsic primary heating in tokamaks due to Joulian dissipation generated by currents through resistive plasma: thermalisation of kinetic energies of energetic electrons (accelerated by applied \mathbf{E}) via Coulomb collision with plasma ions
- Primary heating due to lower cost than other auxiliary heatings

Ohmic Heating

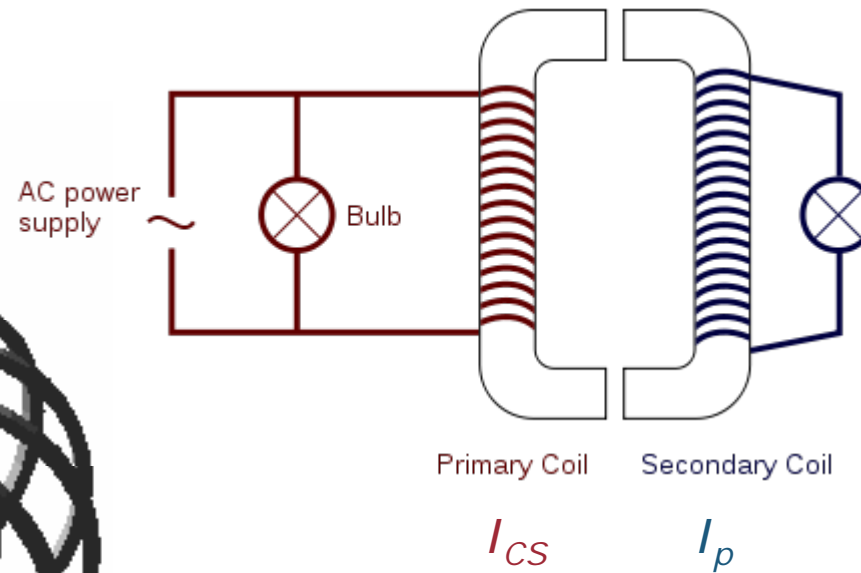
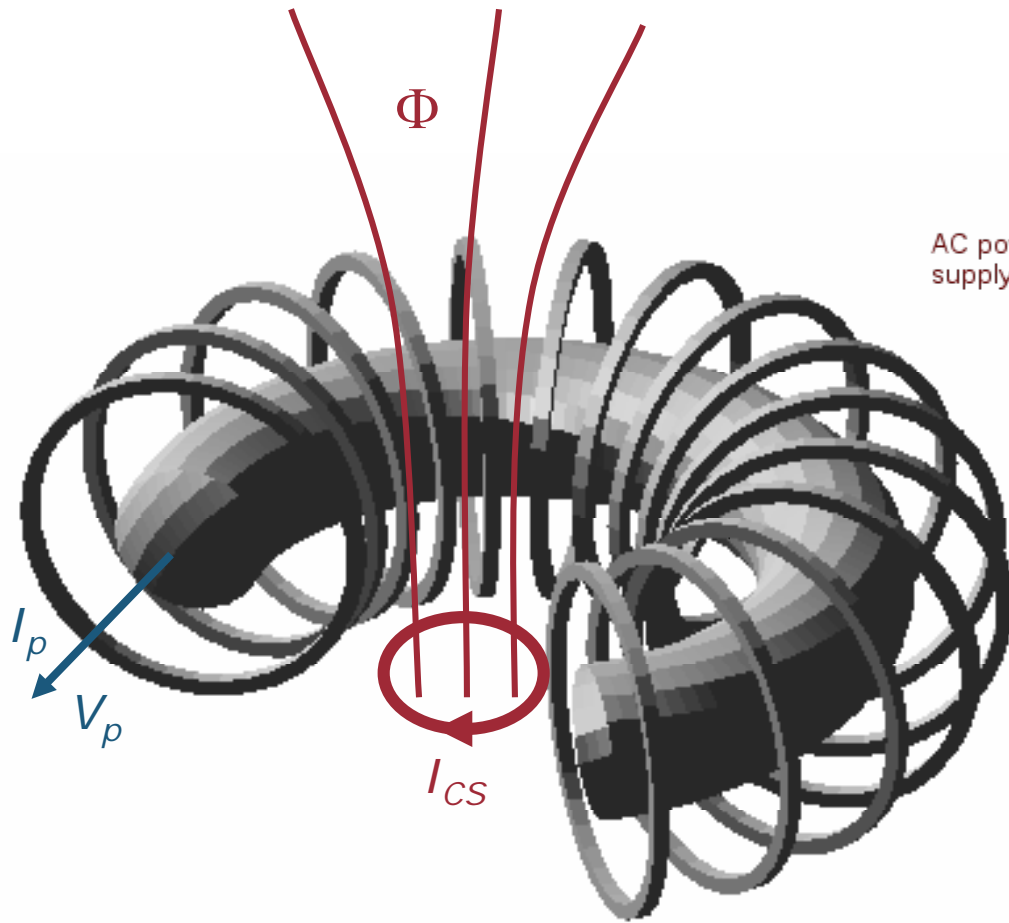

$$L_p \frac{dI_p}{dt} + I_p R_p = V_p = -\frac{d\phi}{dt}$$

Ohmic Heating

$$P_{\Omega} = \eta \langle j^2 \rangle = 1.0 \times 10^5 \left(\frac{Z_{eff}}{T^{3/2}} \right) \left[\frac{1}{q_o (q_a - q_o / 2)} \right] \left(\frac{B_{\phi}}{R} \right)^2$$

- Z_{eff} limited by radiation losses
- High T required for enough fusion reactions

q_o, q_a limited by instabilities

Magnetic field limited by engineering
→ compact high-field tokamak

Ohmic Heating

$$\tau_E = \frac{W}{P_{in} - \frac{\partial W}{\partial t}} \approx \frac{W}{P_{in}} = \frac{3/2(n_i T_i + n_e T_e)}{P_{in}}$$

$$P_{\Omega} = \eta \langle j^2 \rangle = 1.0 \times 10^5 \left(\frac{Z_{eff}}{T^{3/2}} \right) \left[\frac{1}{q_o (q_a - q_o / 2)} \right] \left(\frac{B_{\phi}}{R} \right)^2$$

$$= P_L = 3nT / \tau_E$$

$$T = 2.7 \times 10^8 \left(\frac{Z_{eff} \tau_E}{n q_a q_o} \right)^{\frac{2}{5}} \left(\frac{B_{\phi}}{R} \right)^{\frac{4}{5}}$$

$$Z_{eff} = 1.5 \quad q_a q_o = 1.5$$

$$\tau_E = (n / 10^{20}) a^2 / 2$$

Alcator scaling

$$T = 0.87 B_{\phi}^{\frac{4}{5}}$$

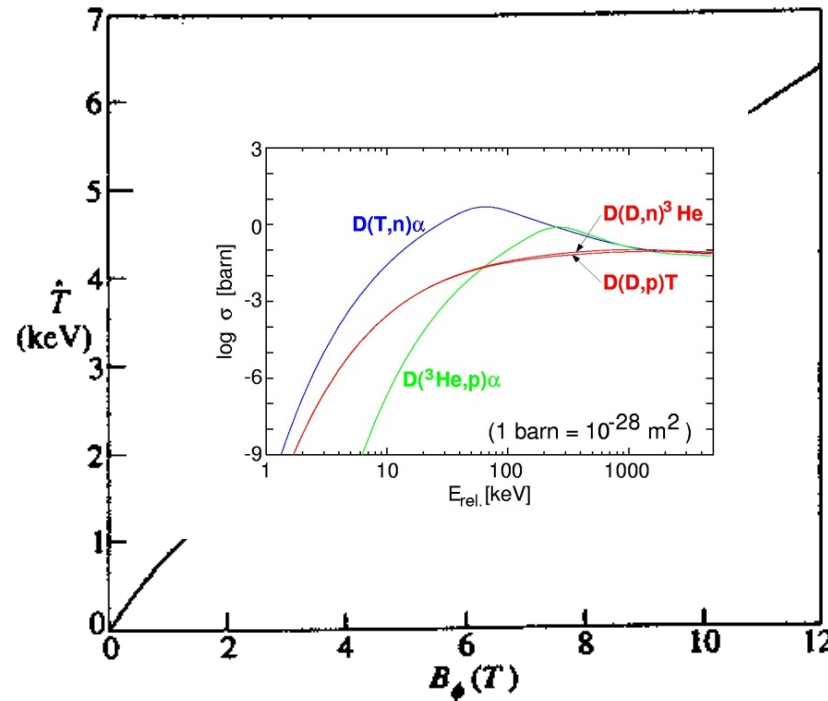

Average temperatures above ~ 7 keV are necessary before alpha heating is large enough to achieve a significant fusion rate.

Ohmic Heating

$$\tau_E = \frac{W}{P_{in} - \frac{\partial W}{\partial t}} \approx \frac{W}{P_{in}} = \frac{3/2(n_i T_i + n_e T_e)}{P_{in}}$$

$$P_{\Omega} = \eta \langle j^2 \rangle = 1.0 \times 10^5 \left(\frac{Z_{eff}}{T^{3/2}} \right) \left[\frac{1}{q_o (q_a - q_o / 2)} \right] \left(\frac{B_{\phi}}{R} \right)^2$$

$$= P_L = 3nT / \tau_E$$

$$T = 2.7 \times 10^8 \left(\frac{Z_{eff} \tau_E}{n q_a q_o} \right)^{\frac{2}{5}} \left(\frac{B_{\phi}}{R} \right)^{\frac{4}{5}}$$

$$Z_{eff} = 1.5 \quad q_a q_o = 1.5$$

$$\tau_E = (n / 10^{20}) a^2 / 2$$

Alcator scaling

$$T = 0.87 B_{\phi}^{\frac{4}{5}}$$

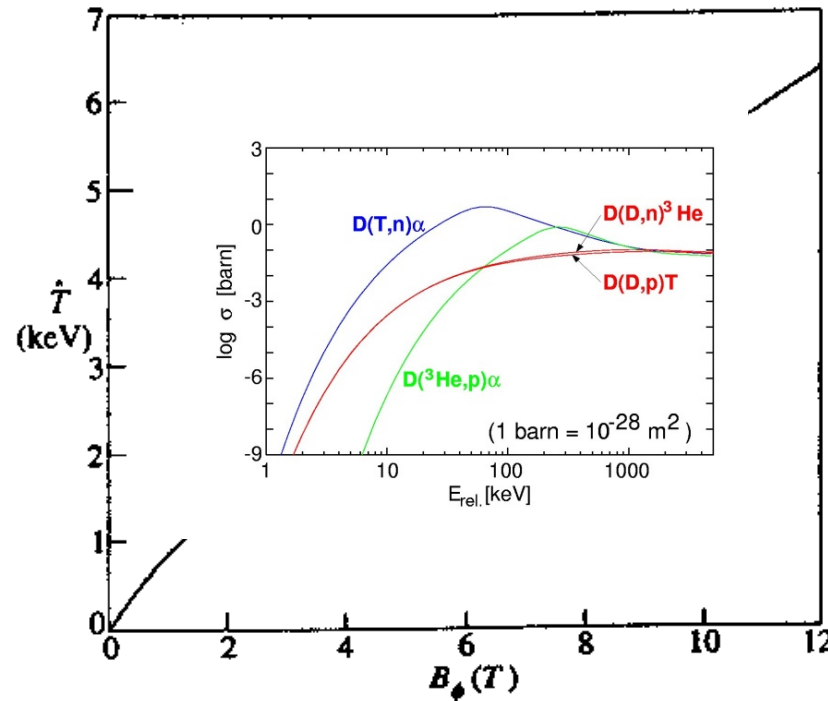

It seems unlikely that tokamaks that would lead to practical reactors can be heated to thermonuclear temperatures by Ohmic heating!

Neutral Beam Injection (NBI)

Neutral Beam Injection



259-Car Autobahn pile-up
near Braunschweig,
largest in German history:
(20 July 2009)

- More than 300 ambulances, fire engines and police cars rushed to the scene to tend to the 66 people injured in the crash.
- The crash was blamed on cars aquaplaning on puddles and a low sun hindering drivers.



Neutral Beam Injection



259-Car Autobahn pile-up near Braunschweig, largest in German history: (20 July 2009)

- More than 300 ambulances, fire engines and police cars rushed to the scene to tend to the 66 people injured in the crash.
- The crash was blamed on cars aquaplaning on puddles and a low sun hindering drivers.



Neutral Beam Injection



Neutral Beam Injection

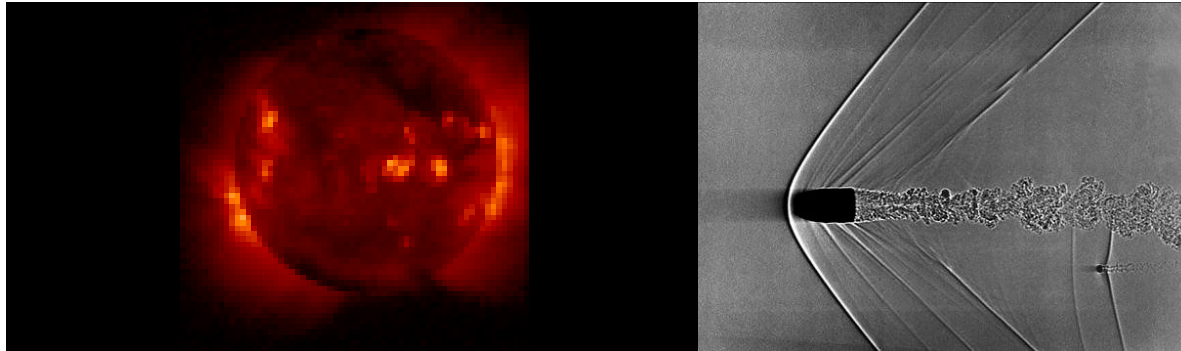

Plasma

Neutral beam

NBI



Andy Warhol

- Supplemental heating by energy transfer of neutral beam to the plasma through collisions
- Requirements
 - Enough energy for deep penetration
 - Enough power for desired heating
 - Enough repetition rate and pulse length $> T_E$

Neutral Beam Injection

Injection of a beam of neutral fuel atoms (H, D, T) at high energies*

⇓
Ionisation in the plasma

⇓
Beam particles confined

⇓
Collisional slowing down

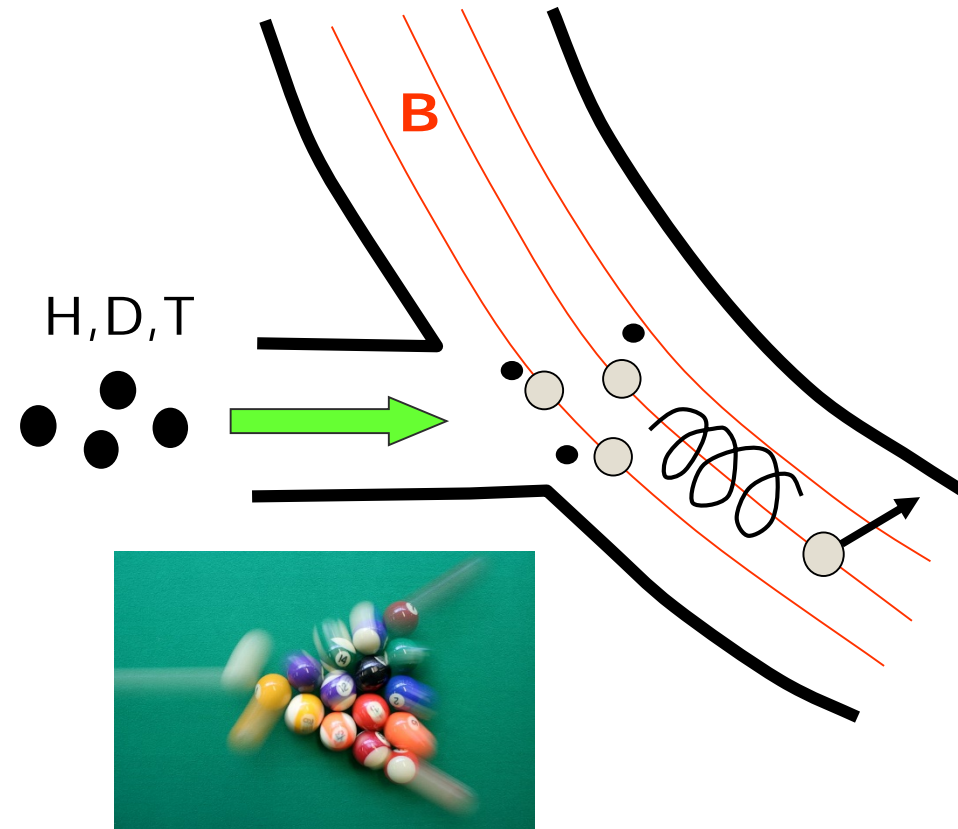

* $E_b = 120$ keV and 1 MeV for KSTAR and ITER, respectively

Neutral Beam Injection

- Neutraliser

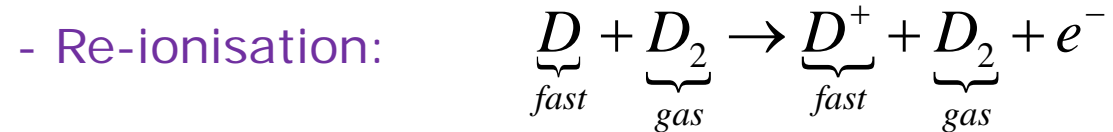

- Efficiency: (outgoing NB power)/(entering ion beam power)

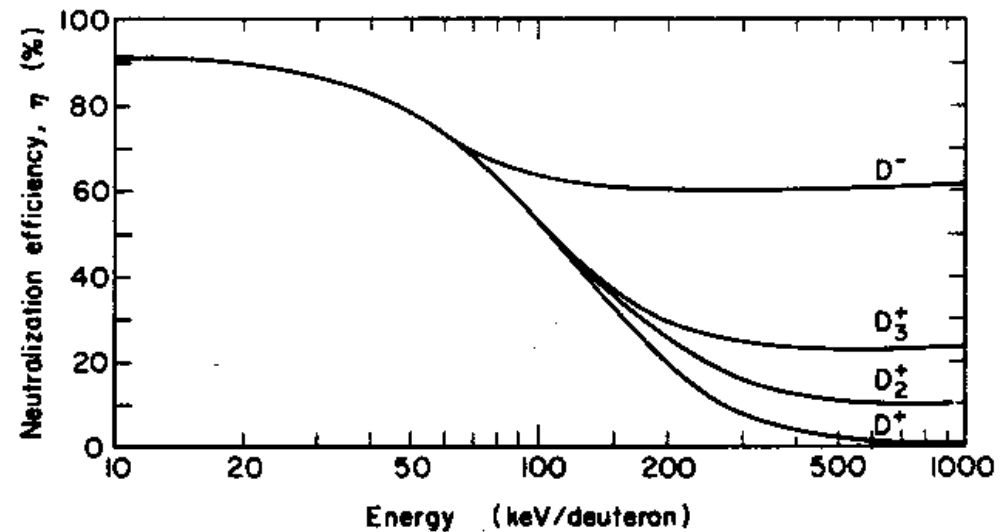

Neutral Beam Injection

- Energy Deposition in a Plasma

Charge exchange: $D_{fast} + D^+ \rightarrow D_{fast}^+ + D$

Ion collision: $D_{fast} + D^+ \rightarrow D_{fast}^+ + D^+ + e$

Electron collision: $D_{fast} + e \rightarrow D_{fast}^+ + e + e$

Attenuation of a beam of neutral particles in a plasma



n : density
 σ : cross section

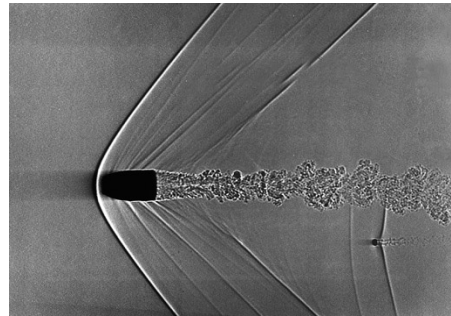

beam
energy



Andy Warhol

Neutral Beam Injection

• Energy Deposition in a Plasma

Charge exchange: $D_{fast} + D^+ \rightarrow D_{fast}^+ + D$

Ion collision: $D_{fast} + D^+ \rightarrow D_{fast}^+ + D^+ + e$

Electron collision: $D_{fast} + e \rightarrow D_{fast}^+ + e + e$

Attenuation of a beam of neutral particles in a plasma

$$\frac{dN_b(x)}{dx} = -N_b(x)n\sigma_{tot} \quad N_b(x) = N_b(0)\exp(-n\sigma_{tot}x)$$

Ex. beam intensity: $I(x) = N_b(x)v_b = I_0 \cdot \exp(-x/\lambda)$

$$\lambda = \frac{1}{n\sigma_{tot}} \approx 0.4m$$

Penetration
(attenuation) length

$$n = 5 \cdot 10^{20} m^{-3} \quad E_{b0} = 70keV \quad \sigma_{tot} = 5 \cdot 10^{-20} m^2$$

In large reactor plasmas, beam cannot reach core!

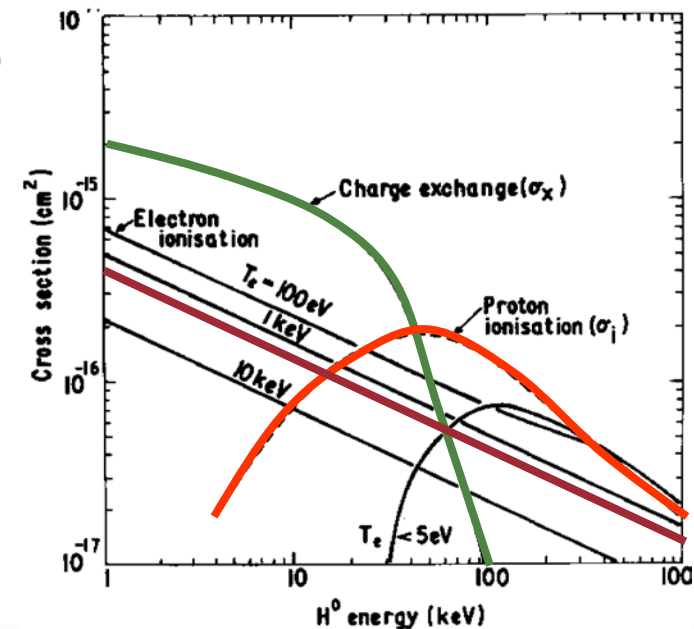

Neutral Beam Injection

- Energy Deposition in a Plasma

Charge exchange: $D_{fast} + D^+ \rightarrow D_{fast}^+ + D$

Ion collision: $D_{fast} + D^+ \rightarrow D_{fast}^+ + D^+ + e$

Electron collision: $D_{fast} + e \rightarrow D_{fast}^+ + e + e$

Attenuation of a beam of neutral particles in a plasma

General criterion for adequate penetration

$$\lambda \equiv \frac{1}{n\sigma_{tot}Z_{eff}^\gamma} = \frac{5.5 \times 10^{17} E_b (keV)}{A(amu)n(m^{-3})Z_{eff}^\gamma} \geq a/4$$

$$E_b \geq 4.5 \times 10^{-19} A n a Z_{eff}^\gamma$$

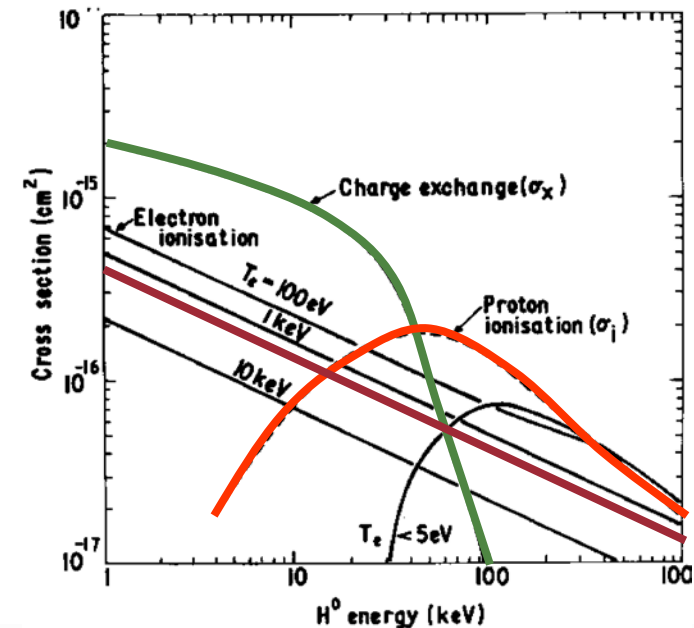

Neutral Beam Injection

- Energy Deposition in a Plasma

Charge exchange: $D_{fast} + D^+ \rightarrow D_{fast}^+ + D$

Ion collision: $D_{fast} + D^+ \rightarrow D_{fast}^+ + D^+ + e$

Electron collision: $D_{fast} + e \rightarrow D_{fast}^+ + e + e$

Attenuation of a beam of neutral particles in a plasma

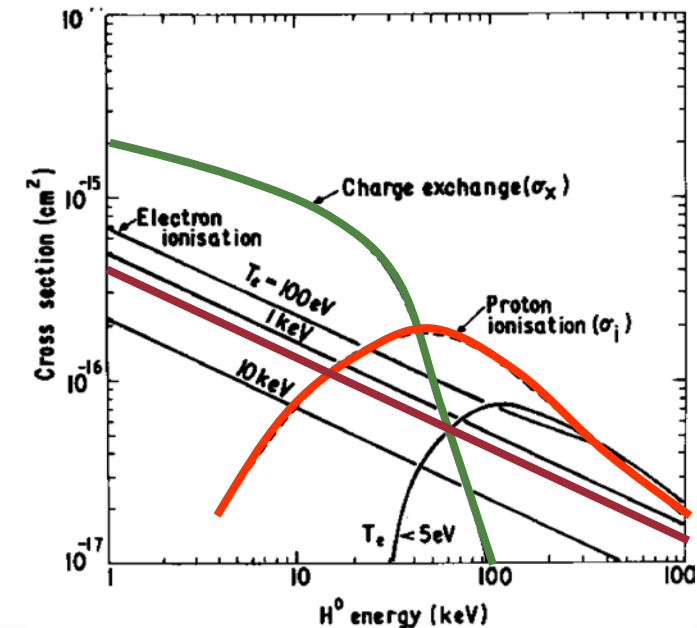
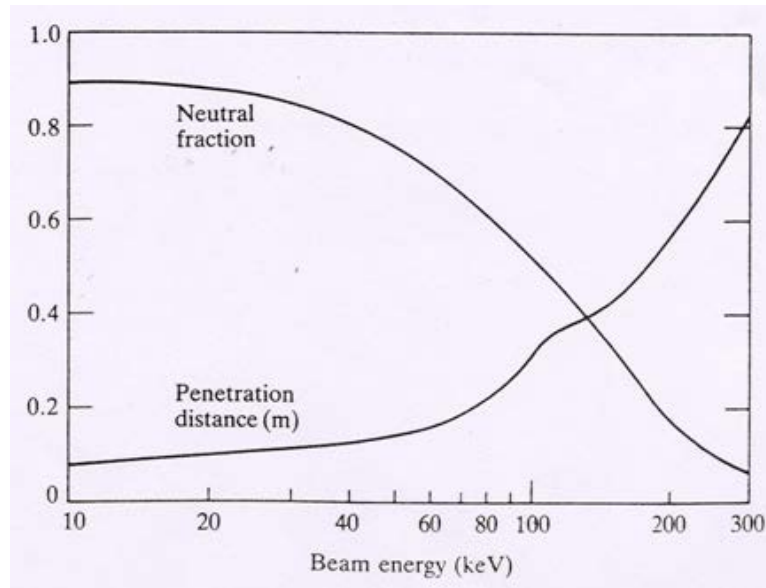

Neutral Beam Injection

- Energy Deposition in a Plasma

Charge exchange: $D_{fast} + D^+ \rightarrow D_{fast}^+ + D$

Ion collision: $D_{fast} + D^+ \rightarrow D_{fast}^+ + D^+ + e$

Electron collision: $D_{fast} + e \rightarrow D_{fast}^+ + e + e$

Attenuation of a beam of neutral particles in a plasma

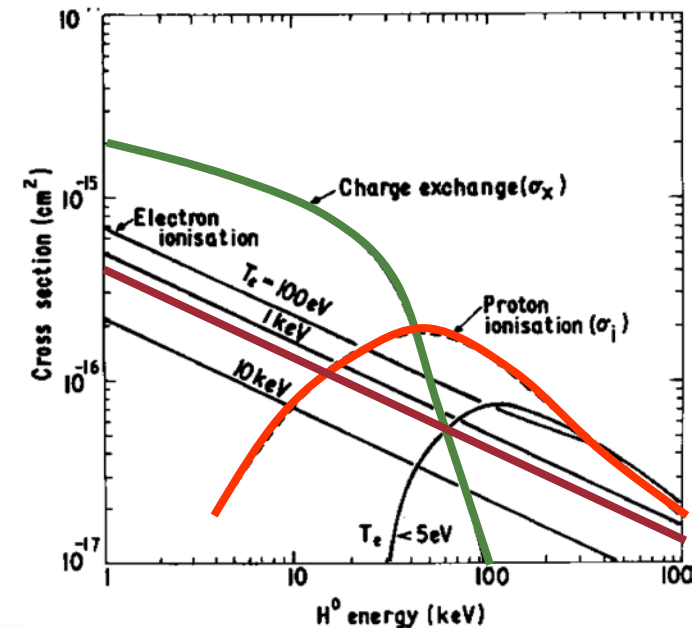
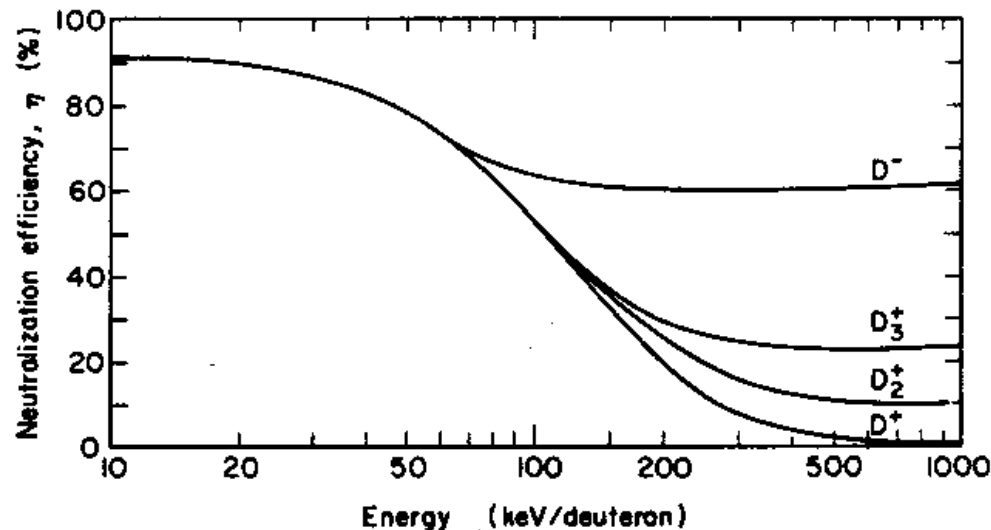

Neutral Beam Injection

- Generation of a Neutral Fuel Beam

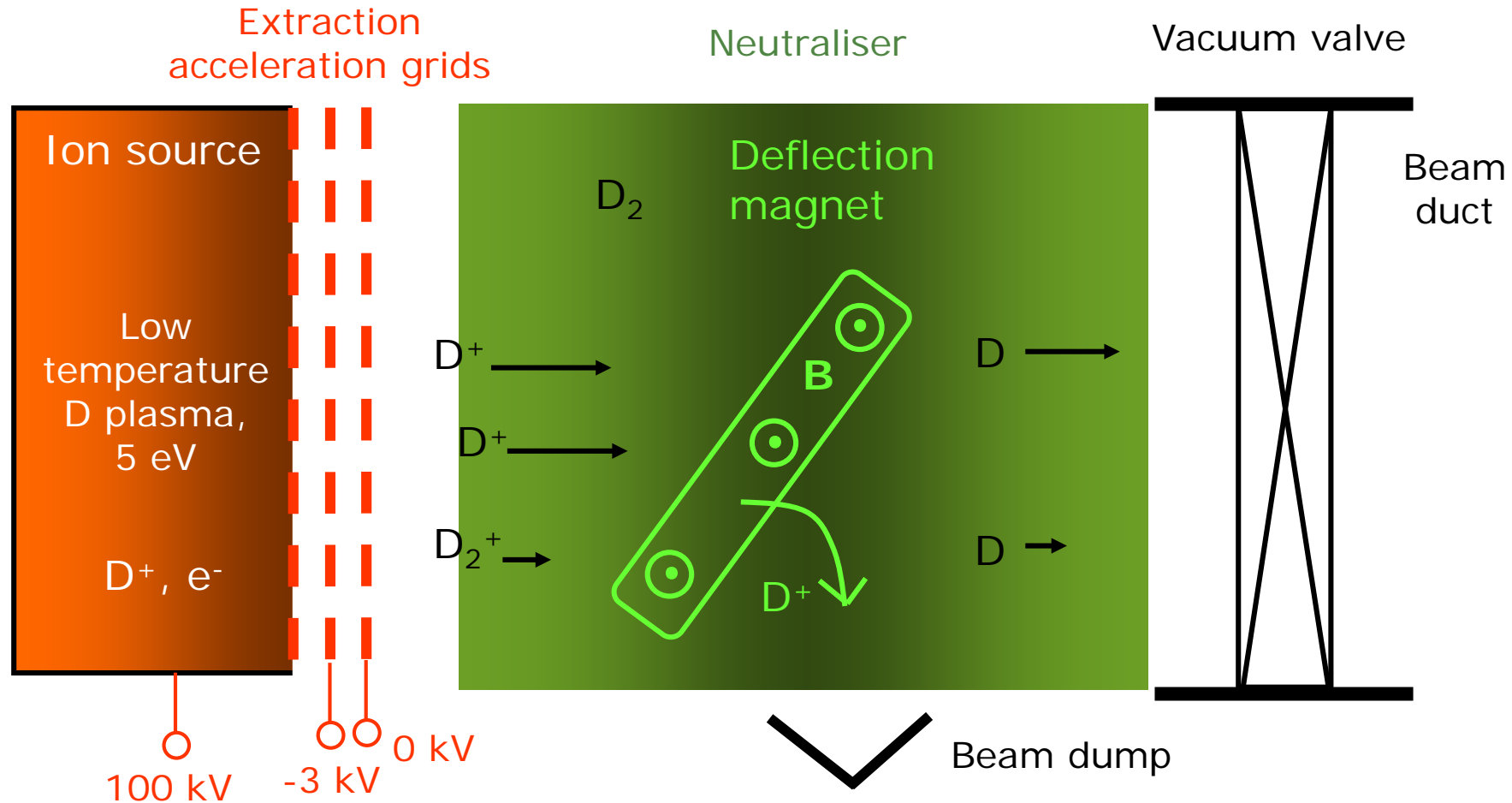

Ex) W7-AS: $V = 50 \text{ kV}$, $I = 25 \text{ A}$, power deposited in plasma: 0.4 MW

Neutral Beam Injection

- Ion Source

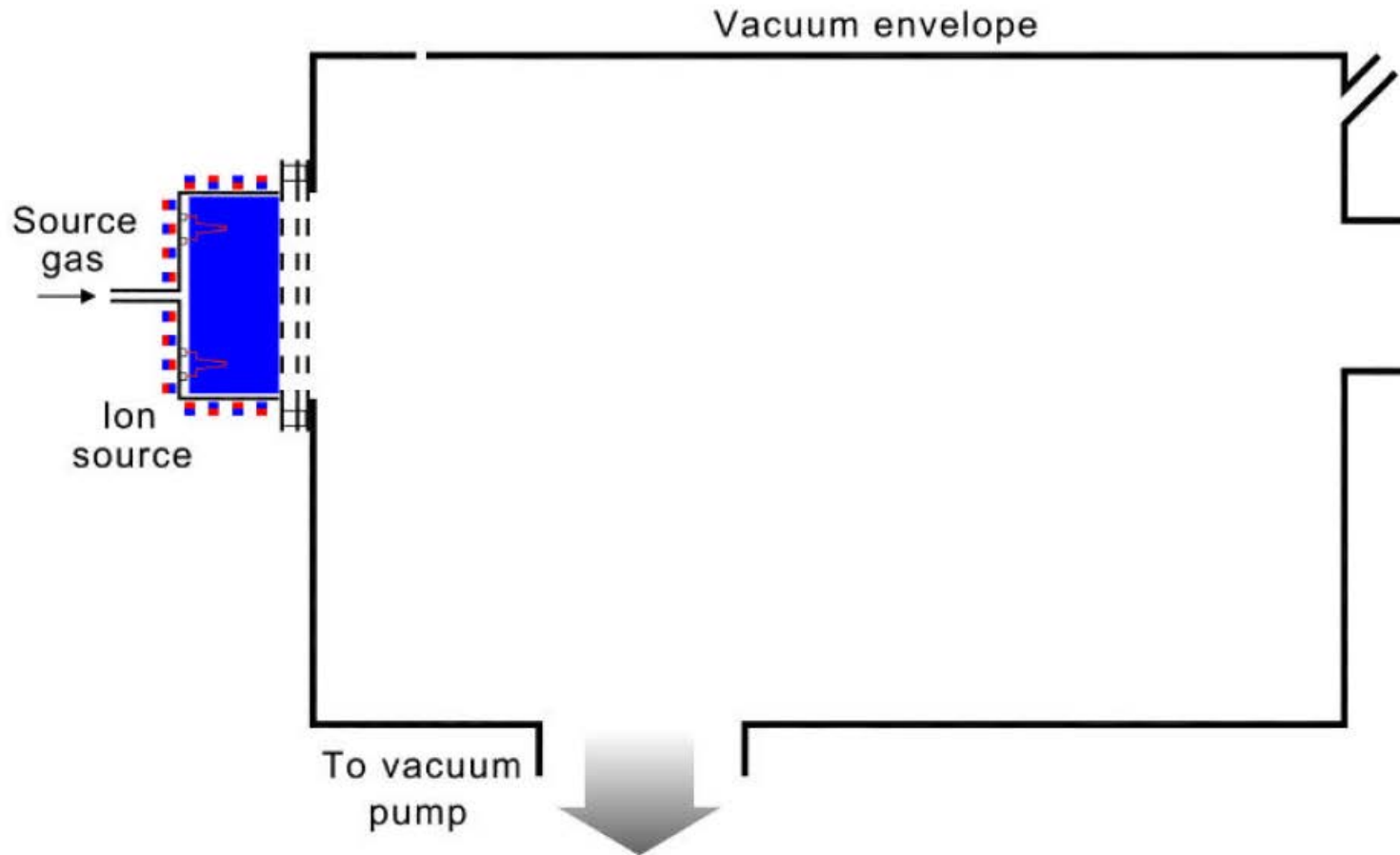

Neutral Beam Injection

- Ion Acceleration

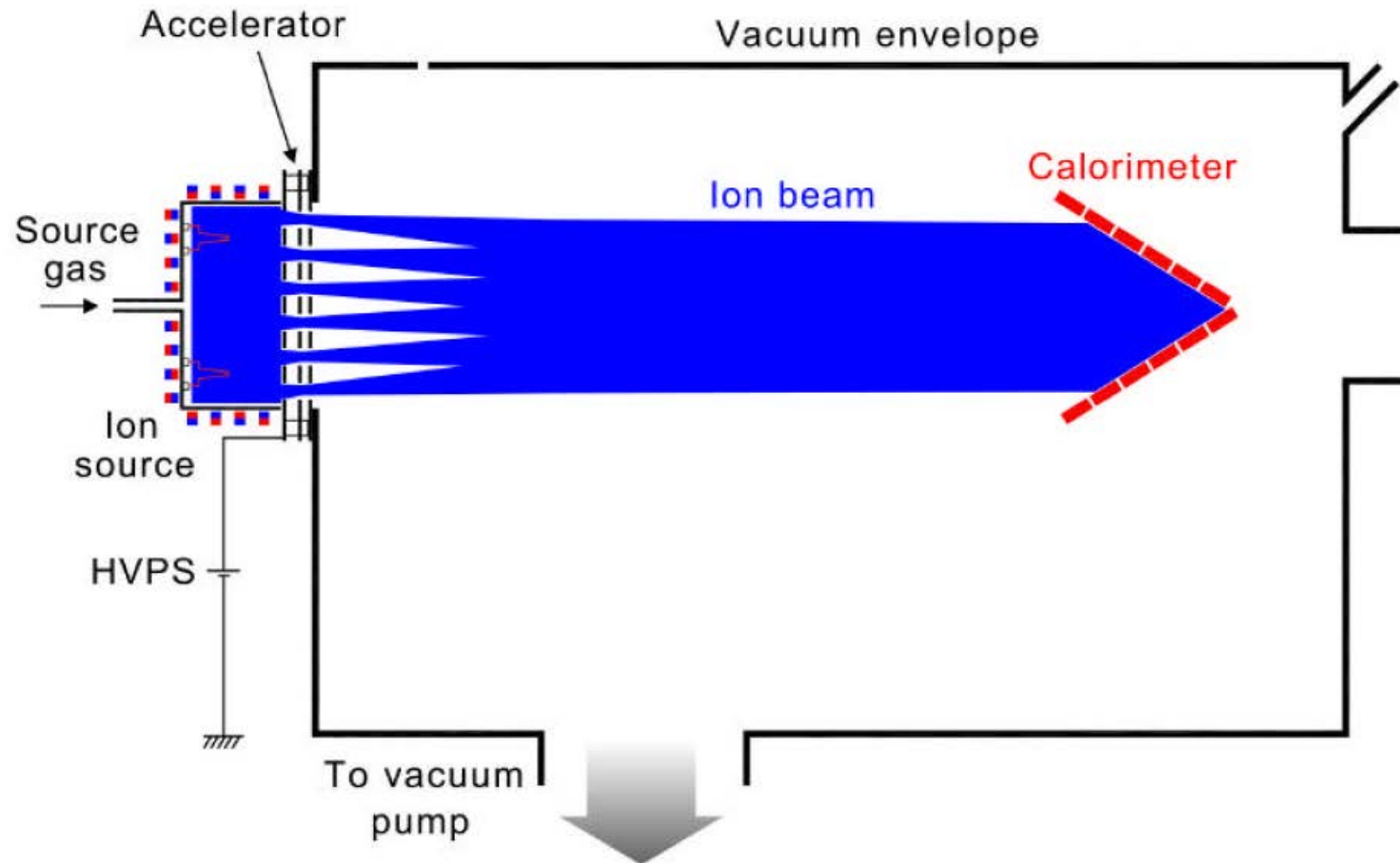

Neutral Beam Injection

- Ion Neutralisation

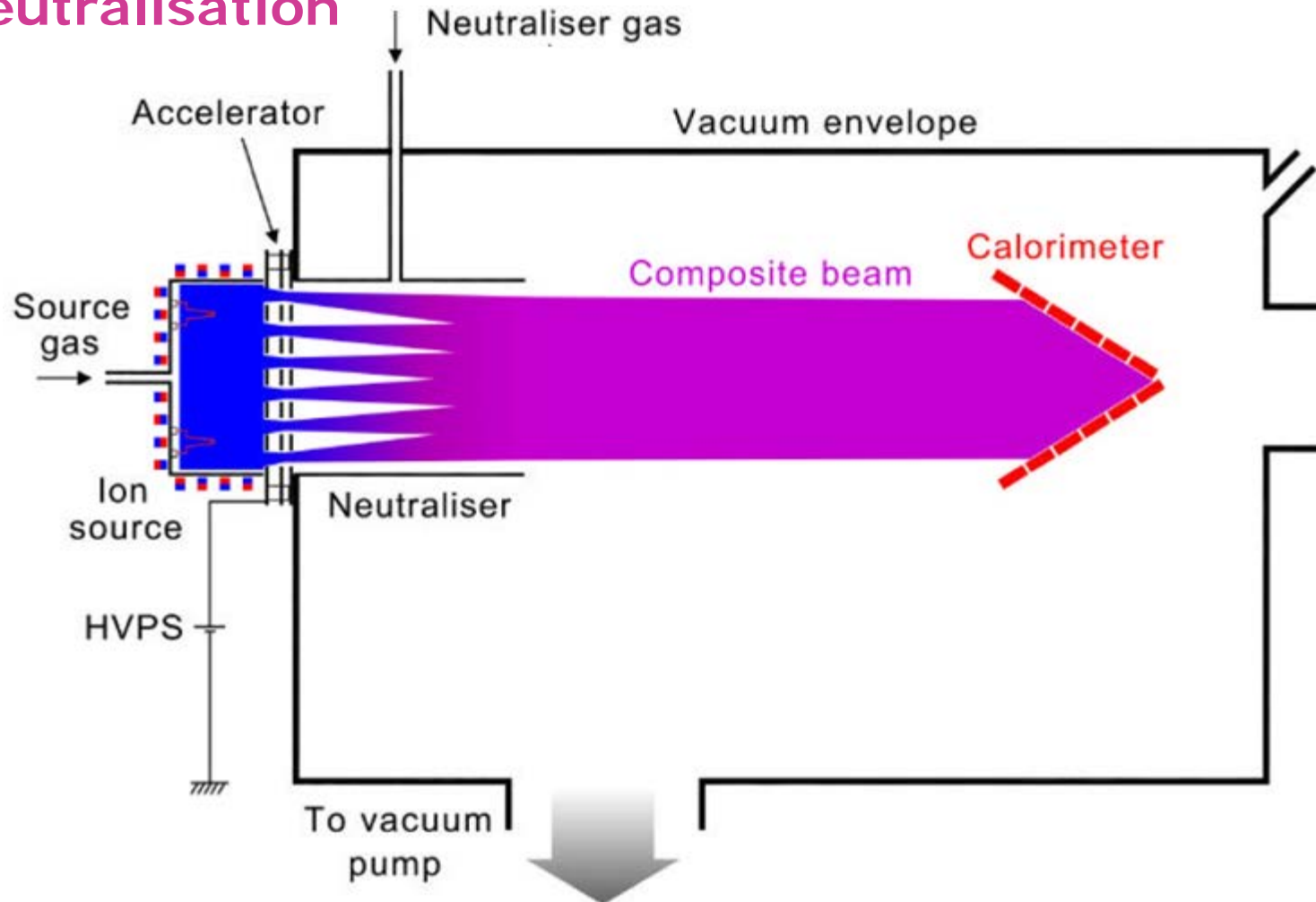

Neutral Beam Injection

- Ion Deflection

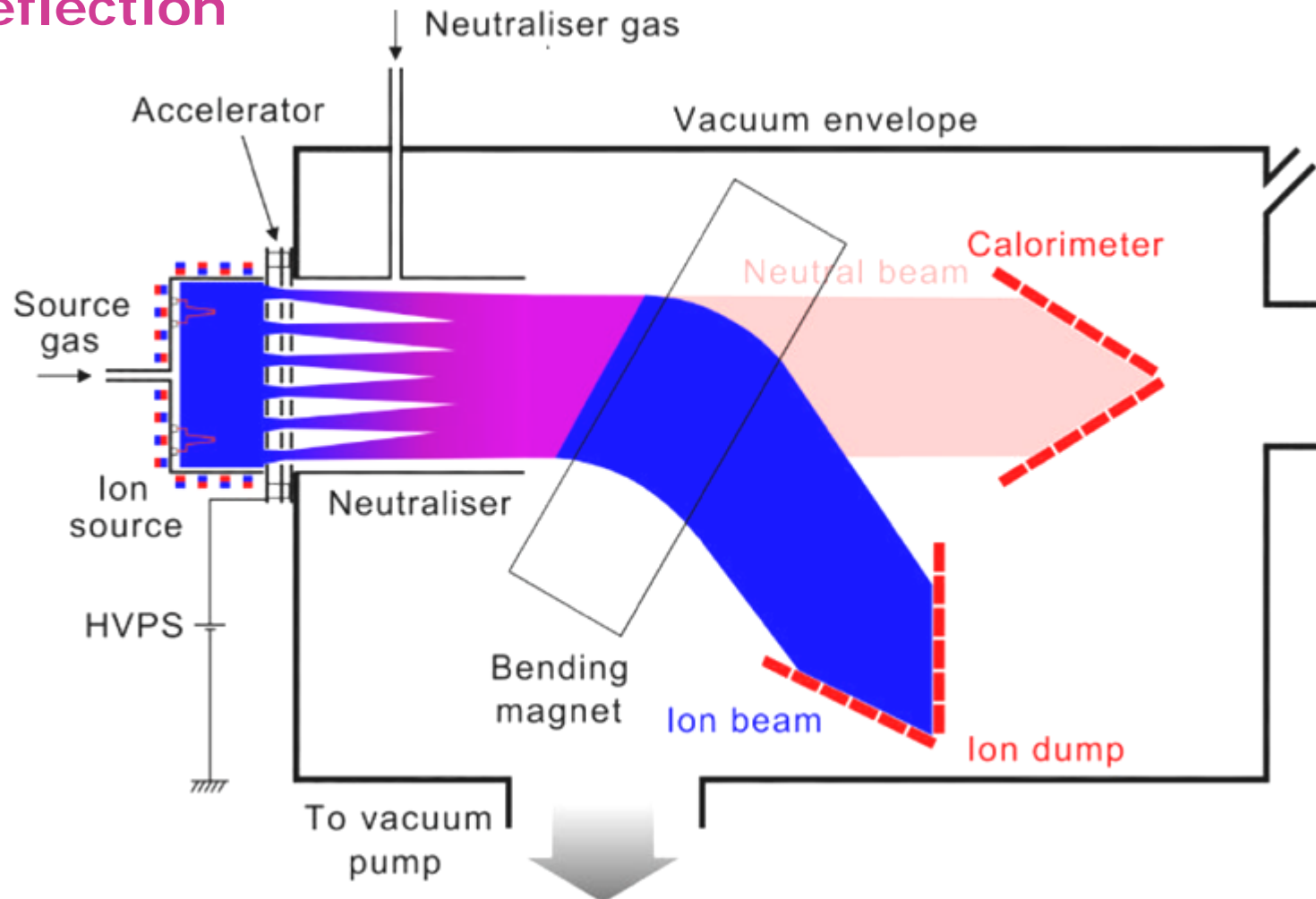

Neutral Beam Injection

- Neutral Injection

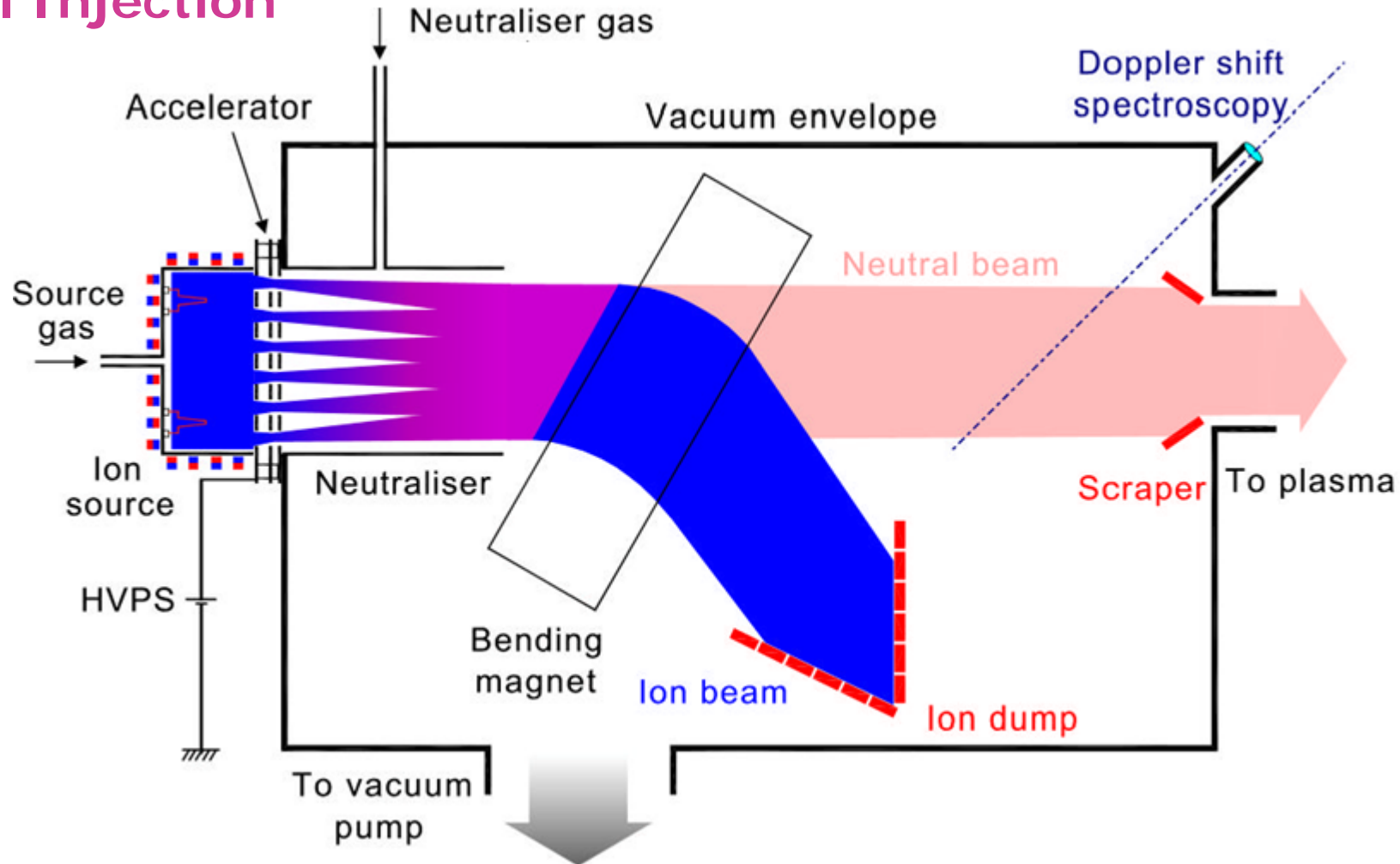

Neutral Beam Injection

- JET NBI System

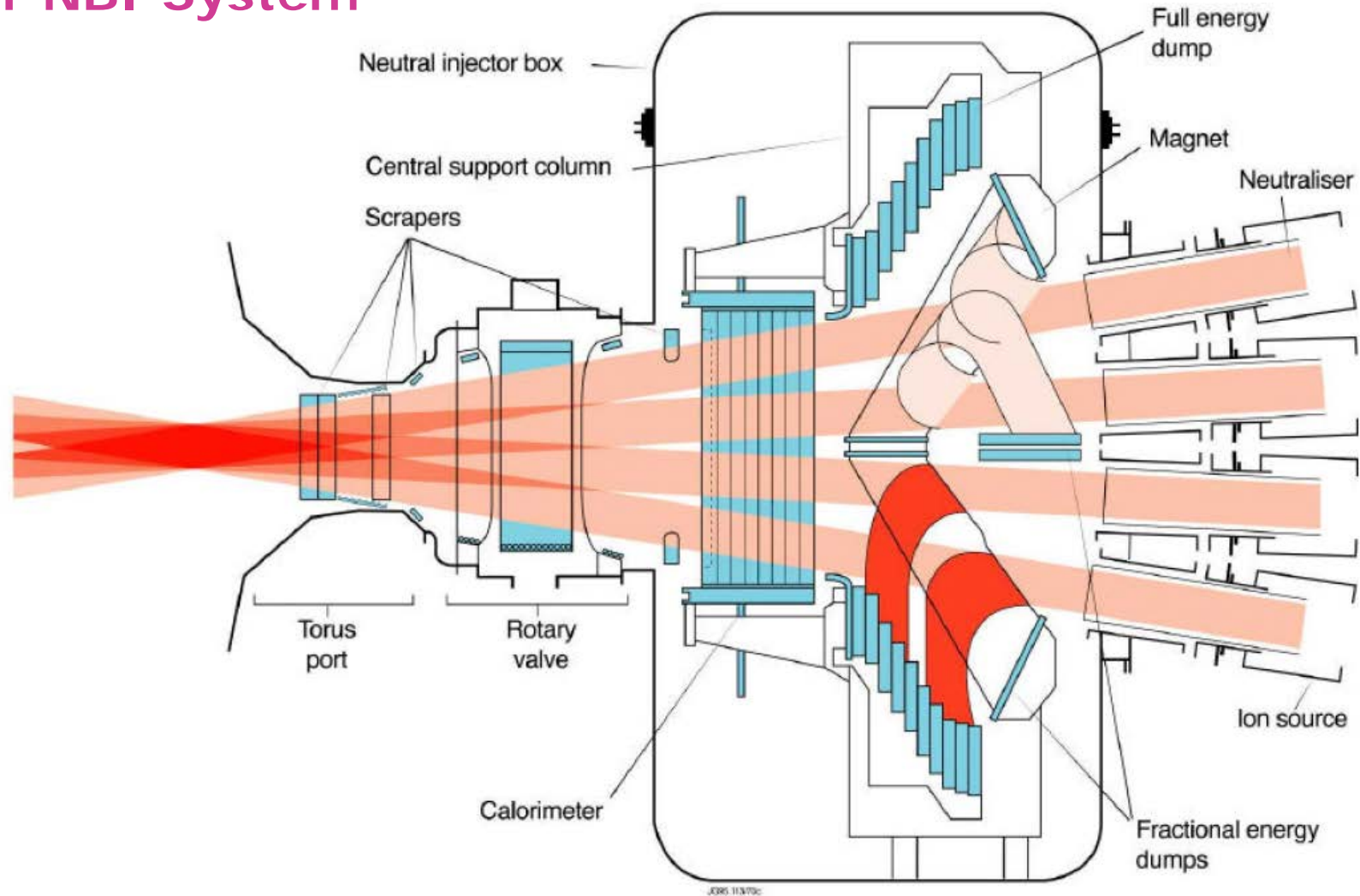

Neutral Beam Injection

- JET NBI System

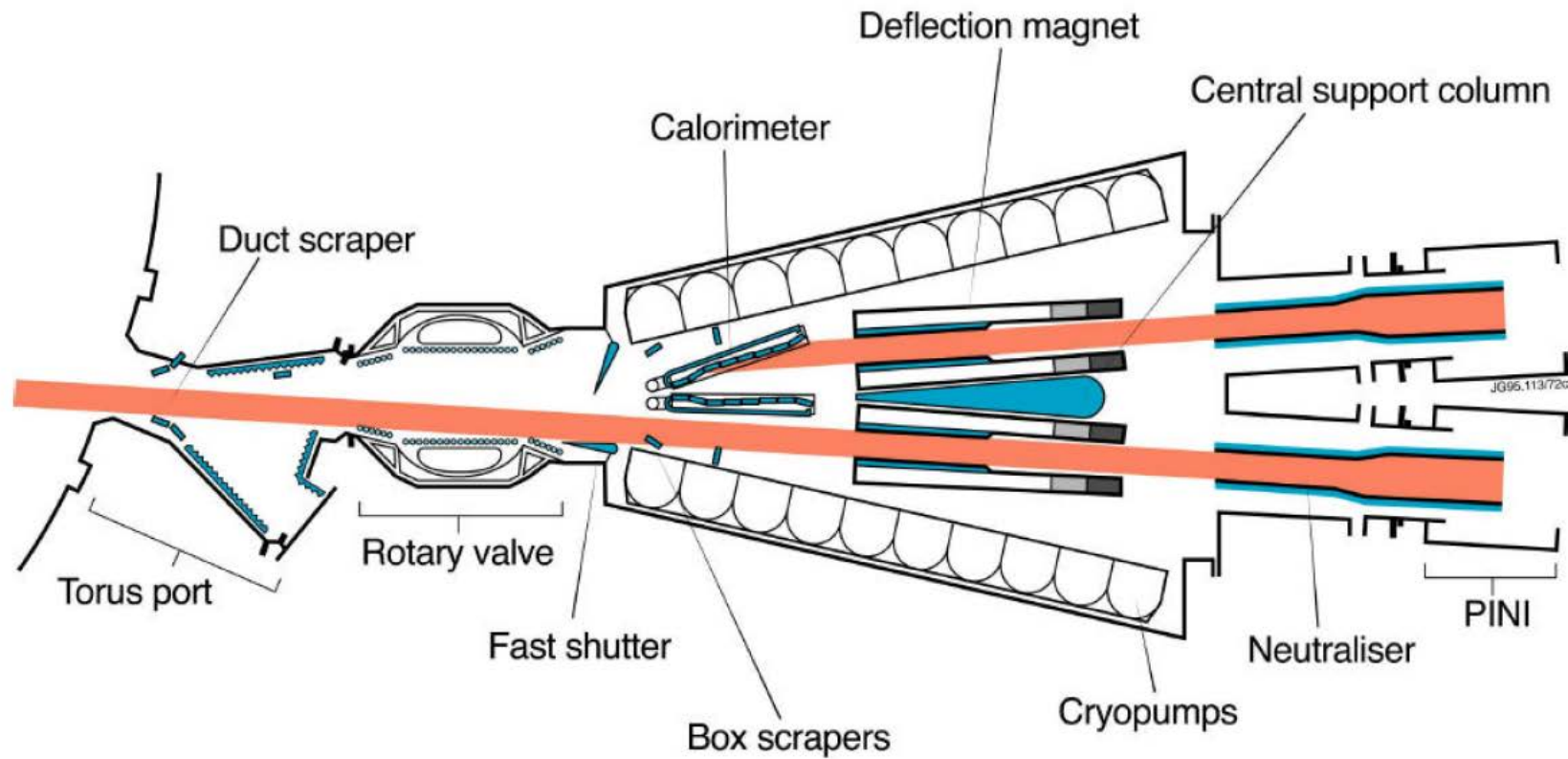

Neutral Beam Injection

- JET NBI System

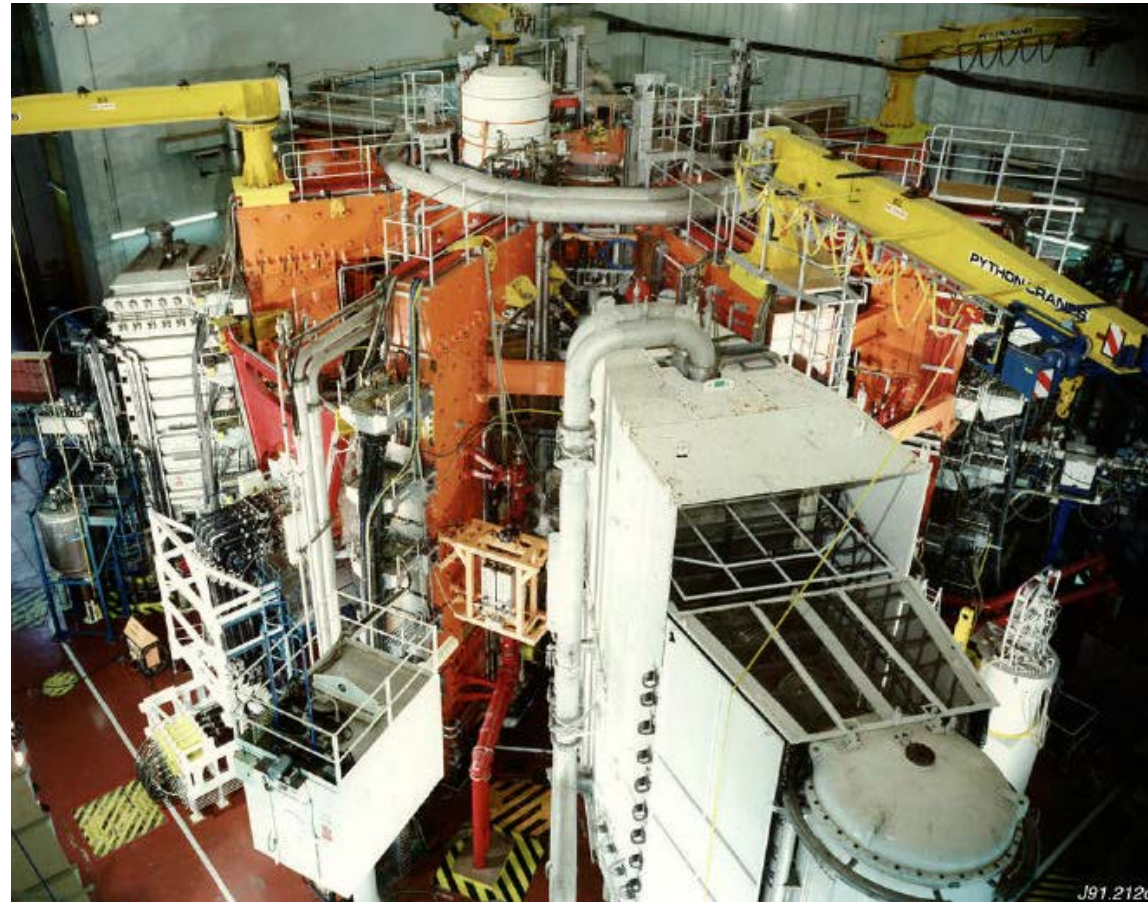

JET with machine and Octant 4 Neutral Injector Box

Neutral Beam Injection

- JET NBI System

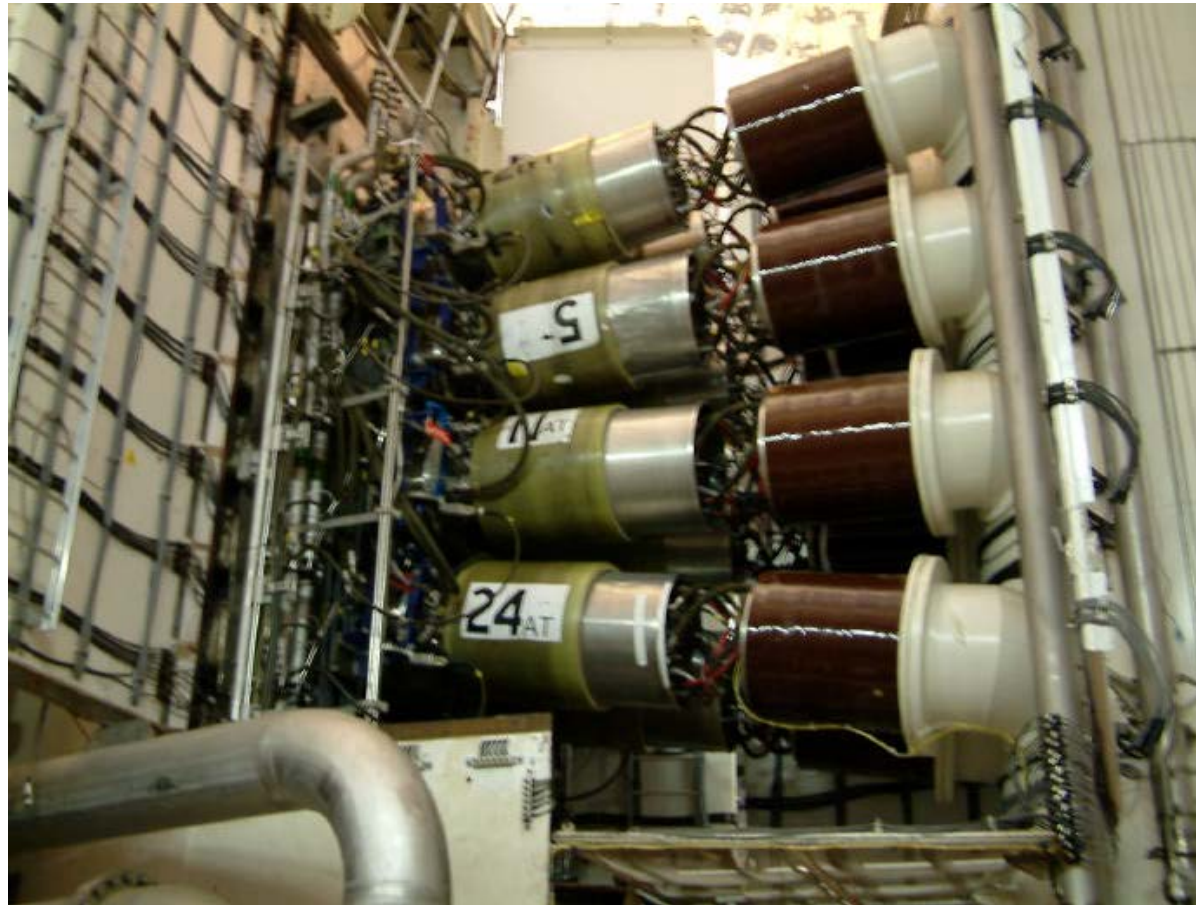

Octant 4 Neutral Injector Box

Neutral Beam Injection

- Injection Angle

Radial (perpendicular, normal) injection

Tangential injection

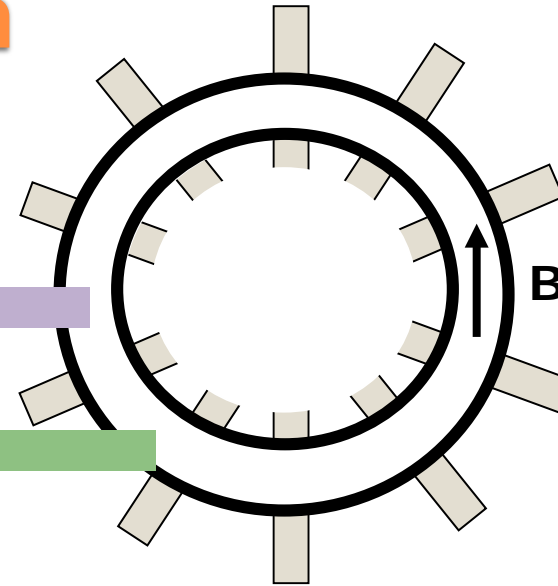

Radial injection:

- standard ports
- particle loss
- shine-through

$$\mathbf{v}_{D,\nabla B} = \pm \frac{1}{2} v_{\perp} r_L \frac{\mathbf{B} \times \nabla B}{B^2}$$

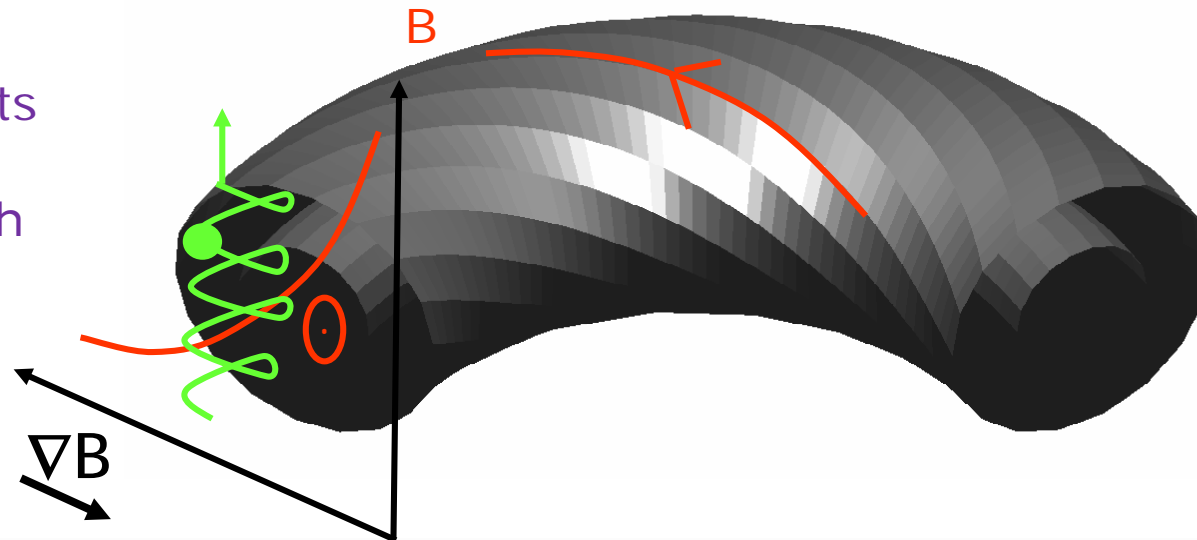

Neutral Beam Injection

- Injection Angle

Radial (perpendicular, normal) injection

Tangential injection

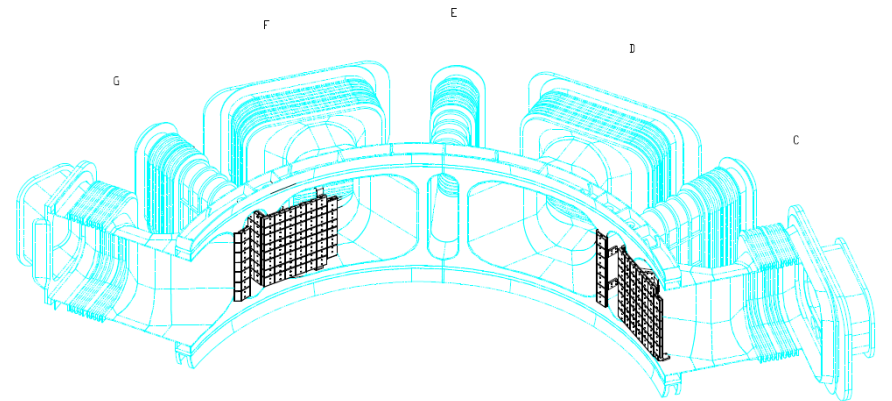
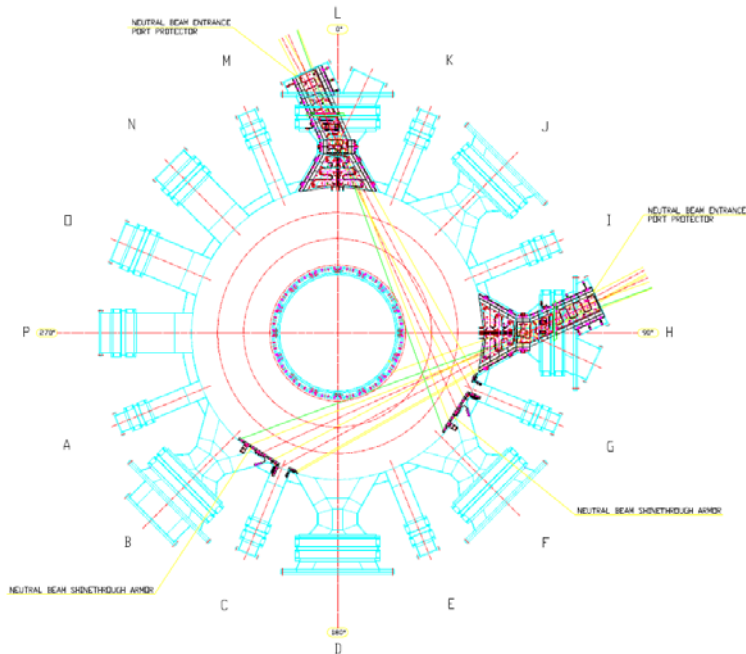
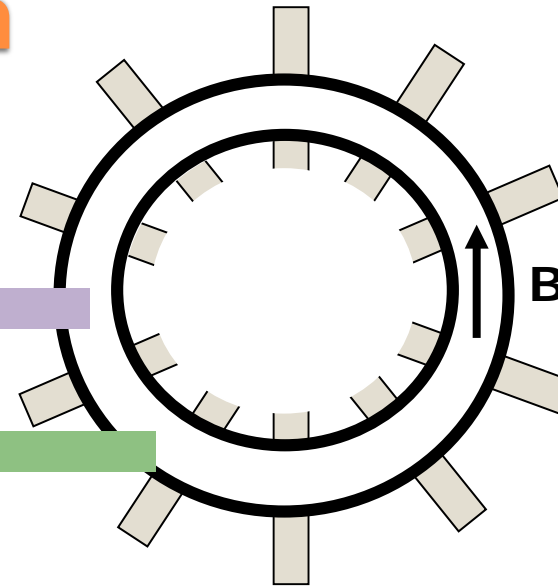

KSTAR NB shine-through armor

Neutral Beam Injection

ASDEX Upgrade

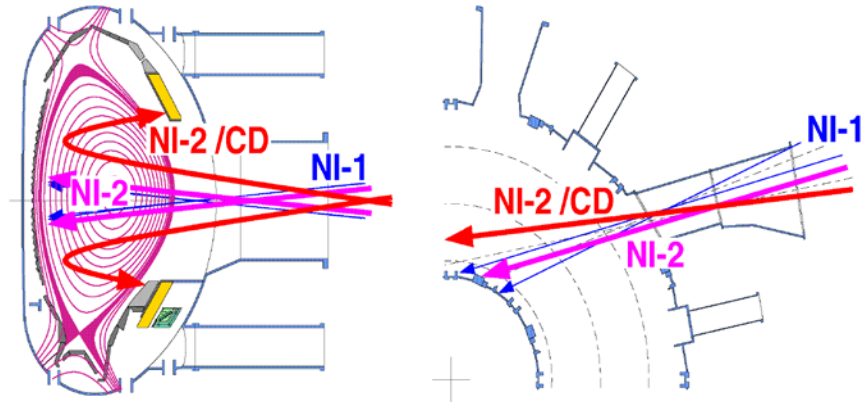

JET

