

Chap.1 FUNDAMENTALS

1.1 The Scope of Fluid Mechanics (Read text)

1.2 Historical Perspective (Read text)

1.3 Physical Characteristics of the Fluid State

	Solid	Fluid	
		Liquid	Gas
Spacing, Motion of molecules	Extremely Small	Small	Large
Intermolecular cohesive force	Large	Small	Extremely Small

Continuum assumption:

- No voids or holes in a fluid
- Valid in most engineering problems (except gas flow at very low pressure)

Solid

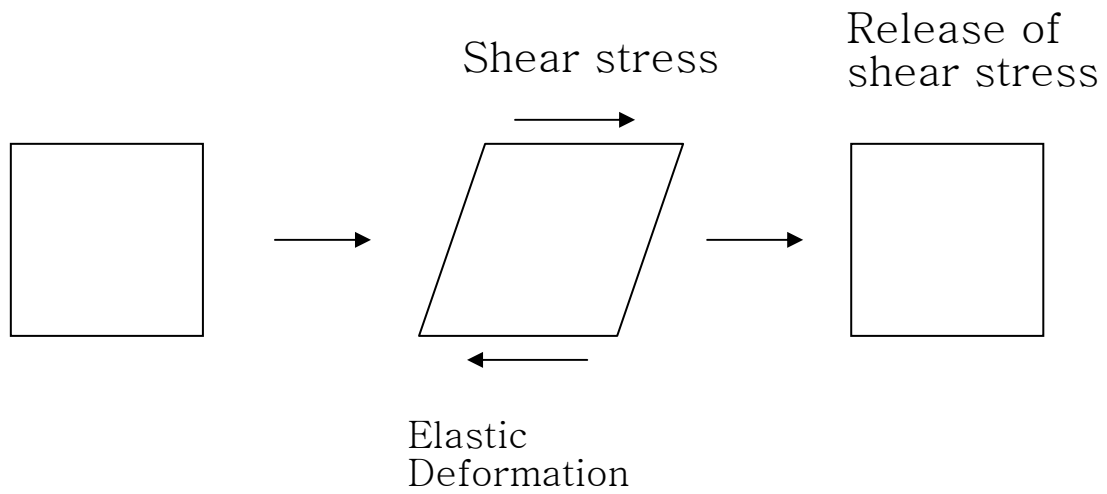

Fluid

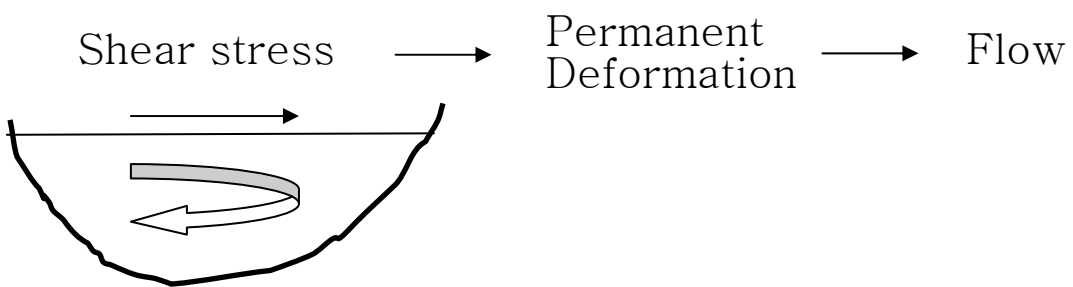

Fluid at rest \rightarrow No shear stress \rightarrow Pressure only
 (정지유체)

\downarrow
 Normal to a boundary
 (See Fig. 1.1)

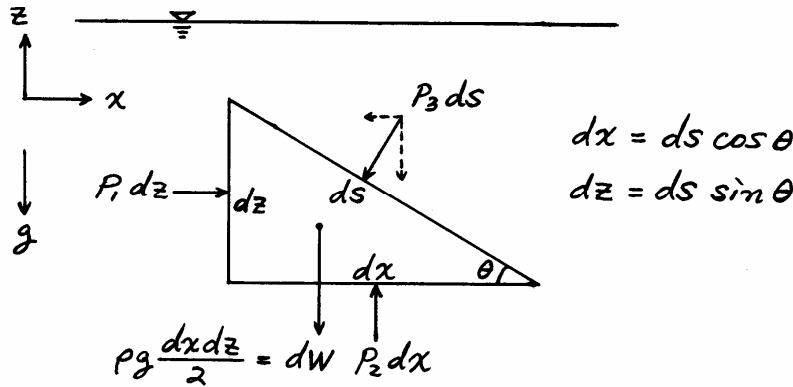

Newton's 2nd law: $\vec{F} = m\vec{a} = 0$ (\because 정지유체)

$$\sum F_x = p_1 dz - p_3 ds \sin \theta = 0$$

$$p_1 ds \sin \theta - p_3 ds \sin \theta = 0 \Rightarrow p_1 = p_3$$

$$\sum F_z = p_2 dx - p_3 ds \cos \theta - dW = 0$$

$$p_2 ds \cos \theta - p_3 ds \cos \theta - \frac{\rho g}{2} ds \cos \theta dz = 0$$

$$p_2 - p_3 - \frac{\rho g}{2} dz = 0$$

If $dx, dz \rightarrow 0$ (or at a point), $p_2 = p_3$

\therefore At a point, $p_1 = p_2 = p_3$

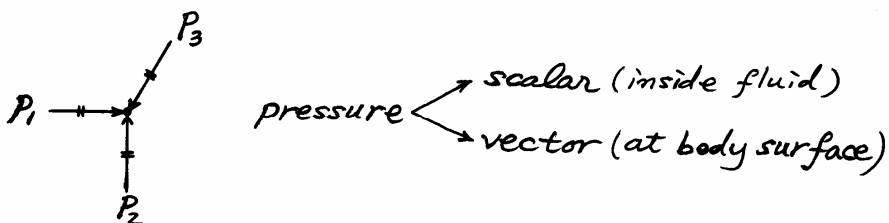

1.4 Units, Density, Specific Weight,
Specific Volume, and Specific Gravity

$$\rho \text{ (density)} = \frac{\text{mass}}{\text{unit volume}}$$

$$\gamma \text{ (specific weight)} = \rho g$$

$$\alpha \text{ (specific volume)} = \frac{\text{volume}}{\text{unit mass}} = \frac{1}{\rho}$$

$$\text{s.g. (specific gravity)} = \frac{\rho}{\rho_w}$$

See Appendix 1 for units and dimensions of various fluid quantities.

1.5 Compressibility, Elasticity

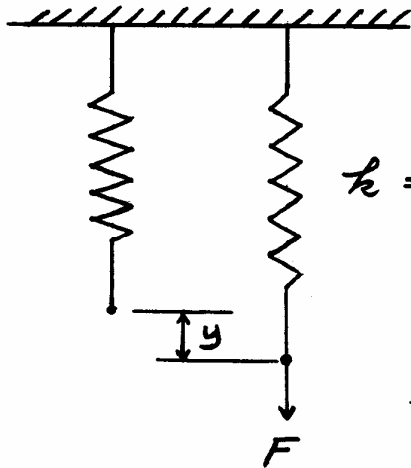

k = Young's modulus

$$y = \frac{F}{k}$$

$y \downarrow$ as $k \uparrow$ (stiffer)

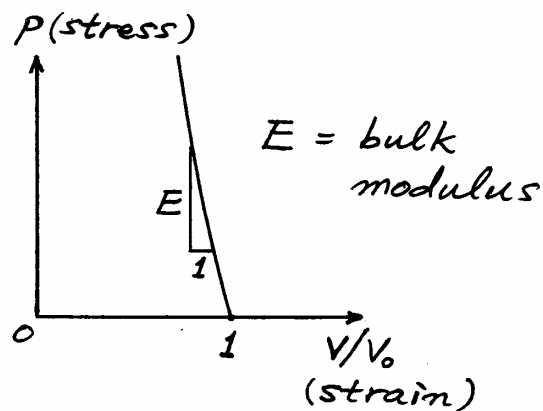
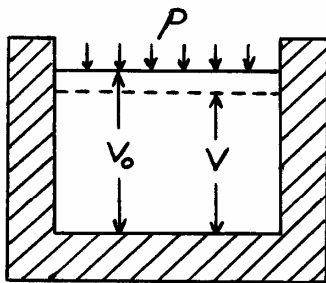

$$E = -\frac{dp}{d(V/V_0)}$$

$E = 2.07 \times 10^9 \text{ N/m}^2$ for water \rightarrow very large

\therefore Water is incompressible fluid.

1.6 Viscosity (粘性)

- Laminar flow (層流)

- 완만하고 규칙적인 흐름
- 유체 입자들이 층을 이루어 서로 미끄러지는 듯이 보임
- 흐름의 층 사이에 대규모 혼합이 없음

- Turbulent flow (亂流)

- 불규칙하고 무질서한 흐름
- 흐름 내에 대규모 혼합이 존재함
- 다양한 크기의 와(eddy)가 존재함

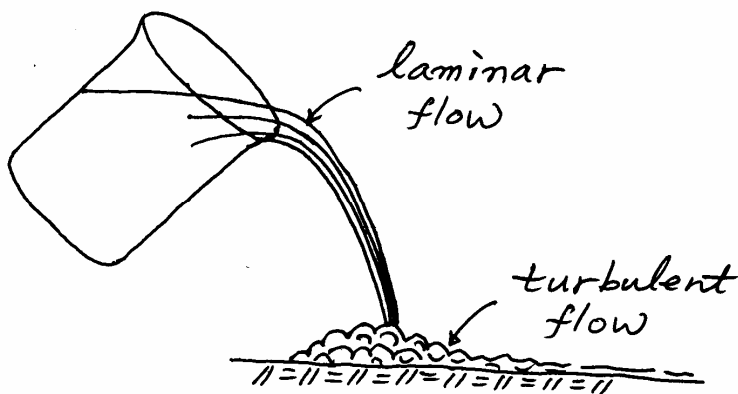

- Viscosity and shear stress in laminar flow

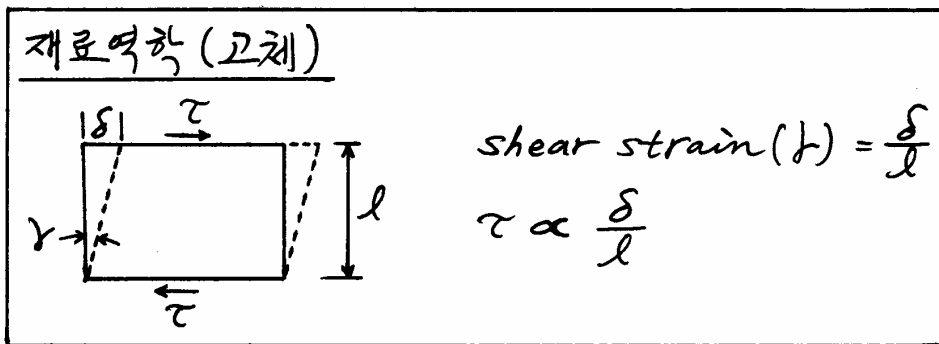
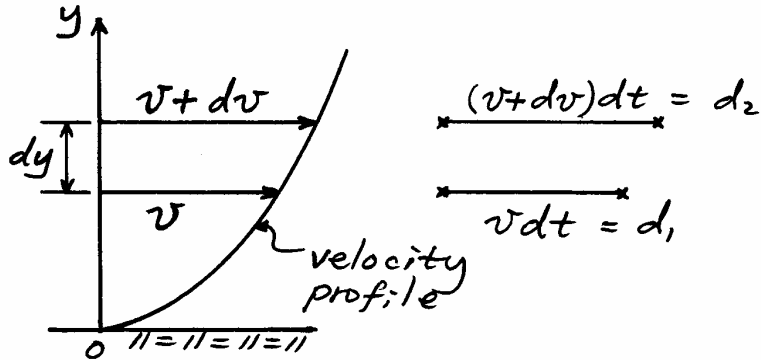

$$\text{(Shear) strain} = \frac{d_2 - d_1}{dy} = \frac{dvdt}{dy} = \frac{dv}{dy} dt$$

$$\text{Rate of strain} = \frac{\frac{dv}{dy} dt}{dt} = \frac{dv}{dy} = \text{vertical velocity gradient}$$

$$\text{Shear stress}(\tau) = \frac{\text{frictional force}}{\text{unit area}}$$

$$\text{For laminar flow, } \tau \propto \frac{dv}{dy} \text{ (observation)}$$

$$\tau = \mu \frac{dv}{dy} ; \mu = \text{coefficient of viscosity (점성계수)}$$

$$\nu = \frac{\mu}{\rho}$$

μ (dynamic viscosity) vs ν (kinematic viscosity)

Unit of $\mu = \text{Pa}\cdot\text{s}$ (힘의 단위 포함)

Unit of $\nu = \text{m}^2/\text{s}$ (운동의 단위의 조합)

Read text and IP1.9 for coaxial cylinders.

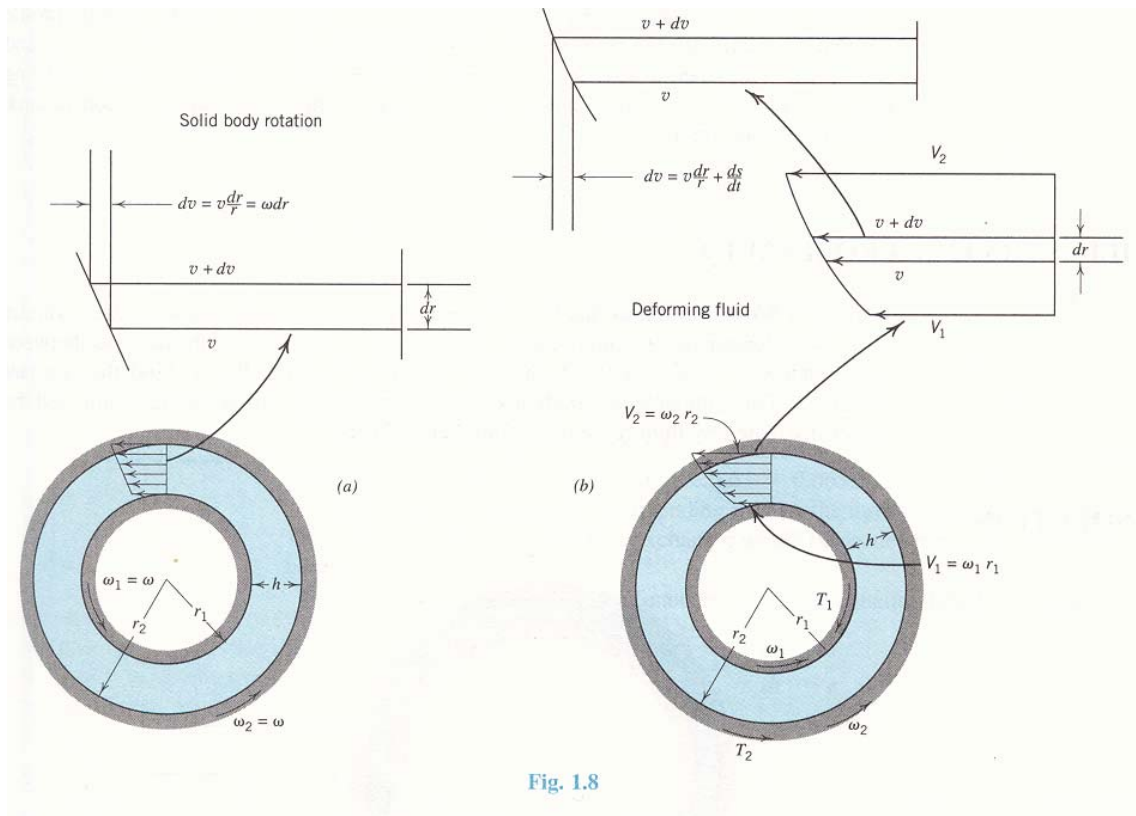

1.7 Surface Tension, Capillarity

cohesion (b/w fluid particles) }
 adhesion (b/w fluid and solid) } \rightarrow surface tension, σ
 (tangential to free surface)

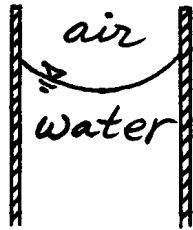

adhesion > cohesion

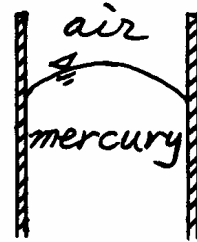

cohesion > adhesion

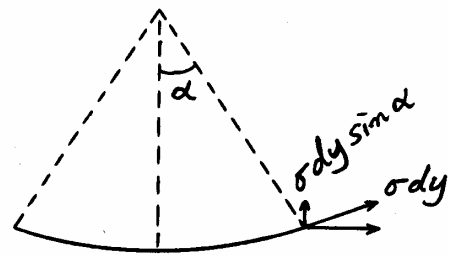
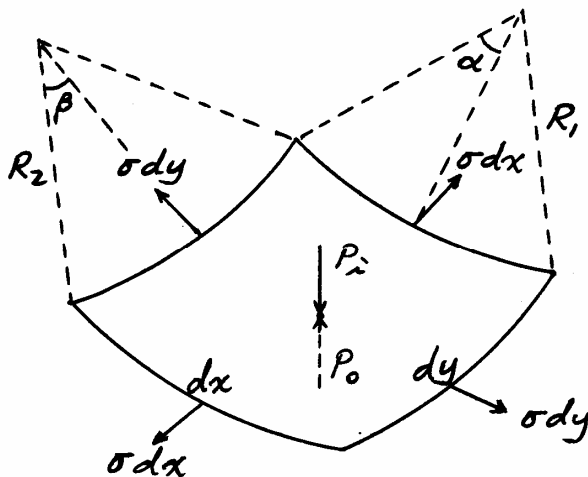

Balance of force \perp surface:

$$\sum F = (p_i - p_o) dx dy - 2\sigma dy \sin \alpha - 2\sigma dx \sin \beta = 0$$

$$\sin \alpha = \frac{dx/2}{R_1}, \quad \sin \beta = \frac{dy/2}{R_2}$$

$$p_i - p_o = \sigma \left(\frac{1}{R_1} + \frac{1}{R_2} \right)$$

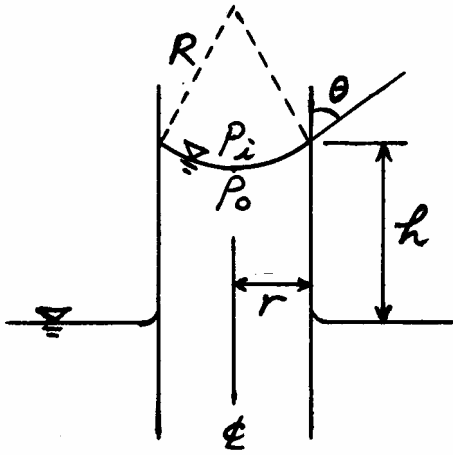

$$p_i - p_o = \sigma \left(\frac{1}{R_1} + \frac{1}{R_2} \right)$$

$$p_i = 0, \quad p_o = -\gamma h$$

$$R_1 = R_2 = R$$

$$\frac{r}{R} = \cos \theta$$

$$\gamma h = \sigma \left(\frac{\cos \theta}{r} + \frac{\cos \theta}{r} \right) = \frac{2\sigma \cos \theta}{r}$$

$$\therefore h = \frac{2\sigma \cos \theta}{\gamma r}$$

1.8 Vapor Pressure (蒸氣壓)

- Boiling: 유체 전반에 걸쳐 공기방울들이 형성되는 현상
- Boiling point(沸騰點) = f (external pressure)

Ex: Water boils at 100°C at sea level

 " " at 60°C at 12 km above
 sea level (low atmospheric pressure)

- Vapor pressure (p_v) = a pressure below which boiling occurs

$p_v = f(\text{temperature})$: Table A2.4b

- $p < p_v \rightarrow$ Boiling \rightarrow Cavitation

\rightarrow 주변 물체의 부식,
효율의 감소,
진동 문제 등

