

2009 fall

Phase Transformation of Materials

12. 10. 2009

Eun Soo Park

Office: 33-316

Telephone: 880-7221

Email: espark@snu.ac.kr

Office hours: by an appointment

Contents for previous class

- **Spinodal Decomposition: no barrier to nucleation**

- **Particle Coarsening**

~ 고온재료의 기계적 특성과 밀접한 관계

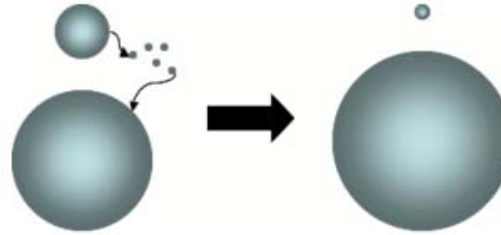

(Ostwald Ripening)

- **Precipitation of Ferrite from Austenite**



GB allotriomorphs

거의 Equiaxed 형상

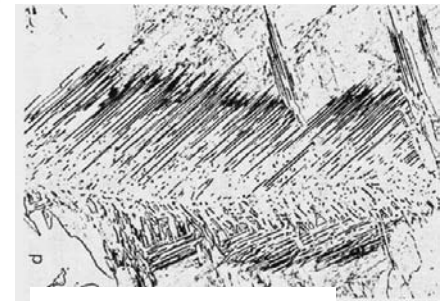
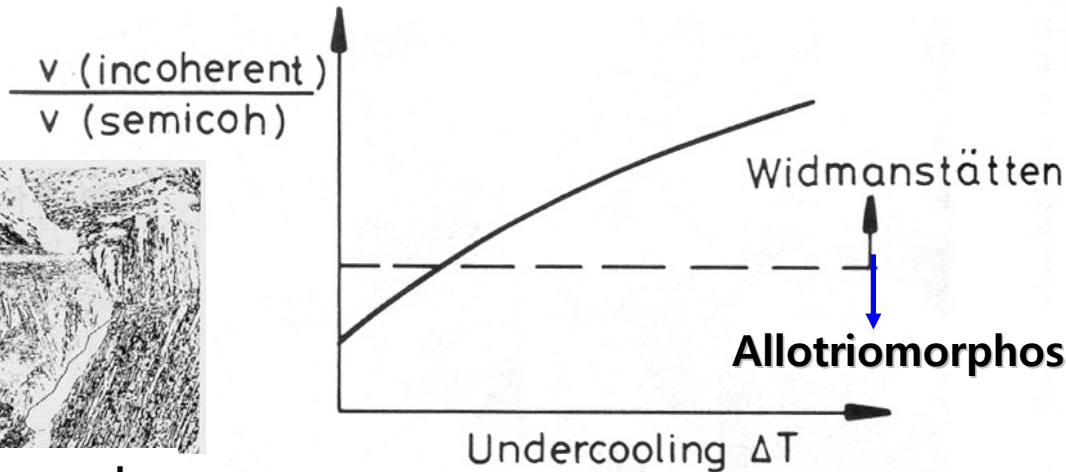

Widmanstätten

과냉도가 클수록
더 미세하게 됨

Contents for previous class

- Eutectoid, Bainite, Martensite Transformation

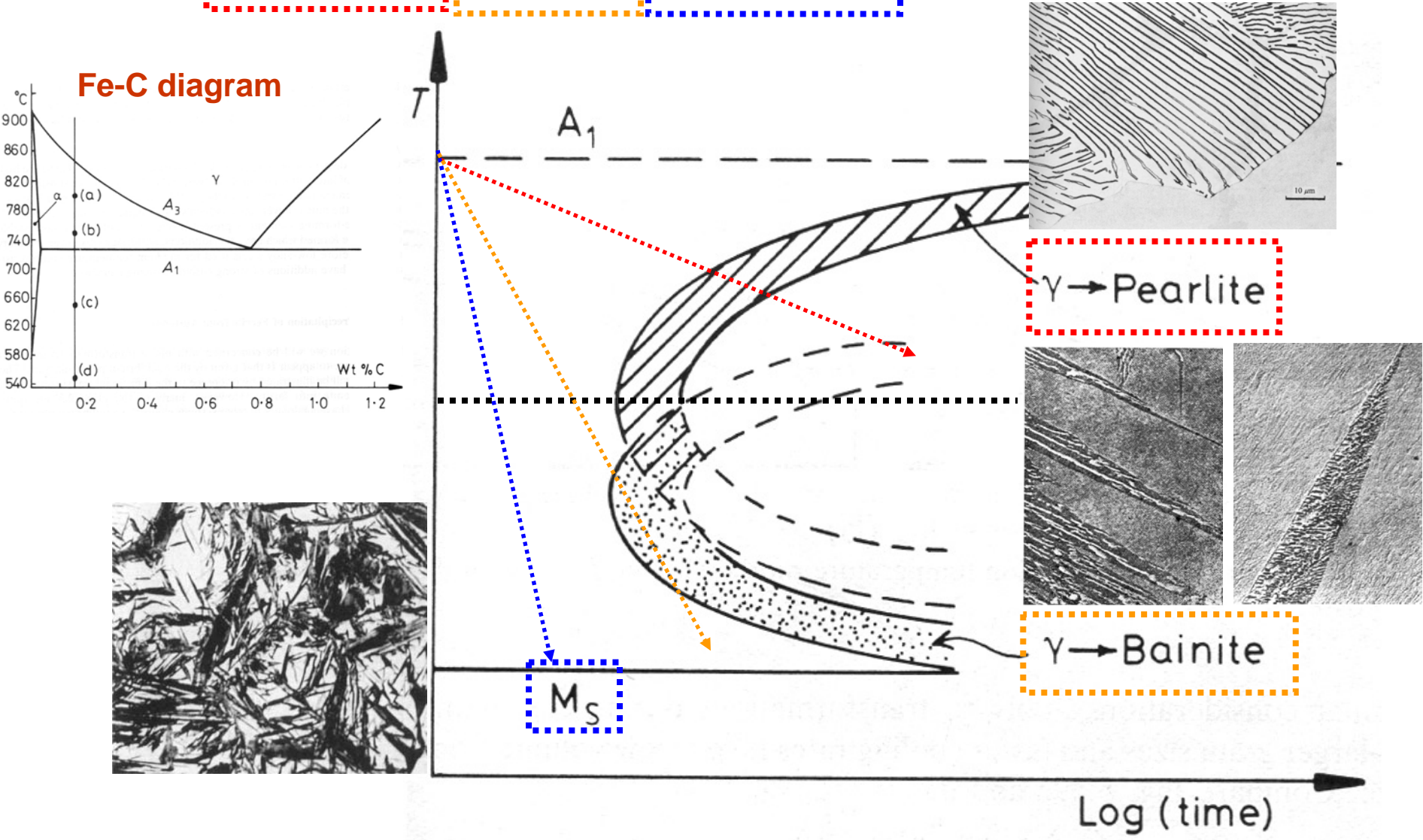

Contents for previous class

CCT diagrams

vs

TTT diagrams

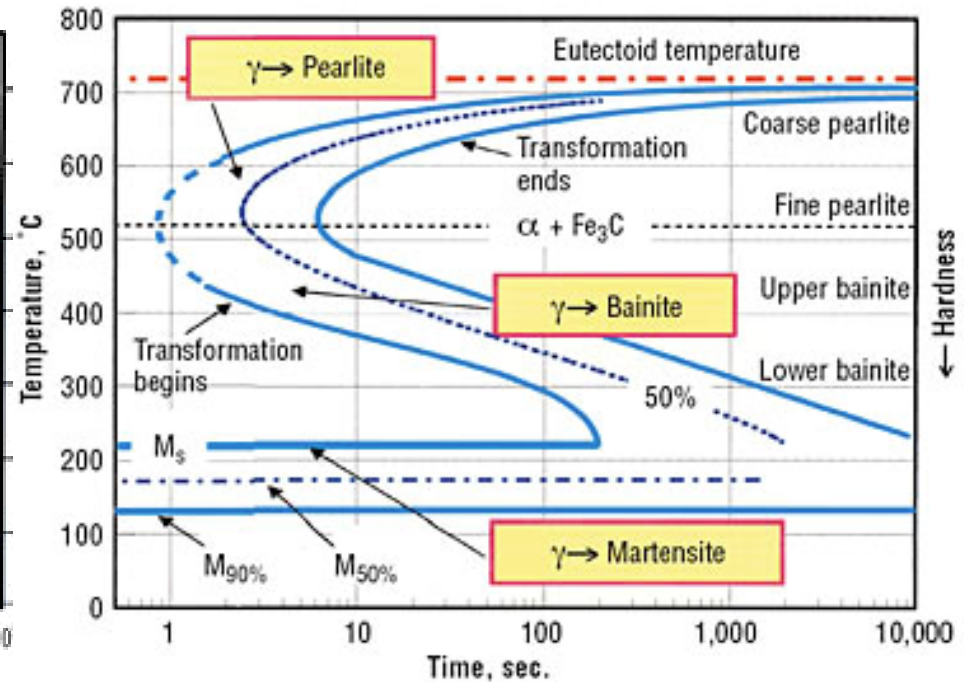
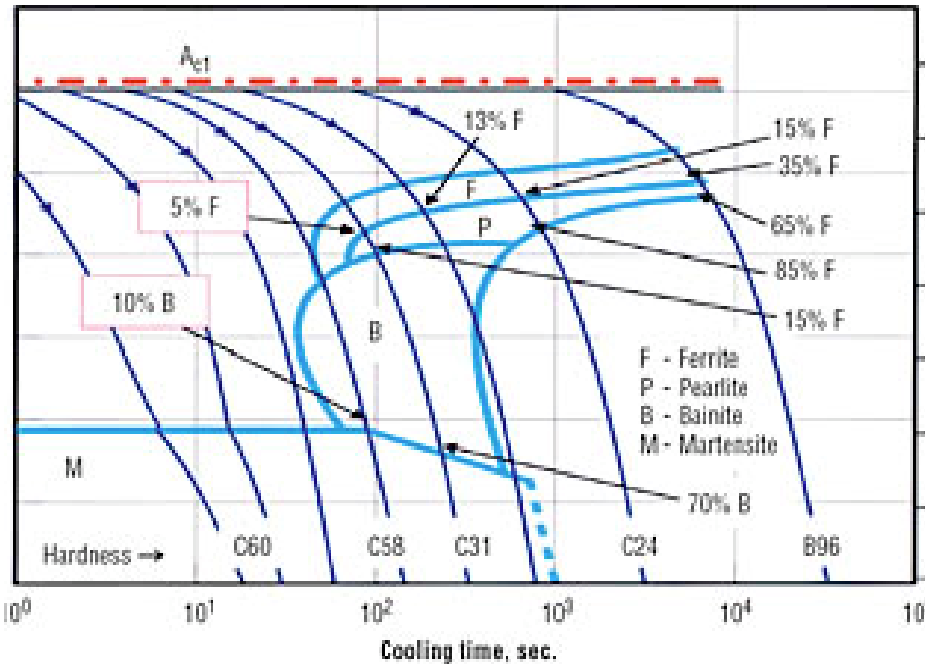

Contents for previous class

• Massive, Martensite Transformation

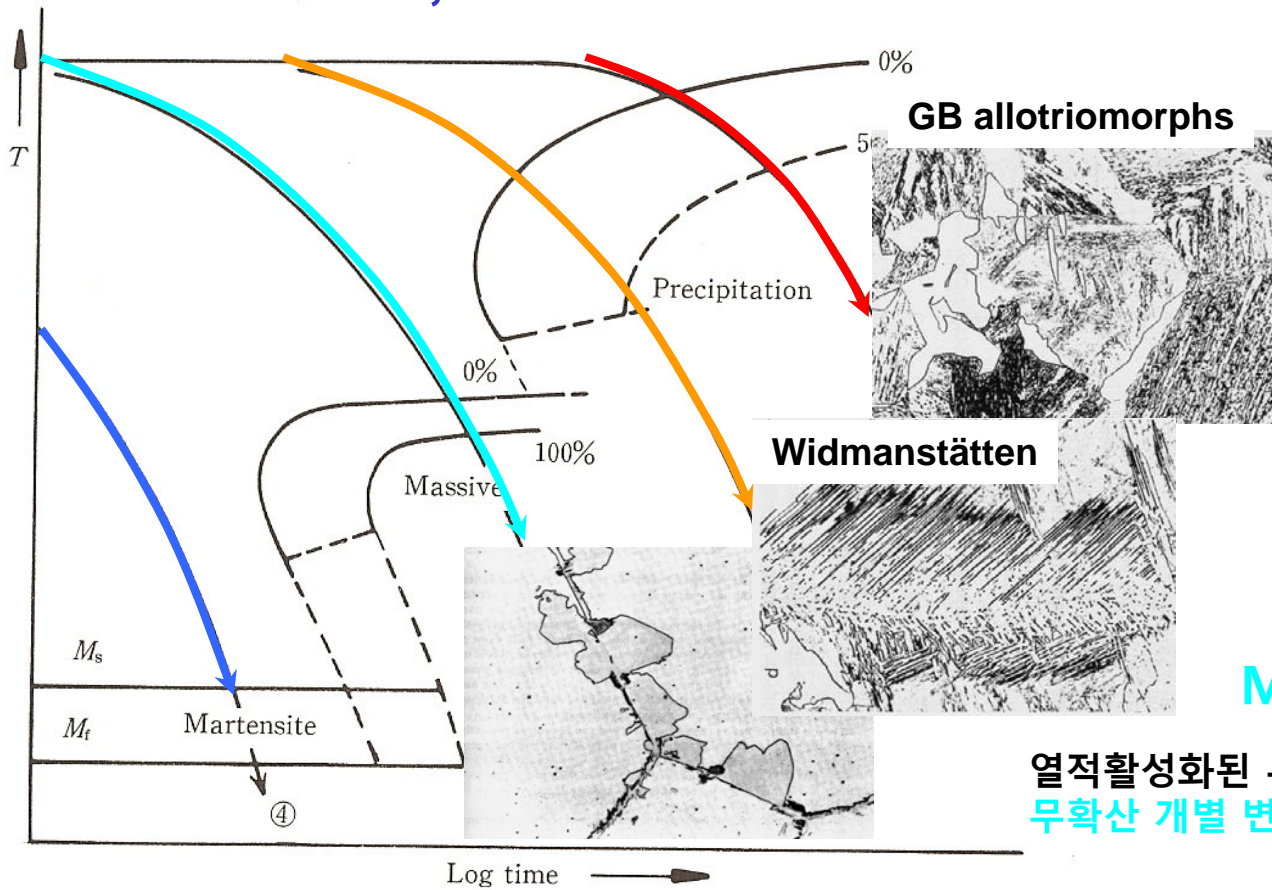

Massive Transformation

열적활성화된 부정합계면의 이동에 의한 성장:
무확산 개별 변태 (diffusionless civilian trans.)



β 상의 원자들이 협동적인 이동에 의해 평활 이동 계면을 통과하여 α 상으로 전단 변형
무확산 집단 변태 (diffusionless military trans.)

Martensite Transformation

그림 5.75 매시브 변태가 일어나는 합금계에서의 여러 가능한 연속냉각 변태곡선으로 그림 5.79를 참조하여 볼 것 ① : 서냉시 등축정 α 가 생성됨. ② 냉각속도가 증가하면 Widmanstätten 형상의 조직이 생성됨. ③ 냉각속도가 더욱 증가하면 매시브 변태가 일어남. ④ 가장 빠른 냉각속도에서는 마르텐사이트 변태가 일어남.

Contents for today's class

Chapter 6 Diffusionless Transformation

개개의 원자가 원자간 거리보다 작은 거리를 이동하여 일어남.

Martensite Transformation

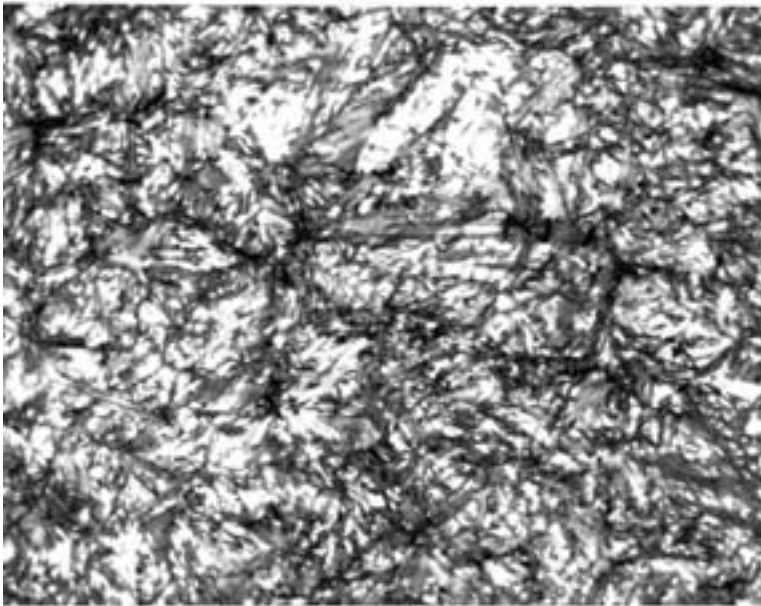

Martensite with some retained austenite



"Needle like" Structure of martensite

Named for the German metallurgist **Adolph Martens**, Martensite is **the hardened phase of steel** that is obtained by cooling Austenite fast enough to **trap carbon atoms within the cubic iron matrix** **distorting it into a body centered tetragonal structure.**

Military Transformations

- What is a martensitic transformation?

Most phase transformations studied in this course have been diffusional transformations where long range diffusion is required for the (nucleation and) growth of the new phase(s).

- There is a whole other class of *military transformations* which are *diffusionless transformations* in which the atoms move only short distances in order to join the new phase (**on the order of the interatomic spacing**).
- These transformations are *also* subject to the constraints of nucleation and growth. They are (almost invariably) associated with *allotropic transformations*.

Massive vs. Martensitic Transformations

- There are two basic types of *diffusionless* transformations.
- One is the **massive transformation**. In this type, a diffusionless transformation takes place without a definite orientation relationship. The **interphase boundary (between parent and product phases) migrates** so as to allow the new phase to grow. It is, however, a **civilian transformation** because the atoms move individually.
- The other is the **martensitic transformation**. In this type, the change in phase involves a **definite orientation relationship** because the atoms have to move in a **coordinated manner**. There is always a **change in shape** which means that there is a strain associated with the transformation. The strain is a general one, meaning that all six (independent) coefficients can be different.



Classification of Transformations

	Civilian	Military
Diffusion Required	Precipitation, Spinodal Decomposition	?
Diffusionless	Massive Transformations	Martensitic Transformations

Microstructure of Martensite

- The microstructural characteristics of martensite are:
 - the product (martensite) phase has a well defined crystallographic relationship with the parent (matrix).
 - martensite forms as **platelets within grains**.
 - each platelet is accompanied by a **shape change**.
 - the shape change appears to be a **simple shear parallel to a habit plane** (the common, coherent plane between the phases) and a **uniaxial expansion (dilatation) normal to the habit plane**.

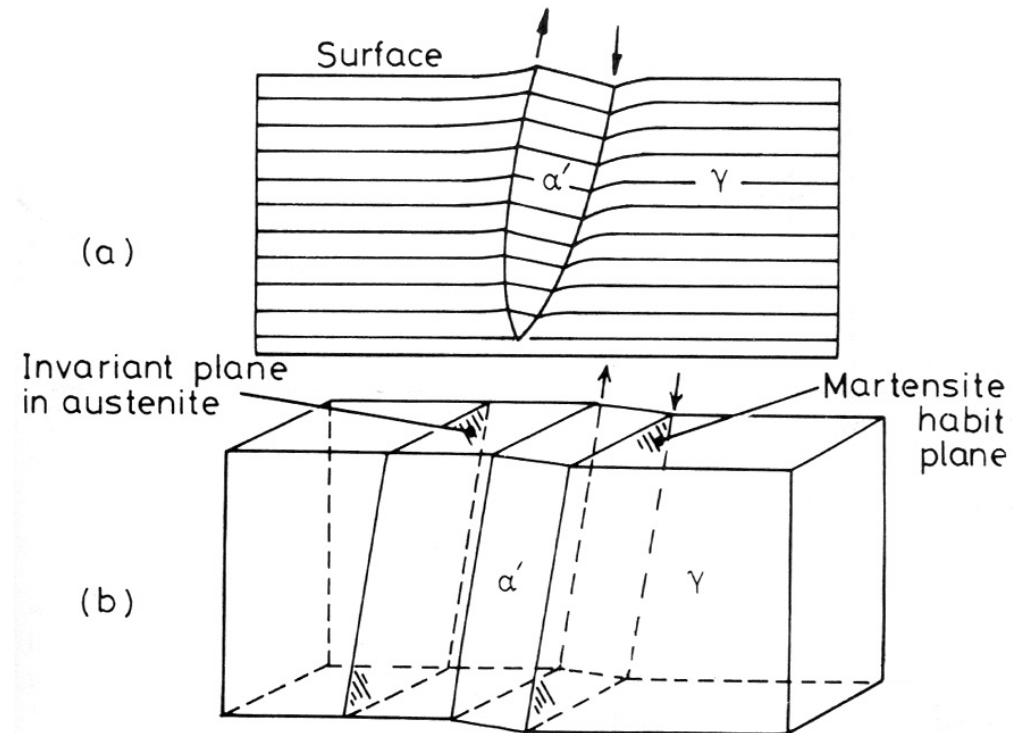
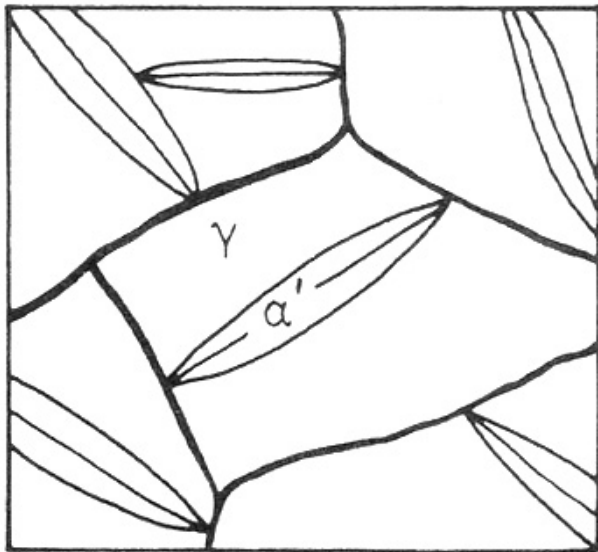

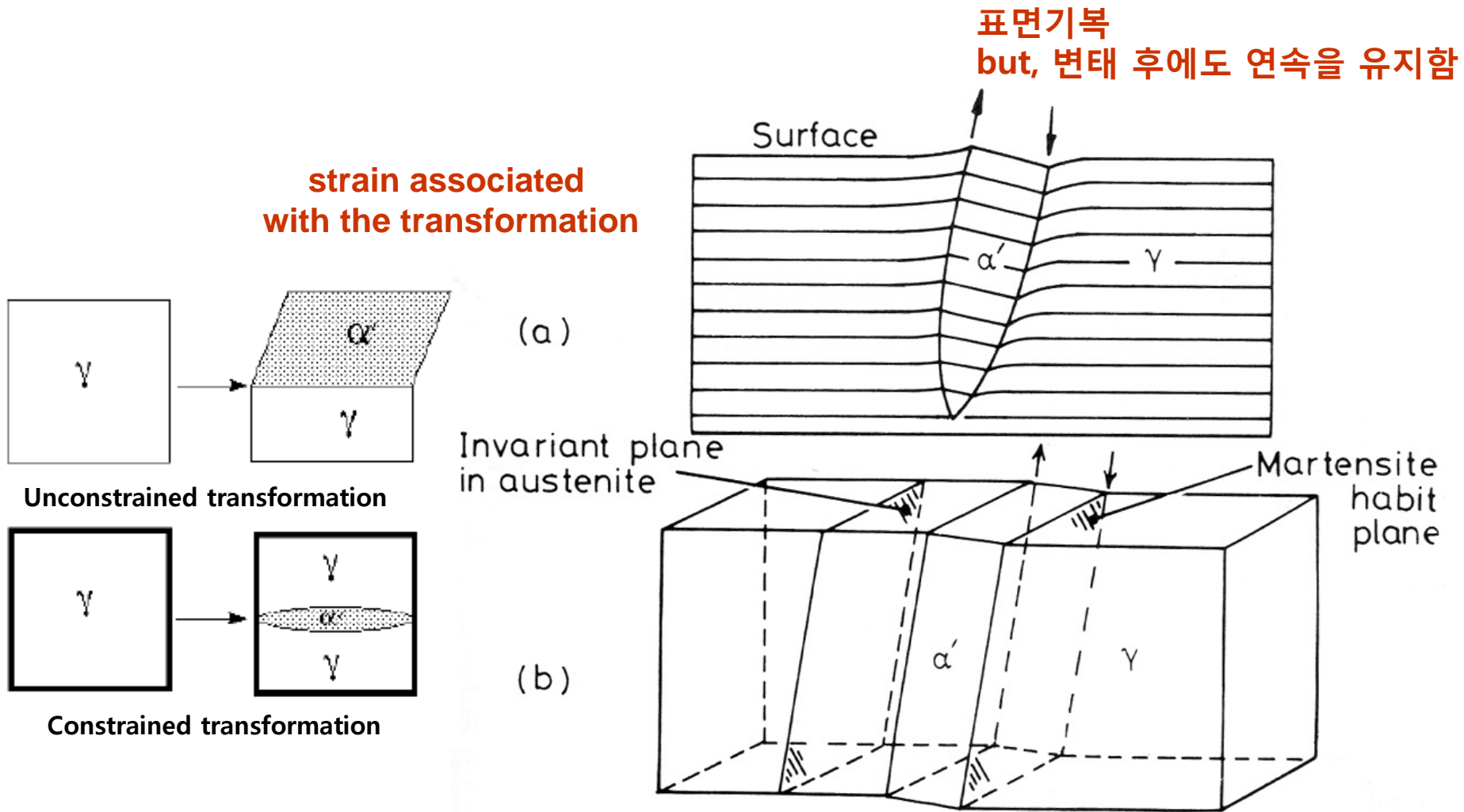
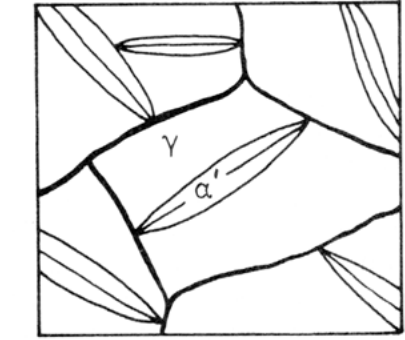
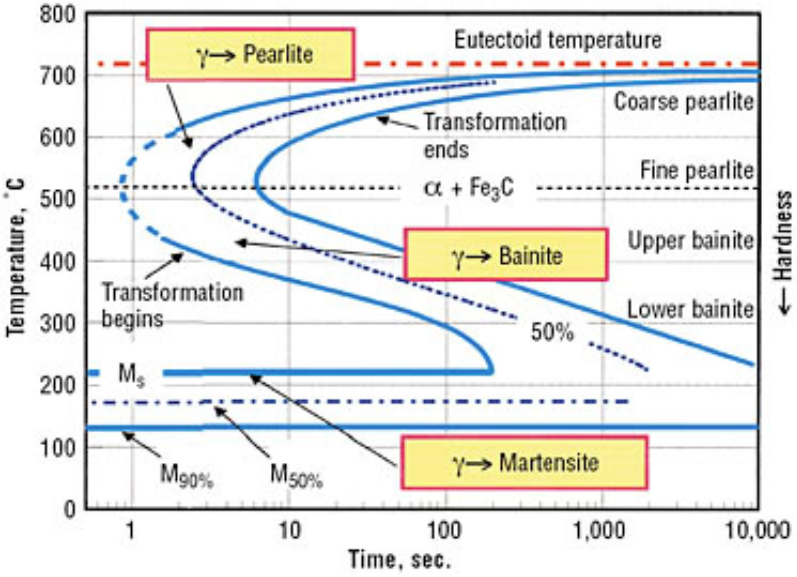
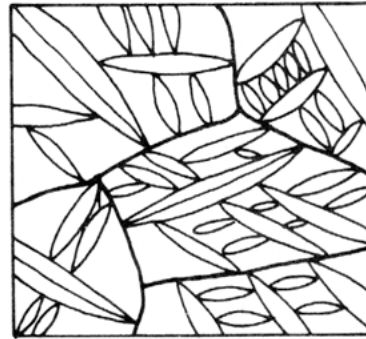

Fig. 6.2 Illustrating how a martensite plate remains (macroscopically coherent with the surrounding austenite and even the surface it intersects.

Microstructures



(a)



(b)

(c)



100 μm 저탄소강 (lath)

(d)



20 μm 중탄소강 (plate)

(e)

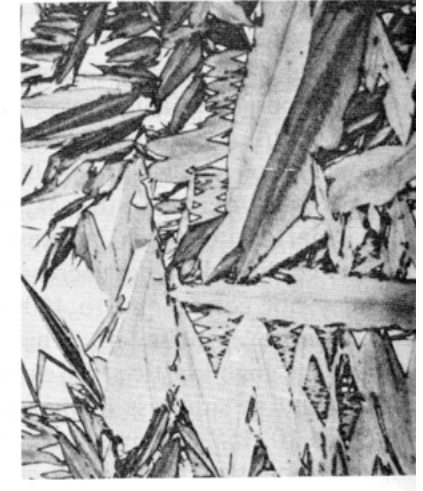

20 μm Fe-Ni (plate)

Martensite formation rarely goes to completion because of the strain associated with the product that leads to back stresses in the parent phase.

Control of Mechanical Properties By Proper Heat Treatment in Iron-Carbon Alloy



Martensite

Tip of needle shape grain

Nucleation site of fracture

Brittle



Proper
heat treatment
(tempering)

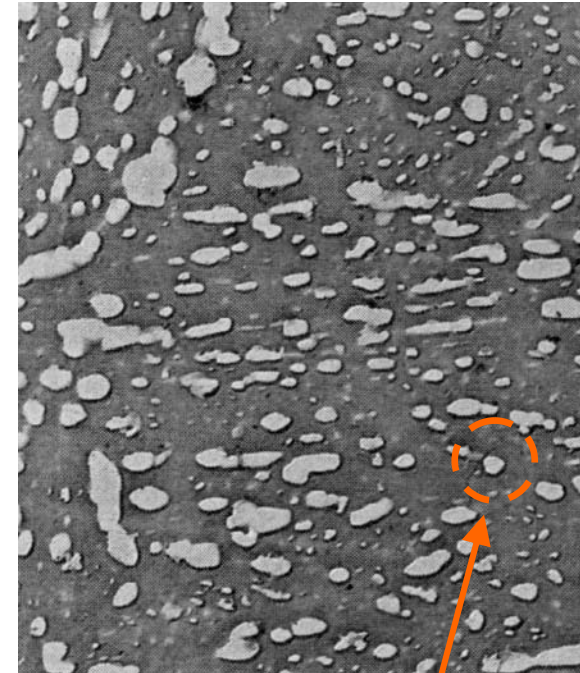

Tempered martensite

Very small & spherical shape grain

Good strength, ductility, toughness

Driving Forces

- These transformations require *larger driving forces* than for diffusional transformations.
- Why? In order for a transformation to occur without long range diffusion, it must take place *without a change in composition*.
- This leads to the so-called T_0 concept, which is the temperature at which the new phase can appear with a net decrease in free energy *at the same composition as the parent (matrix) phase*.
- As the following diagram demonstrates, the temperature, T_0 , at which segregation-less transformation becomes possible (i.e. a decrease in free energy would occur), is always less than the liquidus temperature.

Free Energy - Composition: T_0

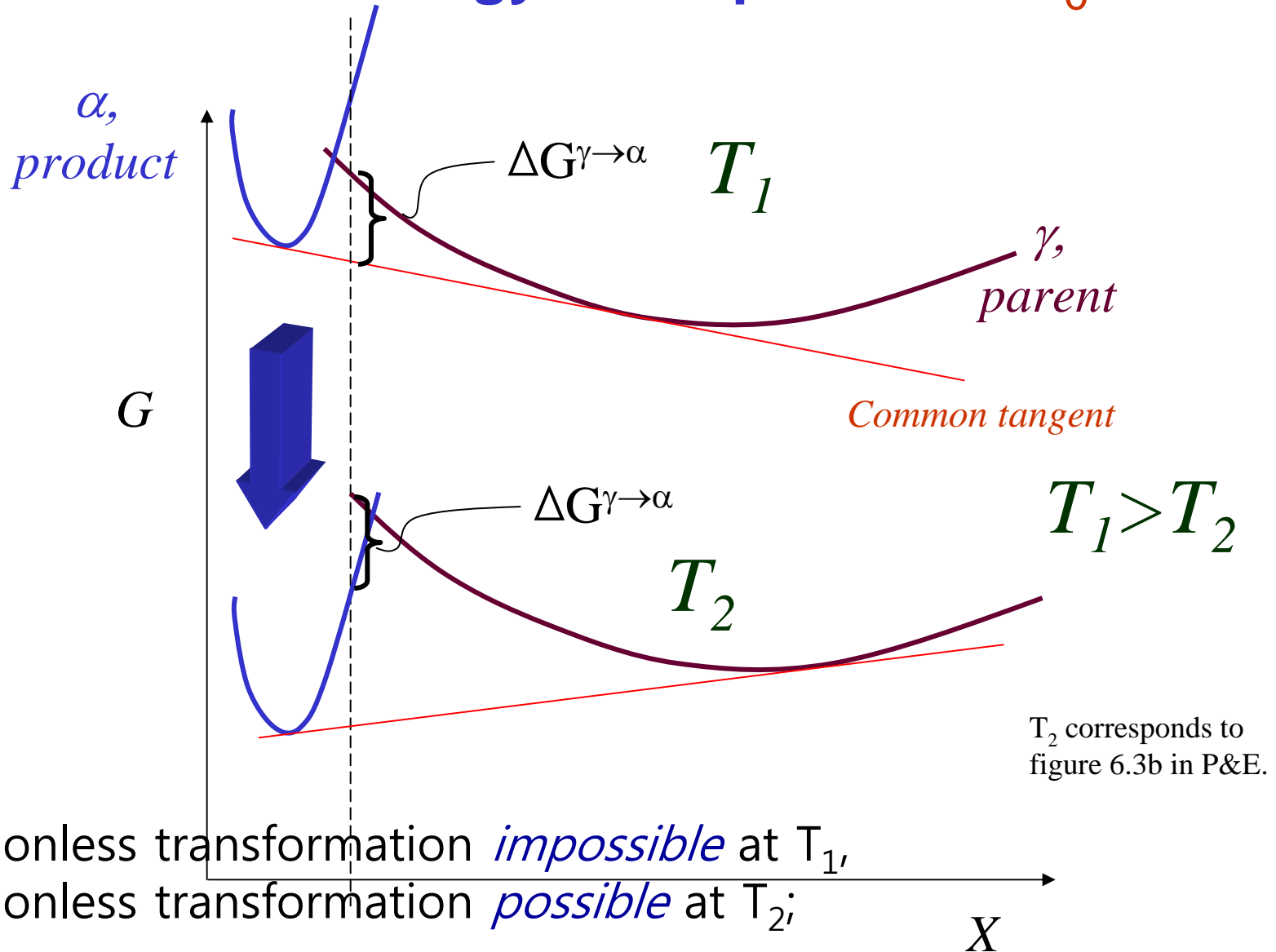

“ T_0 ” is defined by no difference in free energy between the phases, $\Delta G=0$.

Driving Force Estimation

- The driving force for a martensitic transformation can be estimated in exactly the same way as for other transformations such as solidification.
- Provided that an enthalpy (latent heat of transformation) is known for the transformation, the driving force can be estimated as proportional to the latent heat and the undercooling below T_0 .

$$\Delta G^{\gamma \rightarrow \alpha'} = \Delta H^{\gamma \rightarrow \alpha'} \Delta T / T_0 = \Delta H^{\gamma \rightarrow \alpha'} \frac{(T_0 - M_s)}{T_0}$$

Alloy	$\Delta H^{\gamma \rightarrow \alpha'}$ (J mol ⁻¹)	$T_0 - M_s$ (K)	$-\Delta G^{\gamma \rightarrow \alpha'}$ (J mol ⁻¹)
Ti-Ni	1550	20	92
Cu-Al	170-270	20-60	19.3 ± 7.6
Au-Cd	290	10	11.8
Fe-Ni 28%	1930	140	840
Fe-C			1260
Fe-Pt 24% ordered	340	10	17
Fe-Pt disordered	2390	~150	~1260

규칙합금의 경우, 작은 과냉도에서도 마텐사이트를 얻을 수 있음.

Various ways of showing the martensite transformation

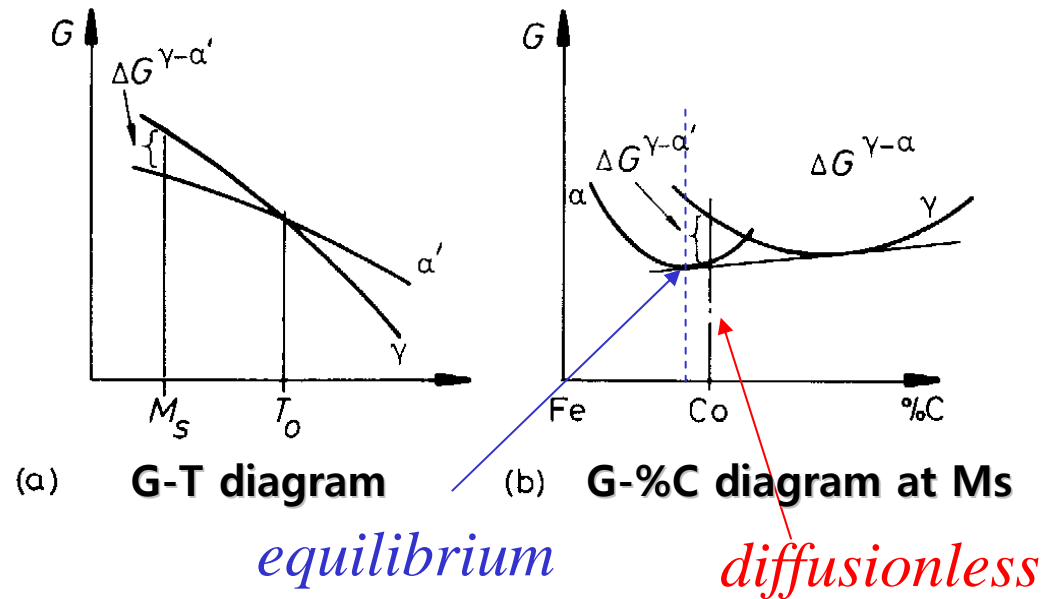

Note that the M_s line is horizontal in the TTT diagram; also, the M_f line.

M_f 온도 이하에서도 잔류 오스테 나이트 남아 있는 경우가 있음. 특히, 고탄소 합금강의 경우 10~15% 정도의 많은 양이 잔류함.

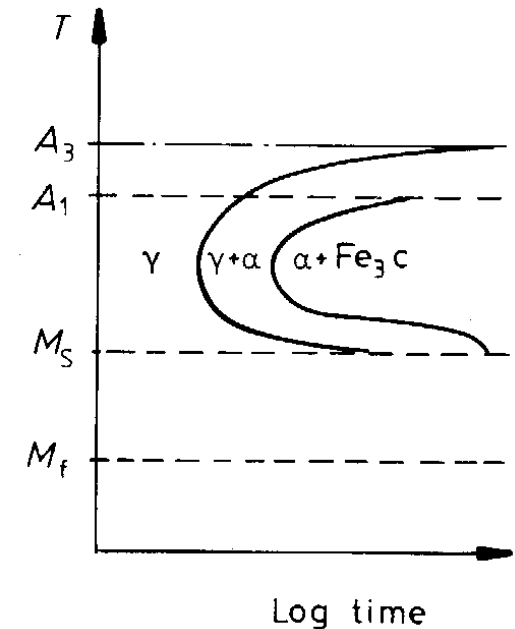
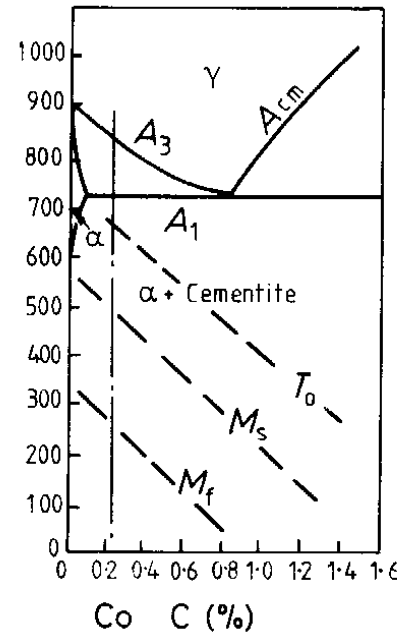

(c) **Variation of T_0**

(d) **C_0 합금의 TTT curve**

Heterogeneous Nucleation

- Why does martensite not form until well below the T_0 temperature?

The reason is that a finite driving force is required to supply the energy needed for (a) the interfacial energy of the nucleus and (b) the elastic energy associated with the transformation strain. The former is a small quantity (estimated at 0.02 Jm^{-2}) but the elastic strain is large (estimated at 0.2 Jm^{-2} in the Fe-C system), see section 6.3.1 for details. Therefore the following (standard) equation applies.

$$\Delta G^* = 16\pi\gamma^3 / 3(\Delta G_V - \Delta G_S)^2$$

- Why does martensite require heterogeneous nucleation?

The reason is the large critical free energy for nucleation outlined above.

- Dislocations in the parent phase (austenite) clearly provide sites for heterogeneous nucleation.
- Dislocation mechanisms are thought to be important for propagation/growth of martensite platelets or laths.

Mechanisms

- The mechanisms of martensitic transformations are not entirely clear.
The small length scales mean that the *reactions propagate at high rates* - close to the speed of sound. The high rates are possible because of the absence of long range atomic movement (via diffusion).
- Possible mechanisms for martensitic transformations include
 - (a) dislocation based
 - (b) shear based
- Martensitic transformations strongly constrained by crystallography of the parent and product phases.
- This is analogous to *slip (dislocation glide)* and *twinning*, especially the latter.

Atomic model - the Bain Model

- For the case of **FCC Fe transforming to BCT ferrite** (Fe-C martensite), there is a basic model known as the **Bain model**.
- The essential point of the Bain model is that it accounts for the structural transformation with a *minimum of atomic motion*.
- Start with two fcc unit cells: contract by 20% in the z direction, and expand by 12% along the x and y directions.

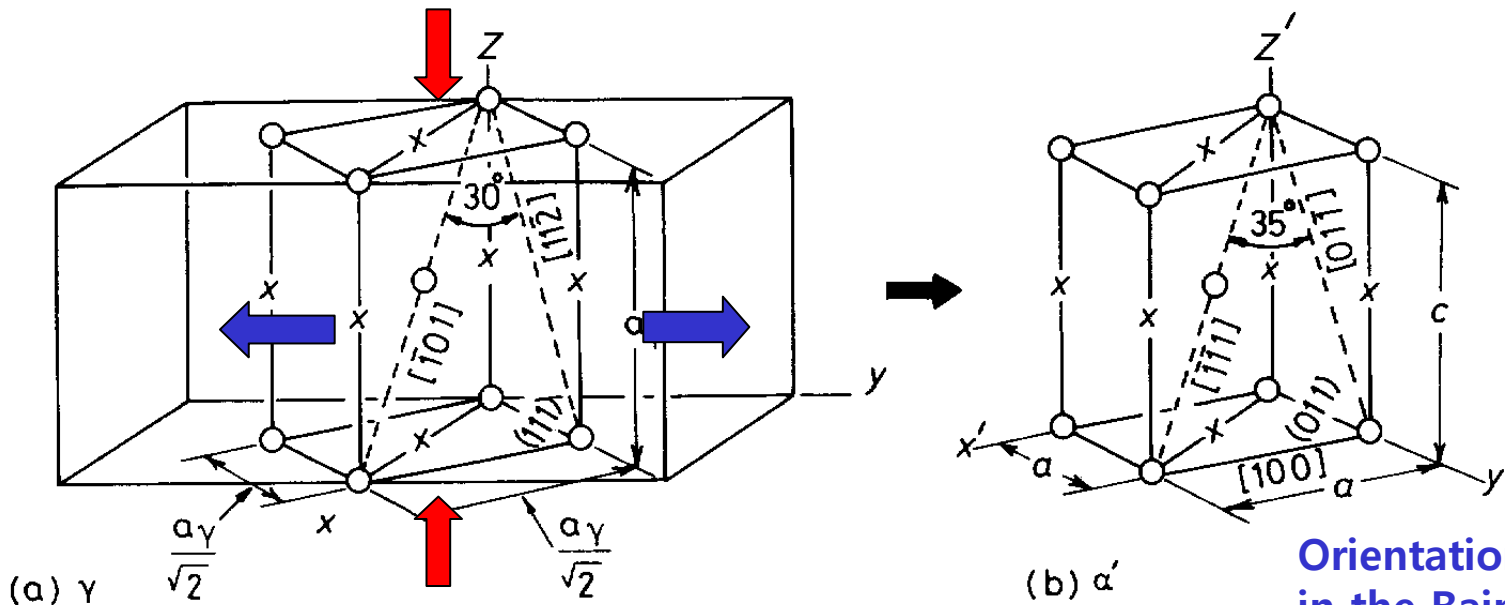

Bain Model of the FCC to BCT Transformation

Orientation relationships in the Bain model are:

$$\begin{aligned}
 (111)_\gamma &\rightarrow (011)_{\alpha'} \\
 [101]_\gamma &\rightarrow [111]_{\alpha'} \\
 [110]_\gamma &\rightarrow [100]_{\alpha'} \\
 [112]_\gamma &\rightarrow [011]_{\alpha'}
 \end{aligned}$$

Crystallography, contd.

- Although the Bain model explains several basic aspects of martensite formation, additional features must be added for complete explanations (not discussed here).
- The missing component of the transformation strain is an additional shear that changes the character of the strain so that an invariant plane exists. This is explained in fig. 6.8.

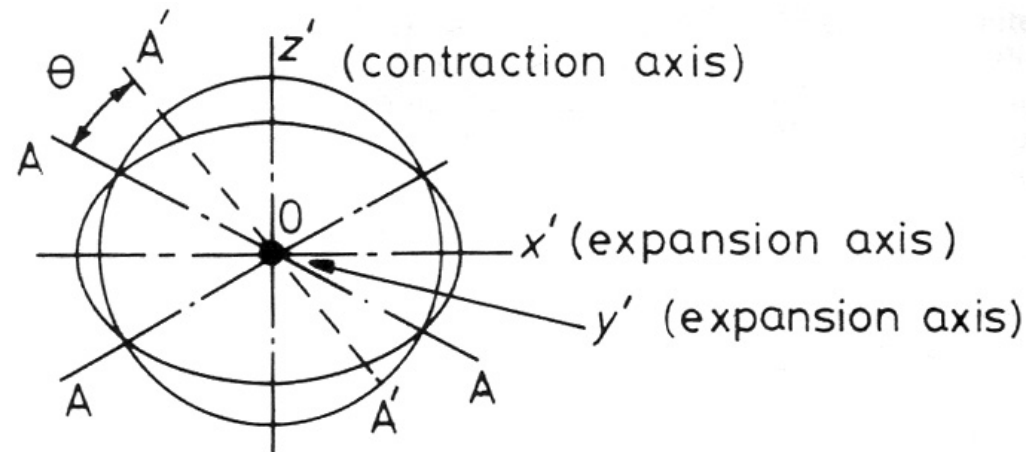
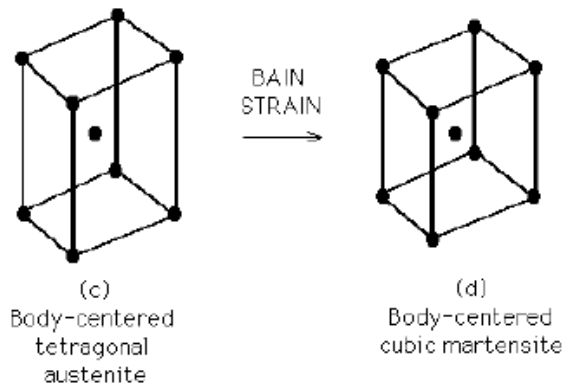
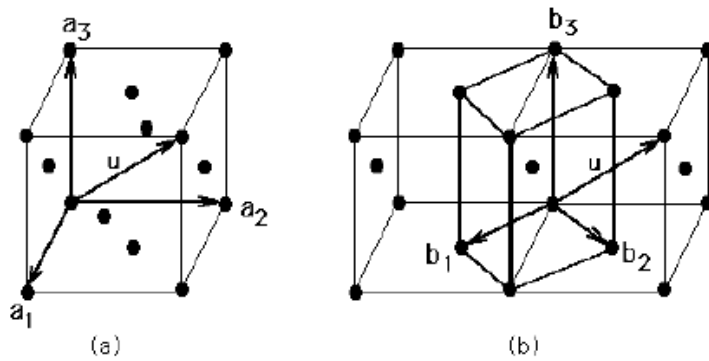

2 개의 축방향으로 팽창이 일어나고
나머지 1개의 축으로는 수축이 일어남

Bain 변형은 마르텐사이트 변태시 변형되지 않는 평면이 존재하여야 한다는 조건을 만족시키지 못한다. 따라서 마르텐 사이트 변태의 결정학적 이론의 열쇠는 앞의 그림에 나타난 것처럼 y' 축으로 길이 증가를 줄여 길이 증가가 0이 되도록 할 수 있는 새로운 변형을 제한하는 것이다.

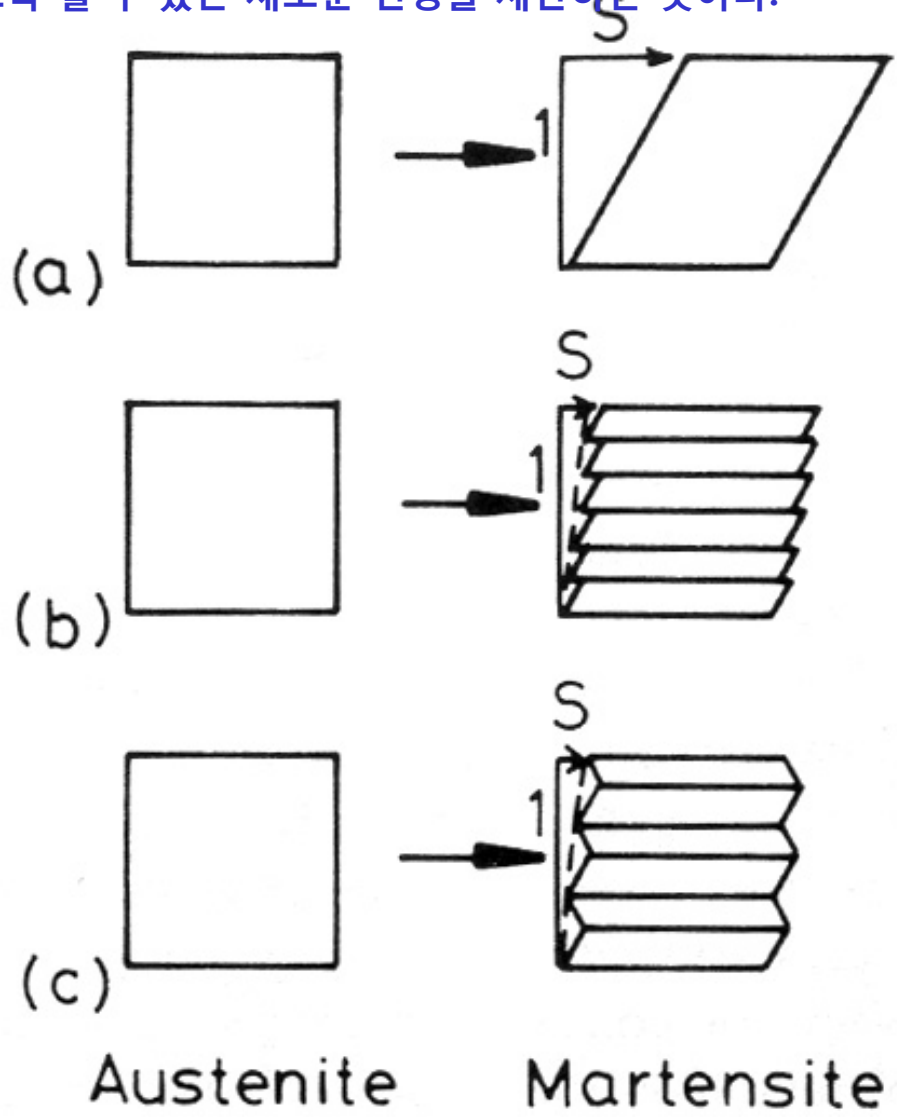

마르텐사이트 변태시 전위의 활주 또는 쌍정에 의하여 Bain 변형에서와 같은 순격자변형이 많이 상쇄될 수 있음.

Bain 모델에 쌍정변형을 적용하면,

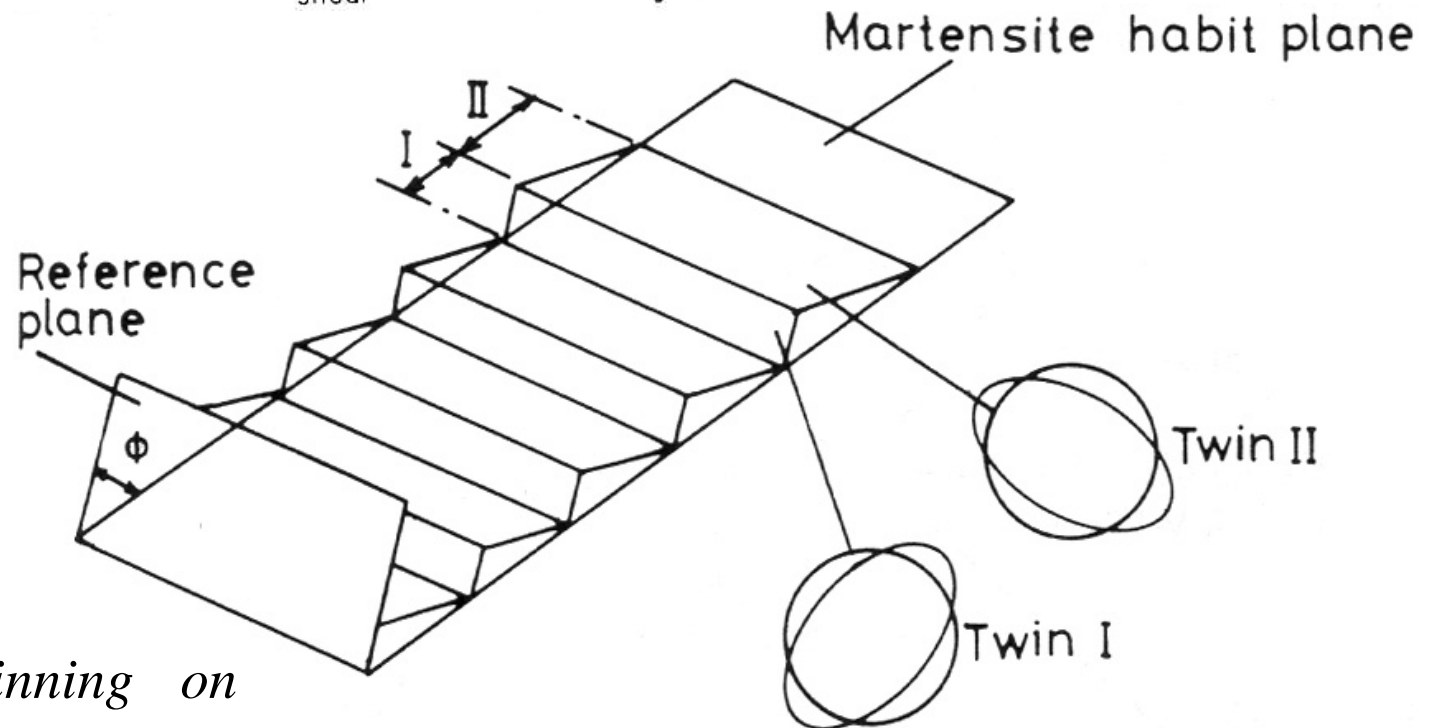
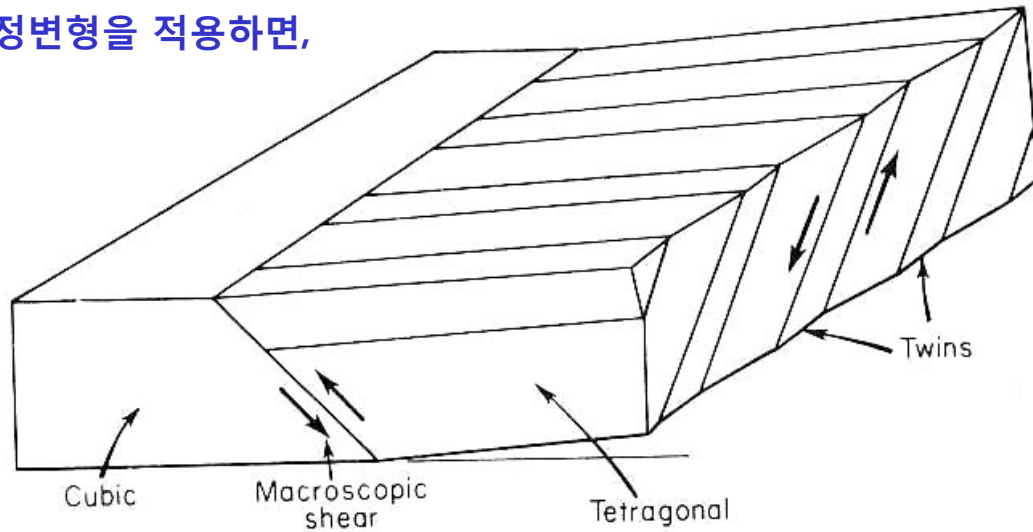

Slip or Twinning on

$$\{11\bar{2}\} \langle 111 \rangle \text{ in } \alpha \quad \{110\} \langle 1\bar{1}0 \rangle \text{ in } \gamma$$

Phenomenological theory of martensite crystallography

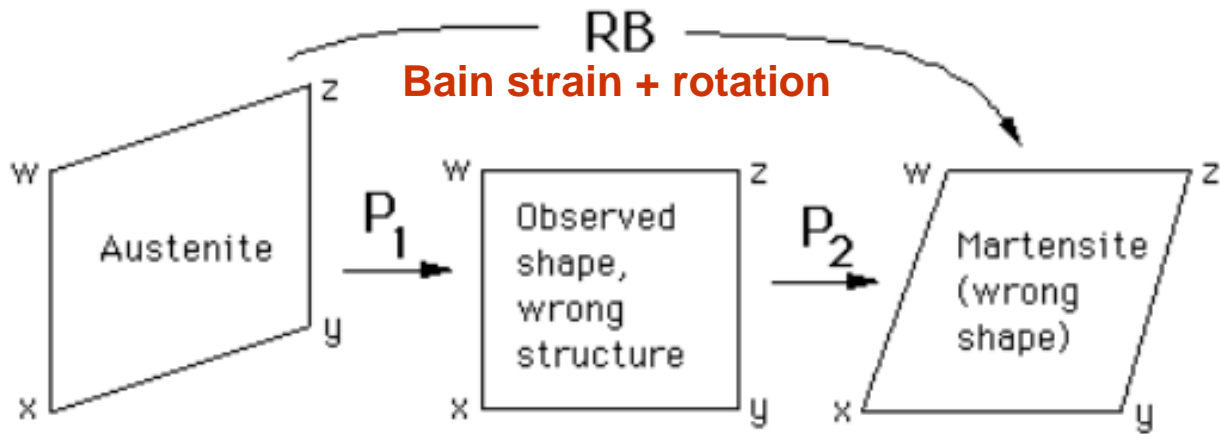

(a) Invariant-plane strain (b) Second homogeneous shear (c)

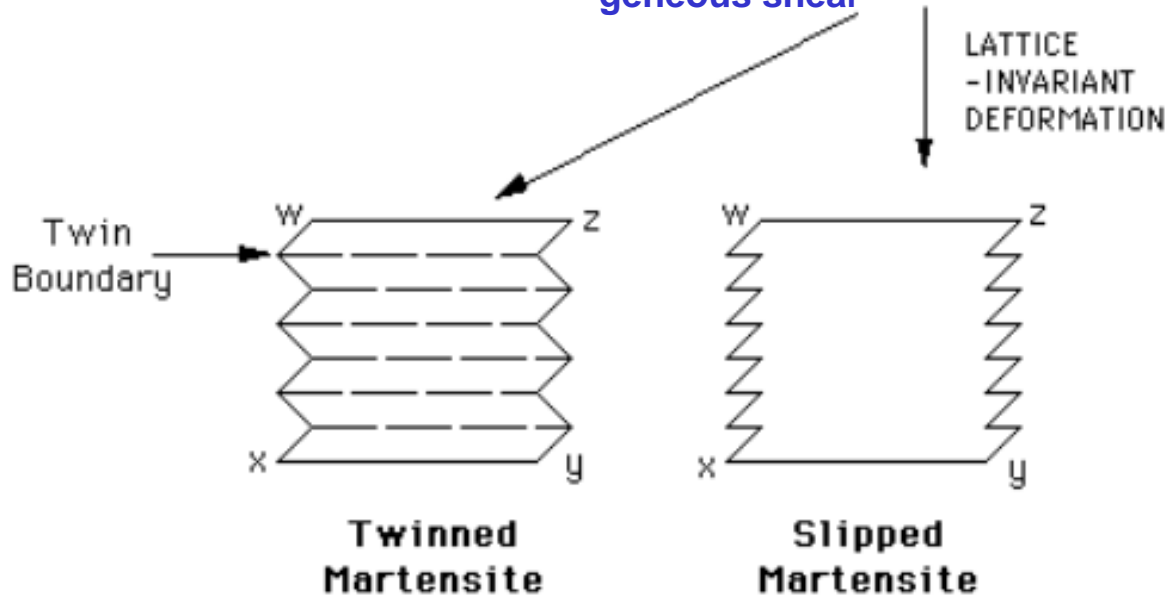

Correct macroscopic shape, correct structure

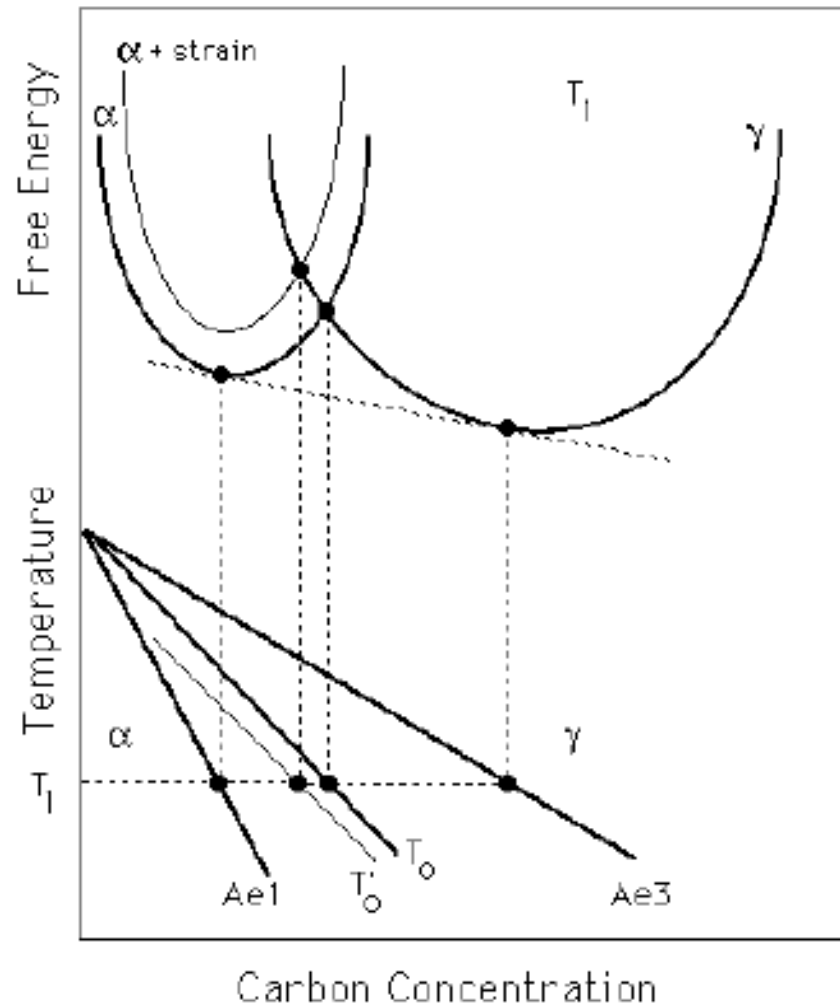

Martensite transformation is only possible below the T_0' temperature.

Fig. 8: Schematic illustration of the origin of the T_0' curve on the phase diagram. The T_0' curve incorporates a strain energy term for the ferrite, illustrated on the diagram by raising the free energy curve for ferrite by an appropriate quantity.

Why tetragonal Fe-C martensite?

- At this point, it is worth stopping to ask why a **tetragonal martensite** forms in iron. The answer has to do with the **preferred site for carbon as an interstitial impurity in bcc Fe**.
- Remember: Fe-C martensites are unusual for being **so strong (& brittle)**. Most martensites are not significantly stronger than their parent phases.
- Interstitial sites:
 - fcc: **octahedral** sites radius= 0.052 nm
 - tetrahedral sites radius= 0.028 nm
 - bcc: **octahedral** sites radius= 0.019 nm
 - tetrahedral sites radius= 0.036 nm
- Carbon atom radius = 0.08 nm.
- Surprisingly, it occupies the octahedral site in the bcc Fe structure, despite the smaller size of this site (compared to the tetrahedral sites) presumably because of the **low modulus in the <100> directions**.

Interstitial sites for C in Fe

fcc:

carbon occupies the
octahedral sites

bcc:

carbon occupies the
octahedral sites

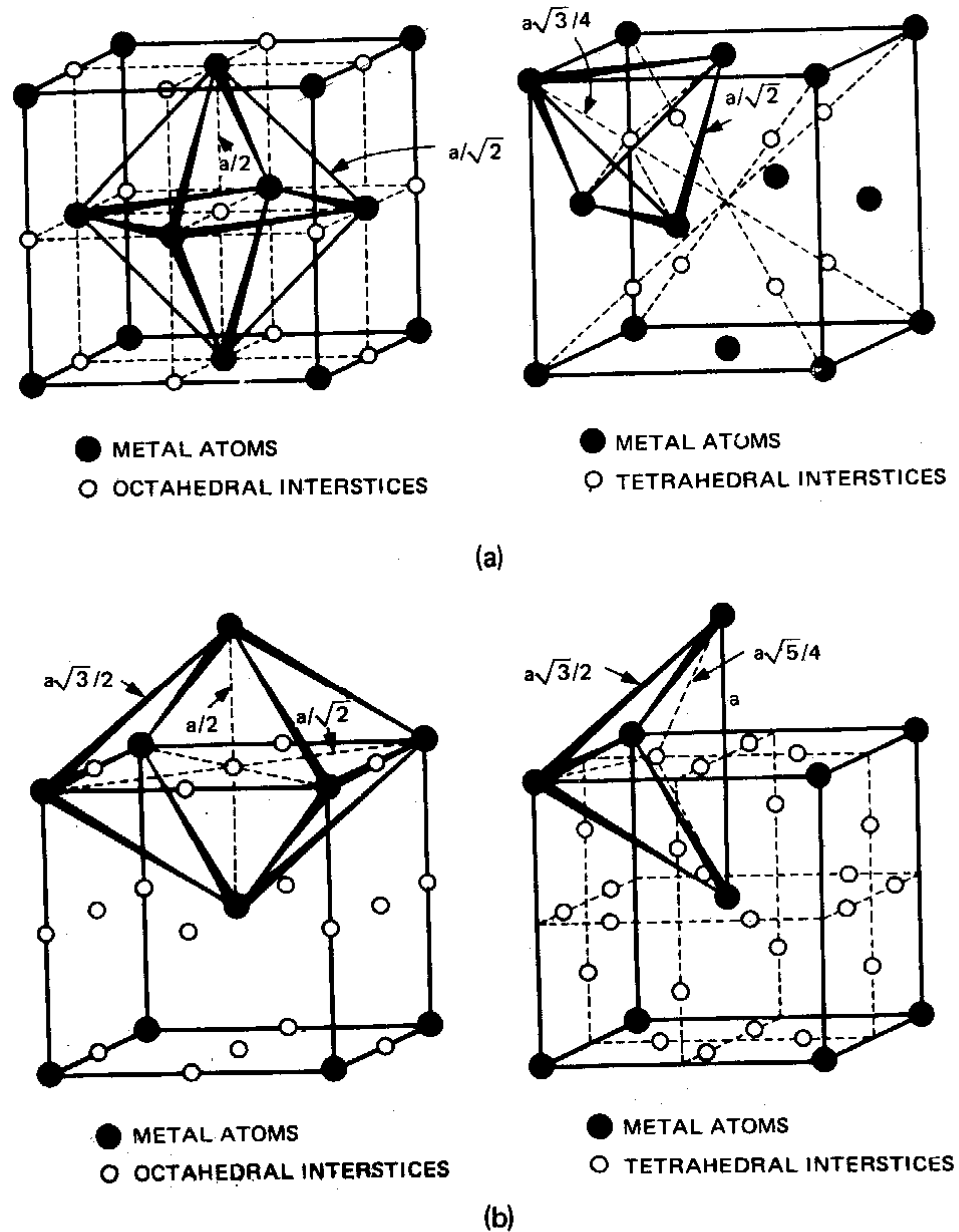

[Leslie]

Figure II-1. Interstitial voids in iron. (a) Interstitial voids in the fcc structure, octahedral (1) and tetrahedral (2). (b) Interstitial voids in the bcc structure; octahedral (1) and tetrahedral (2). (From C.S. Barrett and T.B. Massalski, *Structure of Metals*, 3d ed., copyright 1966, used with the permission of McGraw-Hill Book Co., New York.)

Carbon in ferrite

- One consequence of the occupation of the octahedral site in ferrite is that the carbon atom has only two nearest neighbors.
- Each carbon atom therefore distorts the iron lattice in its vicinity.
- The distortion is a *tetragonal distortion*.
- If all the carbon atoms occupy the *same type of site* then the entire lattice becomes *tetragonal*, as in the *martensitic structure*.
- Switching of the carbon atom between adjacent sites leads to strong internal friction peaks at characteristic temperatures and frequencies.

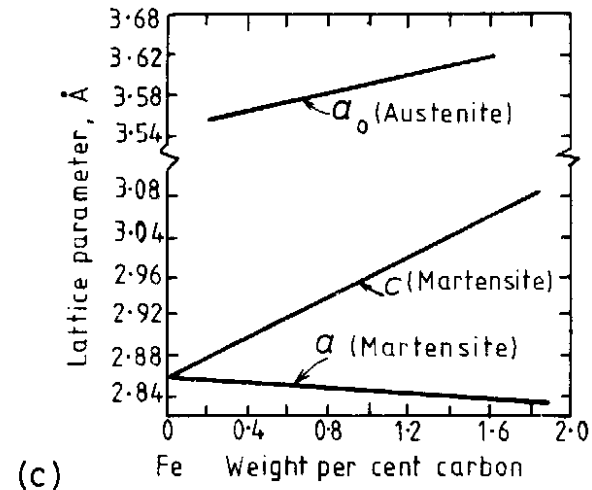
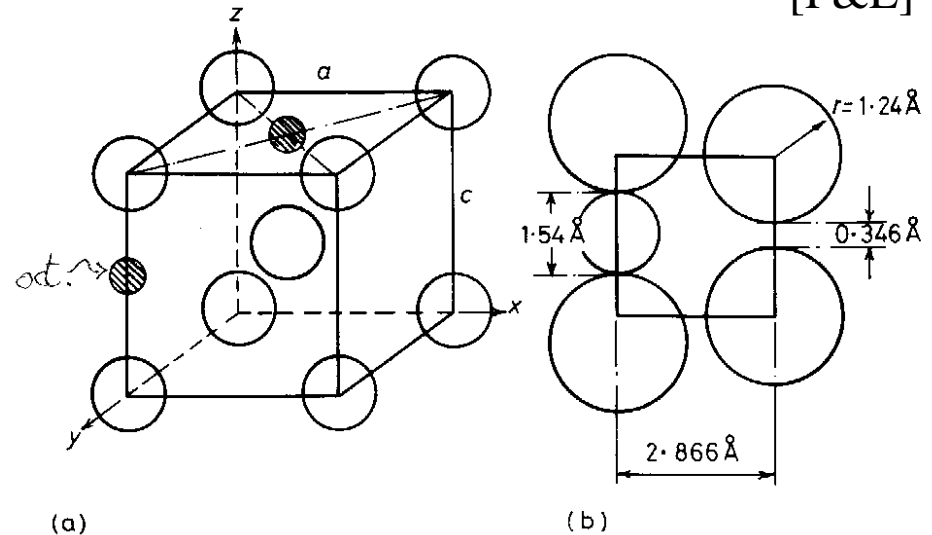
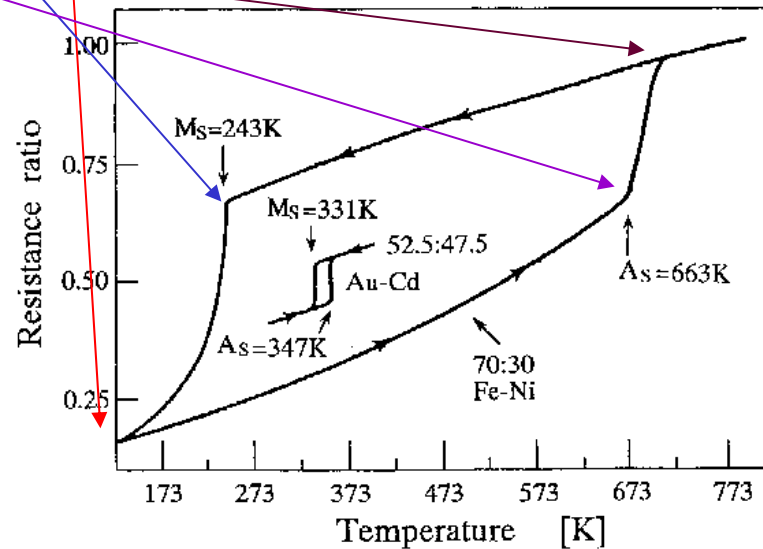

Fig. 6.5 Illustrating (a) possible sites for interstitial atoms in bcc lattice, and (b) the large distortion necessary to accommodate a carbon atom (1.54 Å diameter) compared with the space available (0.346 Å). (c) Variation of a and c as a function of carbon content. (After C.S. Roberts, *Transactions AIME* 191 (1953) 203.)

Shape Memory Effect (SME)

- General phenomenon associated with martensitic transformations.
- Characteristic feature = *strain induced martensite* (SIM), capable of *thermal reversion*.
- *Ferroelasticity* and *Superelasticity* also possible.
- $M_d, A_f, A_s, A_d, M_s, M_f$ temperatures.



[Shape Memory Materials]

Fig. 1.16. Electrical resistance changes during cooling and heating Fe–Ni and Au–Cd alloys, illustrating the hysteresis of the martensitic transformation on cooling, and the reverse transformation on heating, for non-thermoelastic and thermoelastic transformations respectively. (After Kaufman and Cohen³⁷)

Principle of Shape Memory Alloys

Ni-Ti alloys

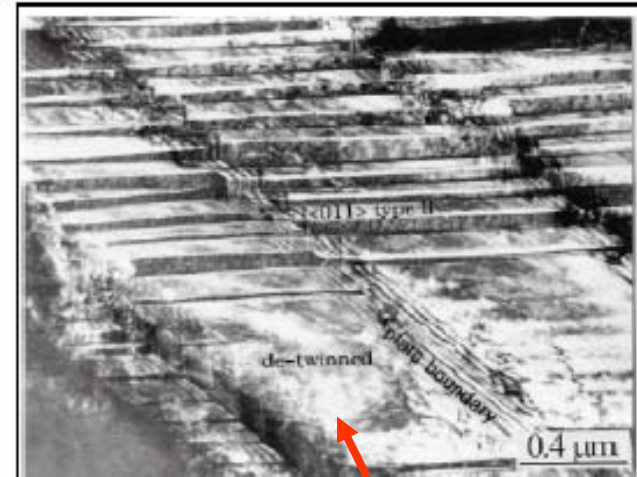
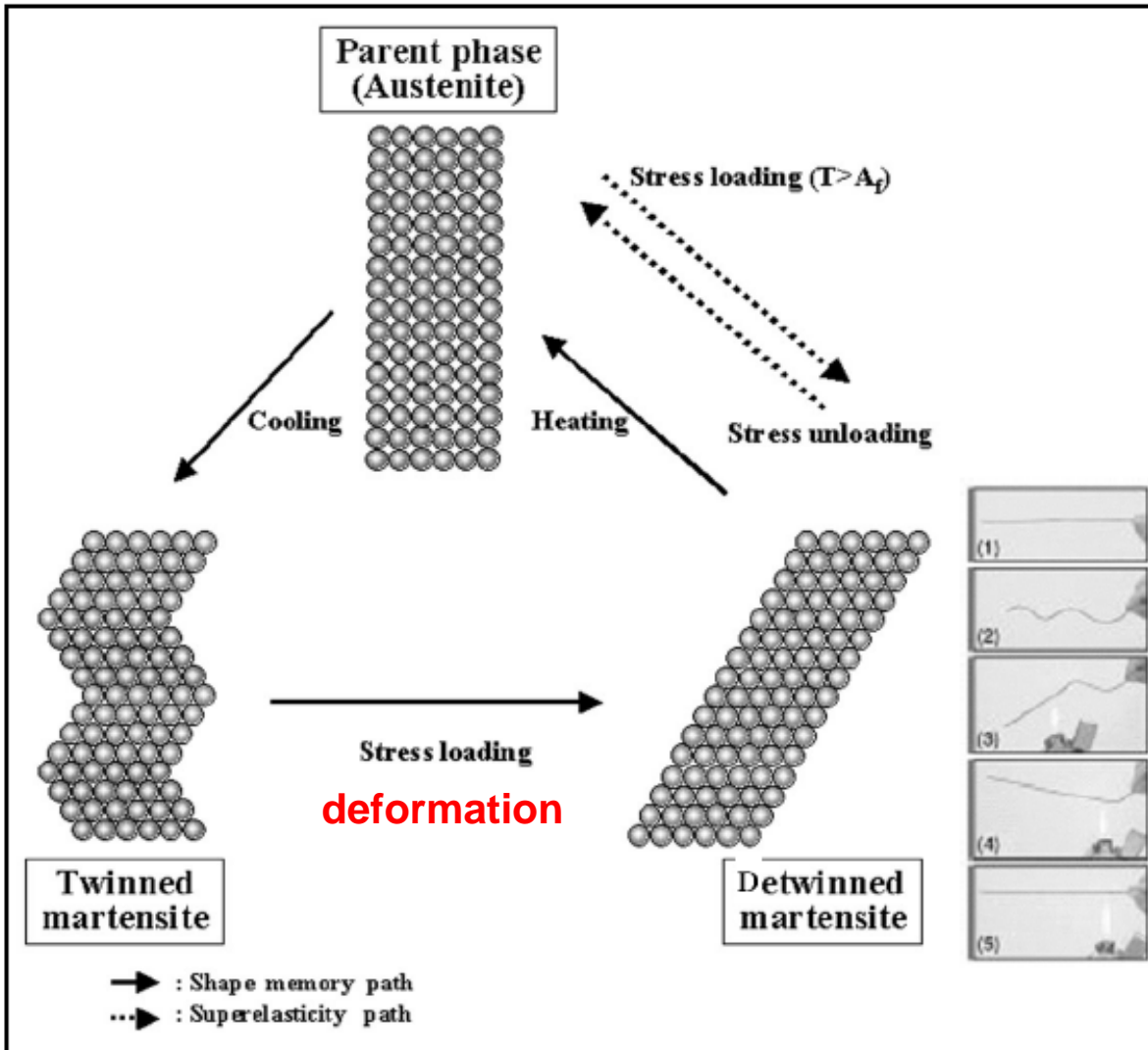

Detwinned martensite

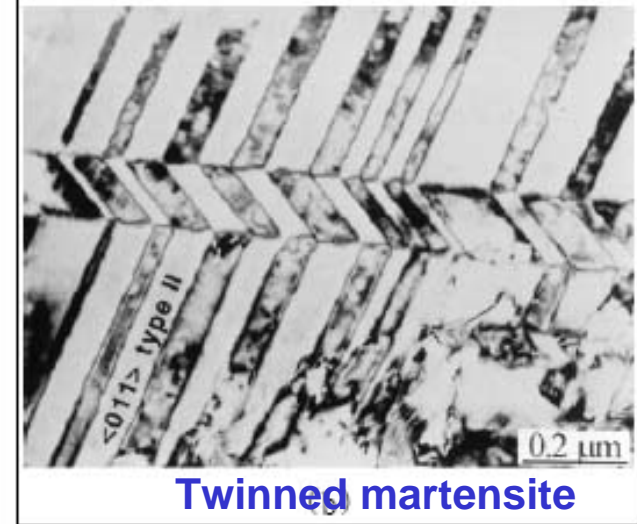

Twinned martensite

Shape Memory Alloy's applications can be used in many ways depends on the use of YOUR IDEAS.

Magic flower

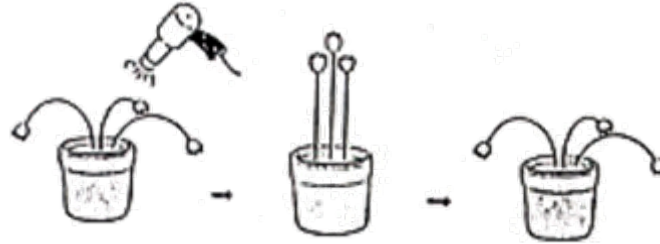

Magic spring (climb koala)

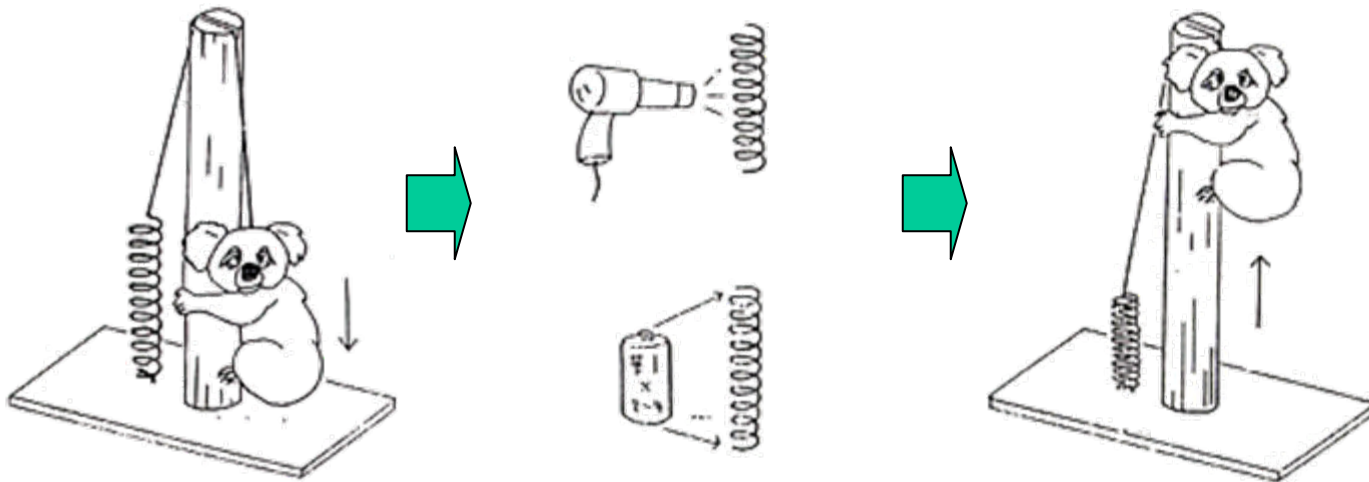

Application of Shape Memory Alloys



Seoul National University
Mechanical & Aerospace Eng.
Biorobotics Laboratory

Contents in Phase Transformation

상변태를
이해하는데
필요한 배경

(Ch1) 열역학과 상태도: Thermodynamics

(Ch2) 확산론: Kinetics

(Ch3) 결정계면과 미세조직: Interfaces

대표적인 상변태

(Ch4) 응고: Liquid \rightarrow Solid

(Ch5) 고체에서의 확산 변태: Solid \rightarrow Solid (Diffusional)

(Ch6) 고체에서의 무확산 변태: Solid \rightarrow Solid (Diffusionless)

Materials Tetrahedron

Alloy Design & Processing

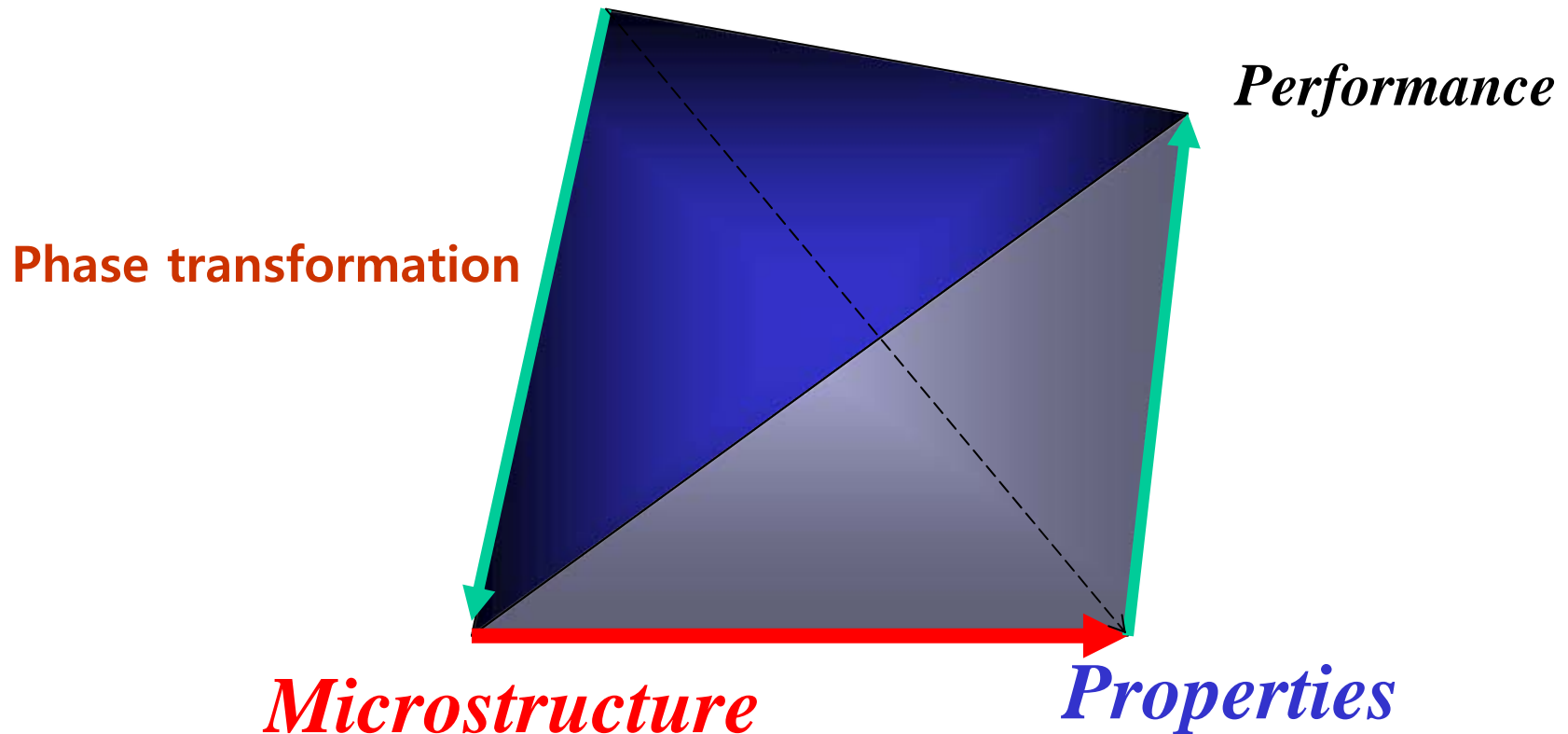

Materials Science and Engineering