

# Lecture Note #10

## **Spectroelectrochemistry 1 (ch. 17): *in situ & ex situ***

### **1. UV & visible spectroscopy**

**(1) Transmission experiments**

**(2) Ellipsometry**

**(3) Internal reflection spectroelectrochemistry: surface plasmon resonance**

**(4) Second harmonic spectroscopy**

### **2. Vibrational spectroscopy:**

**(1) IR spectroscopy**

**(2) Raman spectroscopy**

### **3. Electron & ion spectroscopy**

**XPS, AES, LEED, HREELS, mass spectroscopy**

**4. Magnetic resonance methods: ESR, NMR**

**5. Quartz crystal microbalance**

**6. X-ray methods: XAS, XRD**

# Electromagnetic radiation

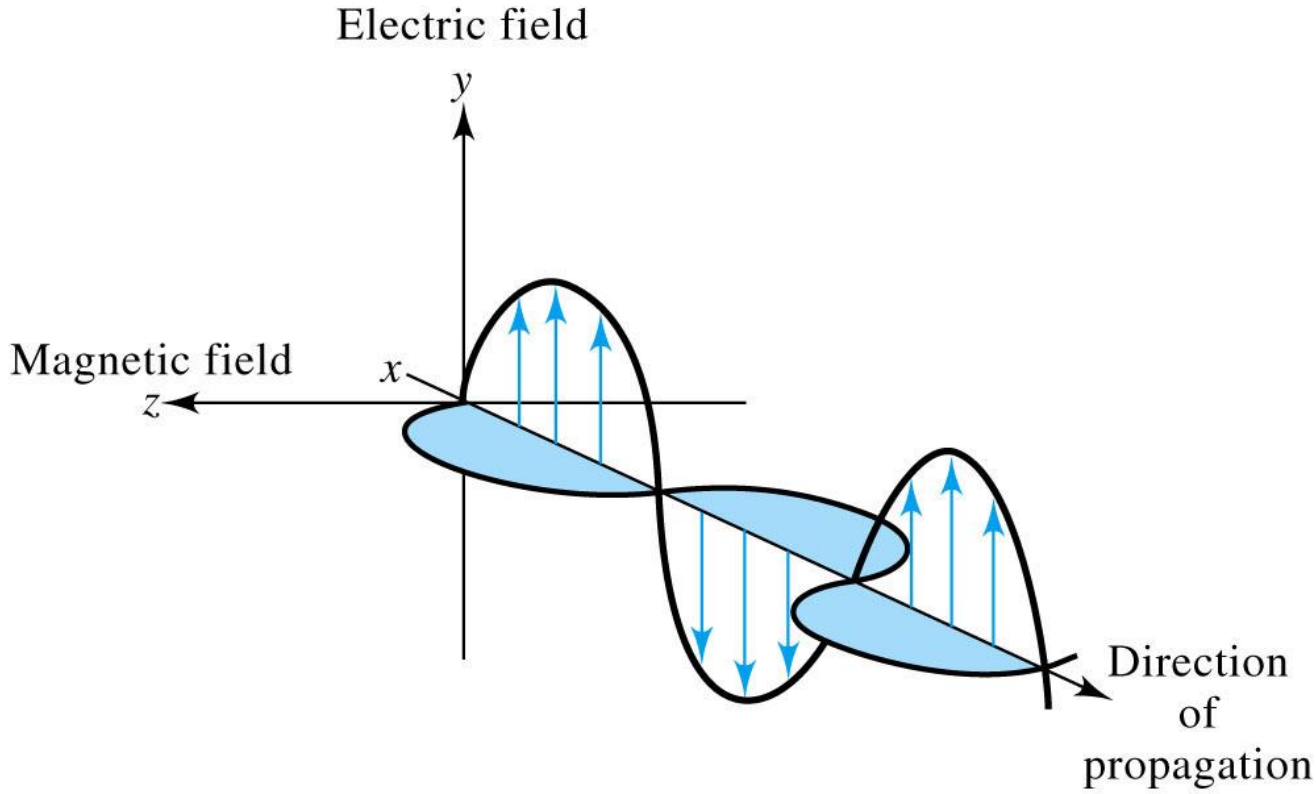

(a)

# Electric component of electromagnetic wave

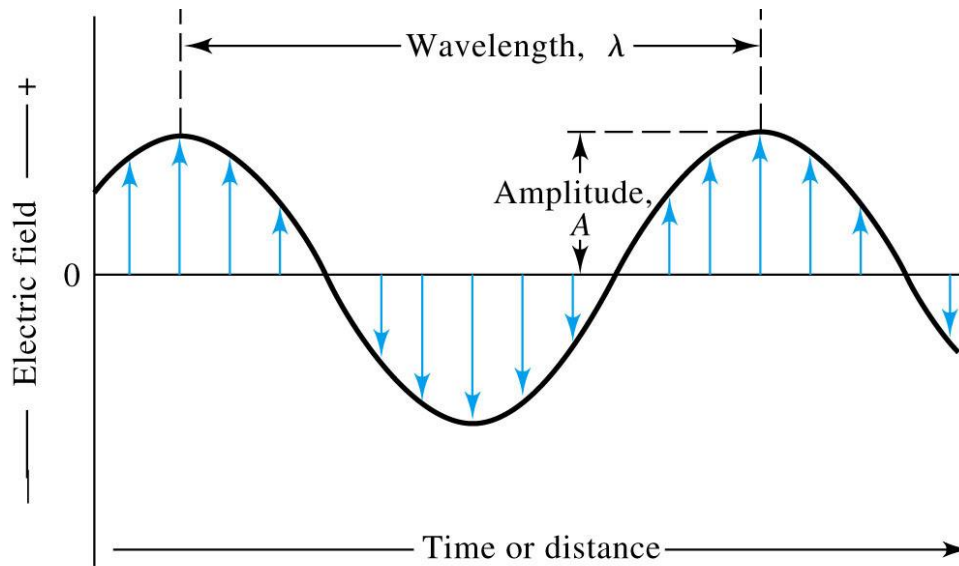

(b)

© 2007 Thomson Higher Education

$$v_i = v\lambda_i \quad (6-1)$$

Velocity of propagation  $v_i$

Frequency  $v$ : number of oscillations per second

In a vacuum,  $v_i$  is independent of wavelength and a maximum  
→  $c = 2.99792 \times 10^8$  m/s

In a air,  $v_i$  differs only slightly from  $c$  (about 0.03% less):  $\sim c$

$$c = v\lambda = 3.00 \times 10^8 \text{ m/s} = 3.00 \times 10^{10} \text{ cm/s} \quad (6-2)$$

Wavenumber  $\bar{v}$ : the reciprocal of wavelength in cm ( $\text{cm}^{-1}$ )

# The electromagnetic spectrum

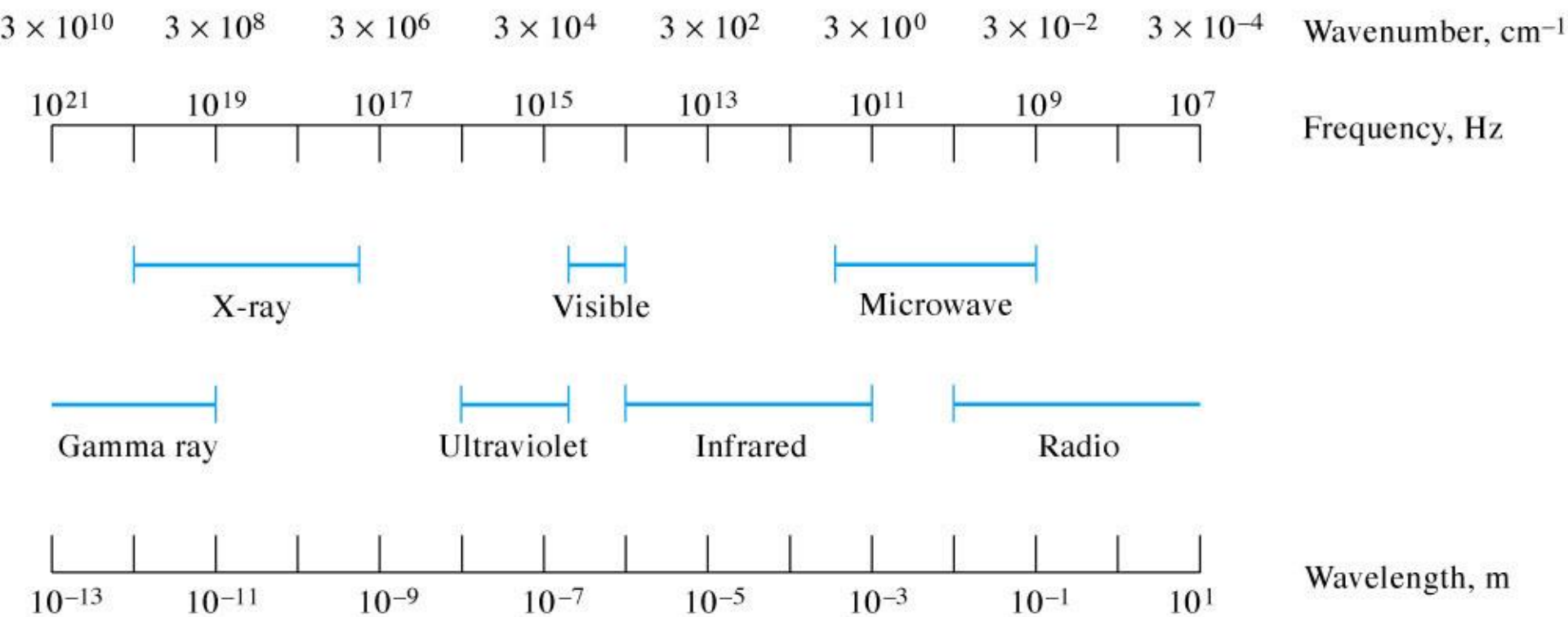

© 2007 Thomson Higher Education

*eV*

*nm*

*cm<sup>-1</sup>*

*Hz*

**TABLE 6-1** Common Spectroscopic Methods Based on Electromagnetic Radiation

Type of Spectroscopy	Usual Wavelength Range*	Usual Wavenumber Range, $\text{cm}^{-1}$	Type of Quantum Transition
Gamma-ray emission	0.005–1.4 Å	—	Nuclear
X-ray absorption, emission, fluorescence, and diffraction	0.1–100 Å	—	Inner electron
Vacuum ultraviolet absorption	10–180 nm	$1 \times 10^6$ to $5 \times 10^4$	Bonding electrons
Ultraviolet-visible absorption, emission, and fluorescence	180–780 nm	$5 \times 10^4$ to $1.3 \times 10^4$	Bonding electrons
Infrared absorption and Raman scattering	0.78–300 $\mu\text{m}$	$1.3 \times 10^4$ to $3.3 \times 10^1$	Rotation/vibration of molecules
Microwave absorption	0.75–375 mm	13–0.03	Rotation of molecules
Electron spin resonance	3 cm	0.33	Spin of electrons in a magnetic field
Nuclear magnetic resonance	0.6–10 m	$1.7 \times 10^{-2}$ to $1 \times 10^3$	Spin of nuclei in a magnetic field

# Energy states of chemical species

$$E_1 - E_0 = h\nu = \frac{hc}{\lambda} \quad (6-20)$$

Energy states:

Electronic states

Vibrational states

Rotational states

Ground state and excited states

**chemiluminescence**

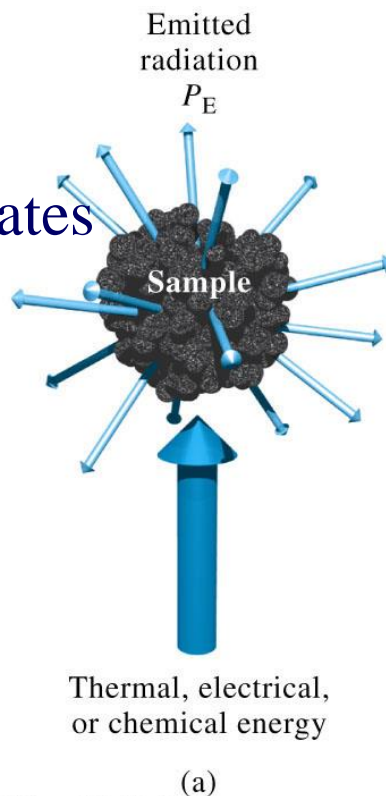

## *Emission*

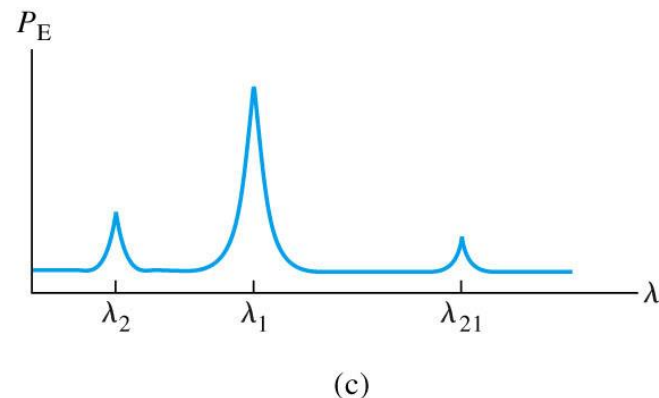
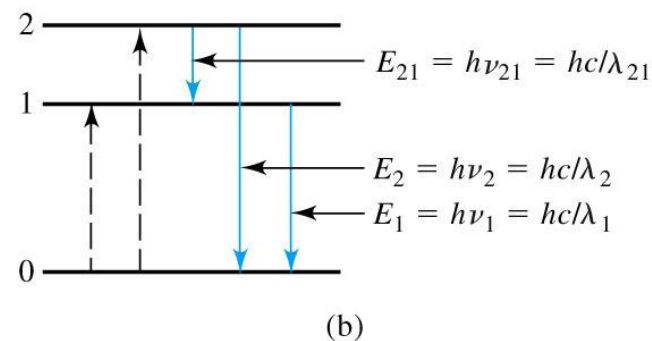

## Absorption

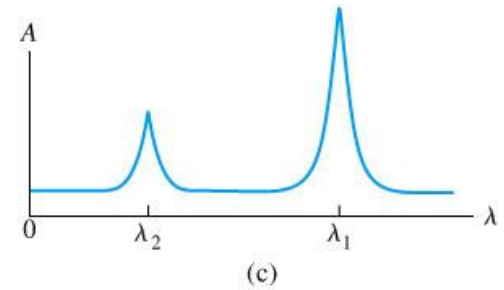
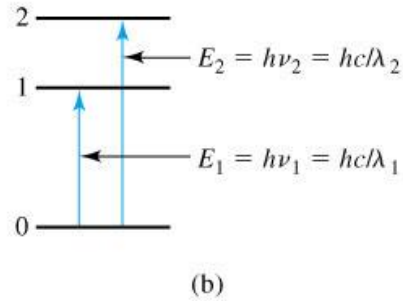
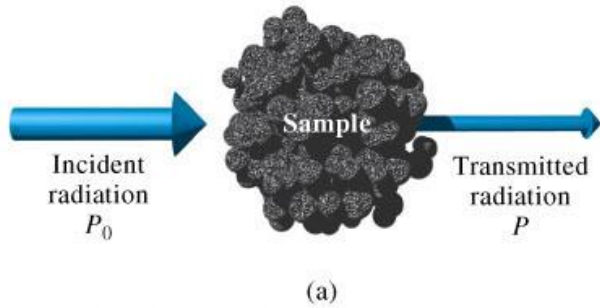

© 2007 Thomson Higher Education

## Luminescence

**Photoluminescence**  
(fluorescence (형광)  
and  
phosphorescence(인광))

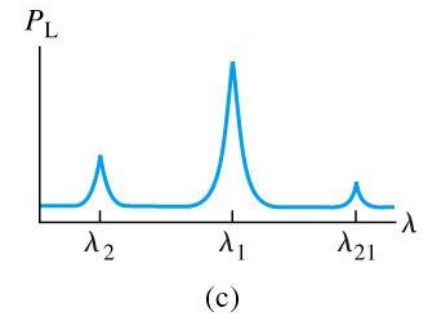
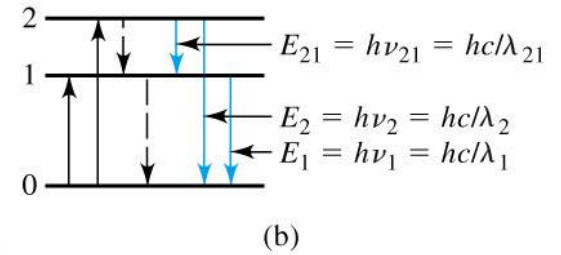
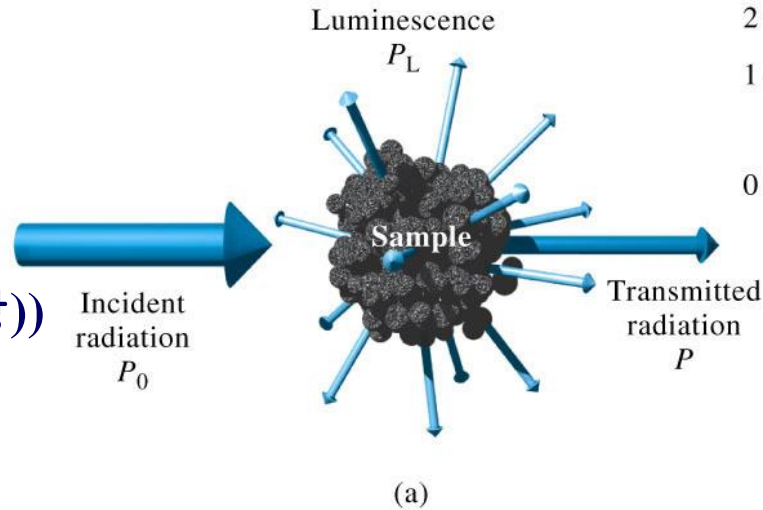

© 2007 Thomson Higher Education

# Quantitative aspects of spectrochemical measurements

Transmittance  $T$

Absorbance  $A$

Beer's law  $A = abc$ , where  $a$ : absorptivity ( $\text{Lg}^{-1}\text{cm}^{-1}$ ),  $b$ : path length through the medium (cm),  $c$ : concentration of absorbing species ( $\text{gL}^{-1}$ )

Or,  $A = \epsilon bc$ , where  $\epsilon$ : molar absorptivity ( $\text{Lmol}^{-1}\text{cm}^{-1}$ ),  $b$ (cm),  $c$ (mol/L)

*Beer's law*

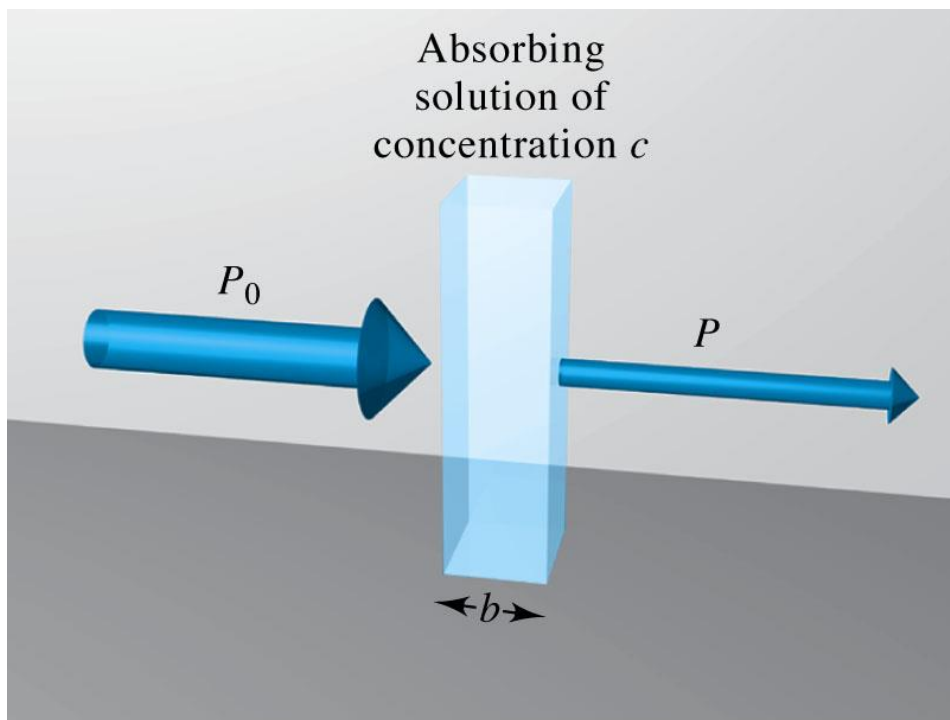

$$T = \frac{P}{P_0}$$
$$A = \log \frac{P_0}{P}$$



# 1. UV & visible spectroscopy

## (1) Transmission experiments

Simplest spectroelectrochemical experiment

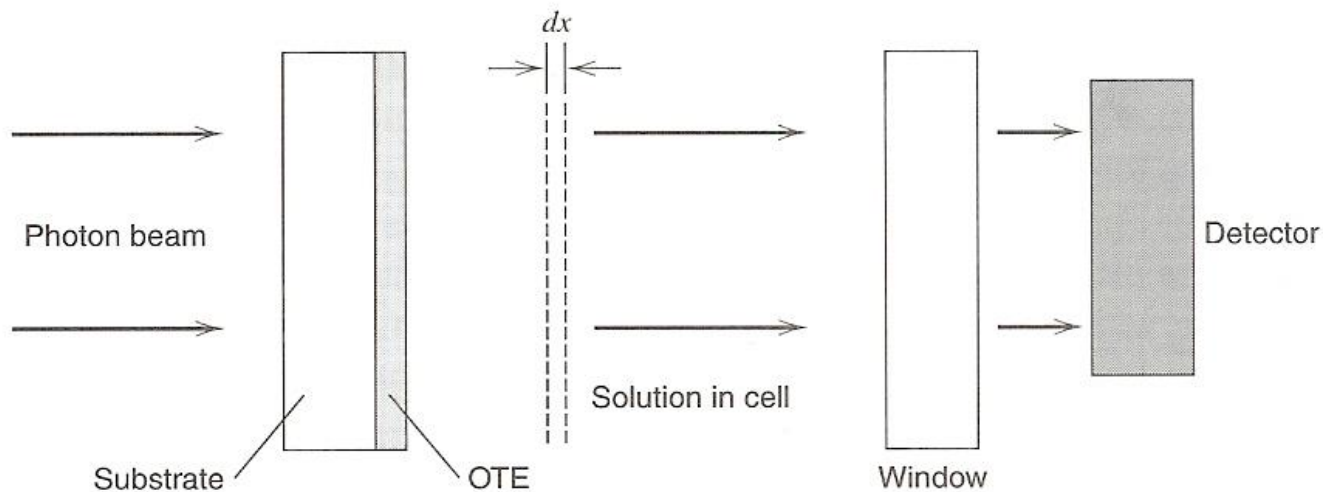

Absorbance change

Optically transparent electrode (OTE): ITO, Au or Pt on glass, minigrids

# Electrochemical cuvette

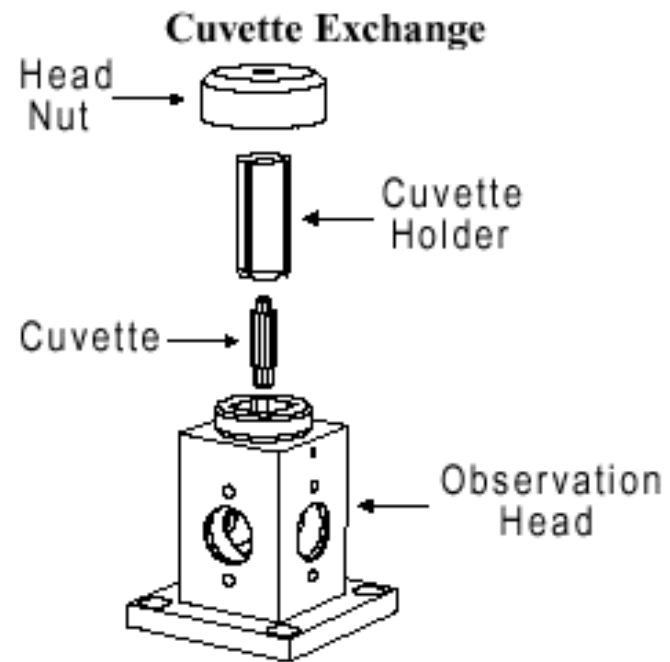

## Responses for transmission spectroelectrochemistry: absorbance vs. time

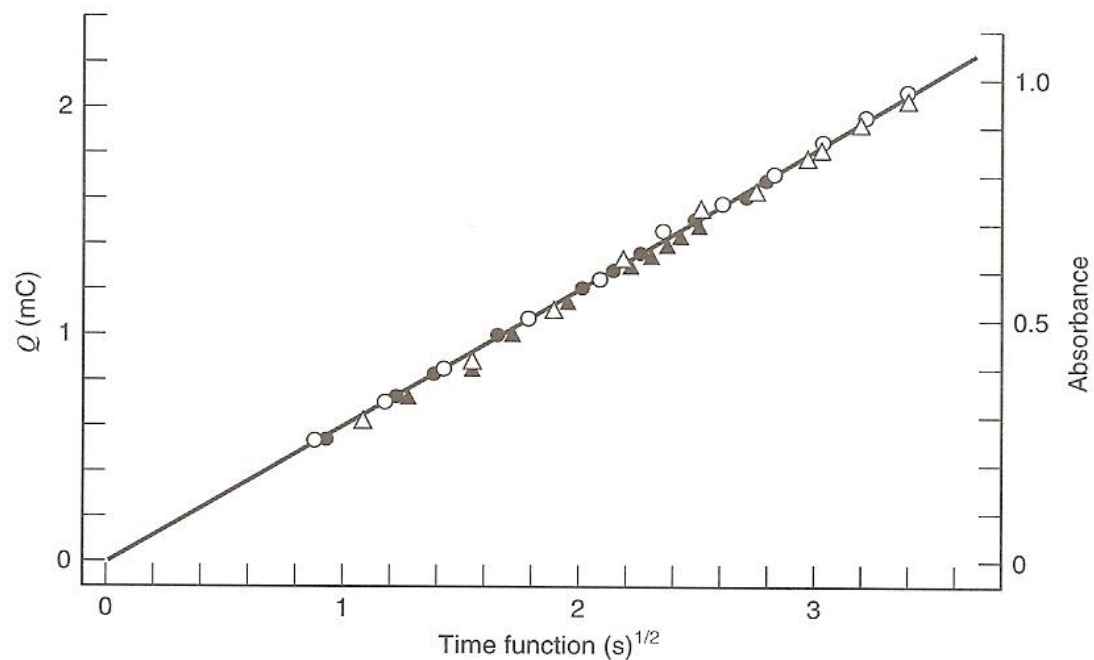

Oxidation of o-tolidine

# Spectra of cobalt complex at different potentials

Co(II) at -0.9 V and Co(I) at -1.45 V

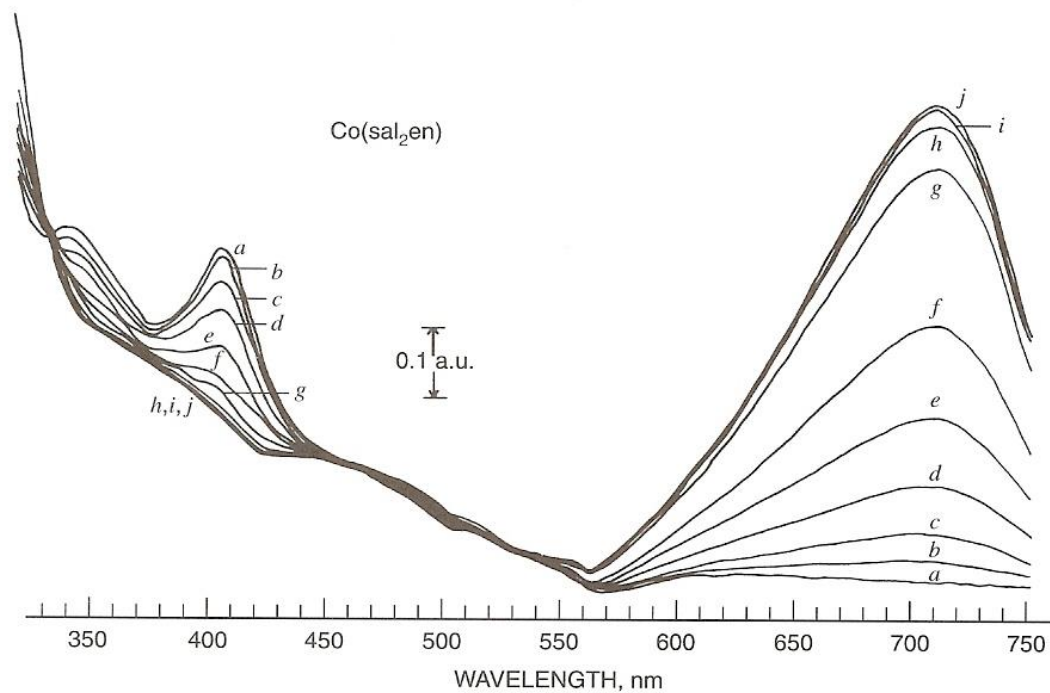

-0.90 V to -1.450 V  
from a to j

# Coulometric titration (reduction) of cytochrome c and oxidase By methyl viologem ( $MV^{2+}$ )

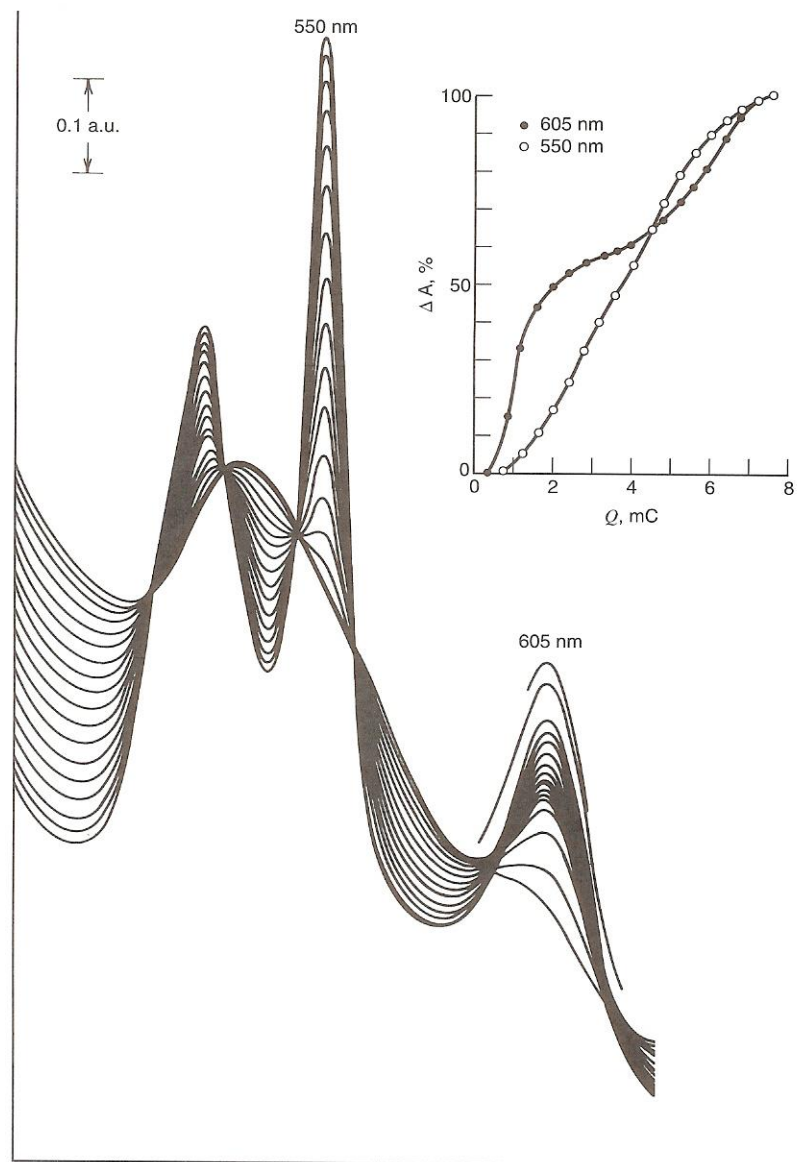

## ***In-situ* transmittance test**

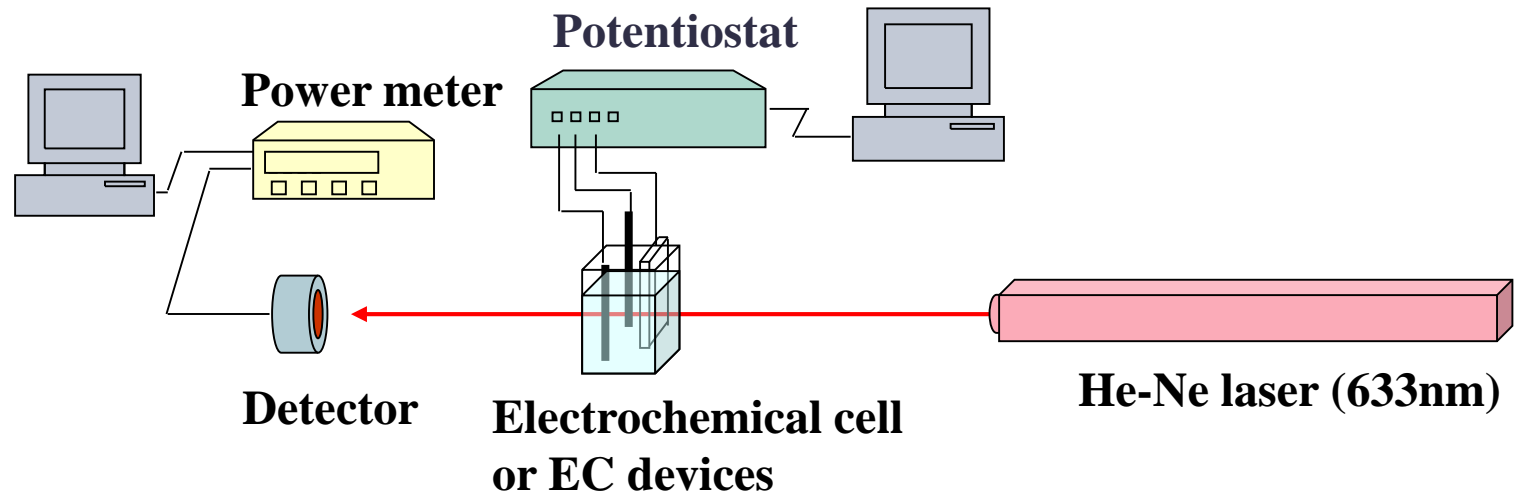

## (2) Ellipsometry

Change of electrode surface  $\rightarrow$  change of reflecting properties

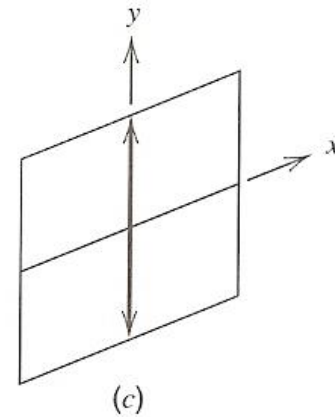
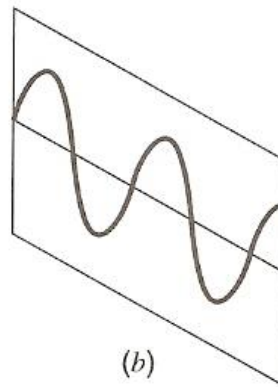
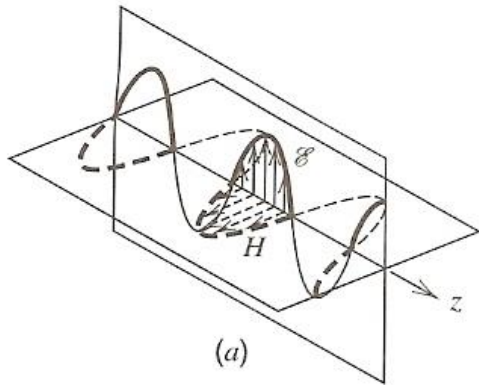

Polarization (편광)

# Polarization of radiation (편광)

Ordinary radiation consists of a bundle of electromagnetic waves in which the vibrations are equally distributed among a huge number of planes centered along the path of the beam

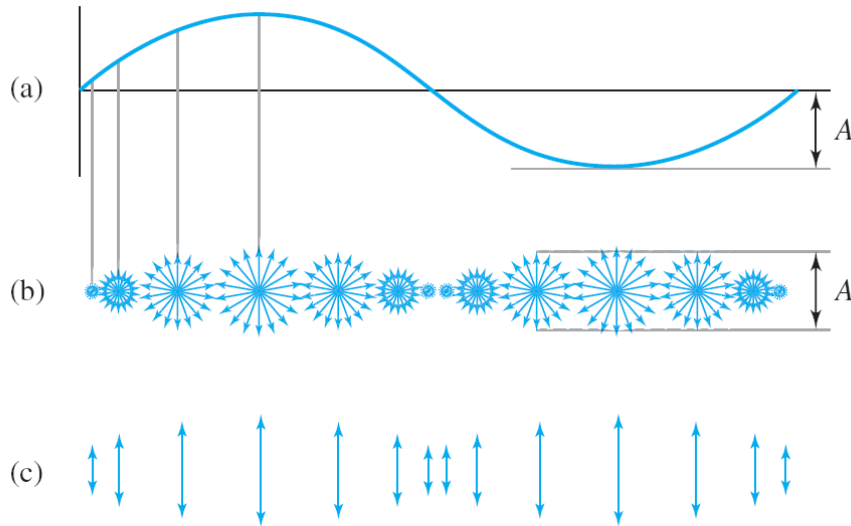

**그림 6-11** 비편광과 평면-편광복사선: (a) 단색복사선 빛살의 단면도, (b) (a)의 비편광복사선을 계속적으로 끝에서 볼 때의 단면도, 그리고 (c) 수직축으로 평면-편광된 (a) 복사선을 계속적으로 끝에서 볼 때의 단면도.

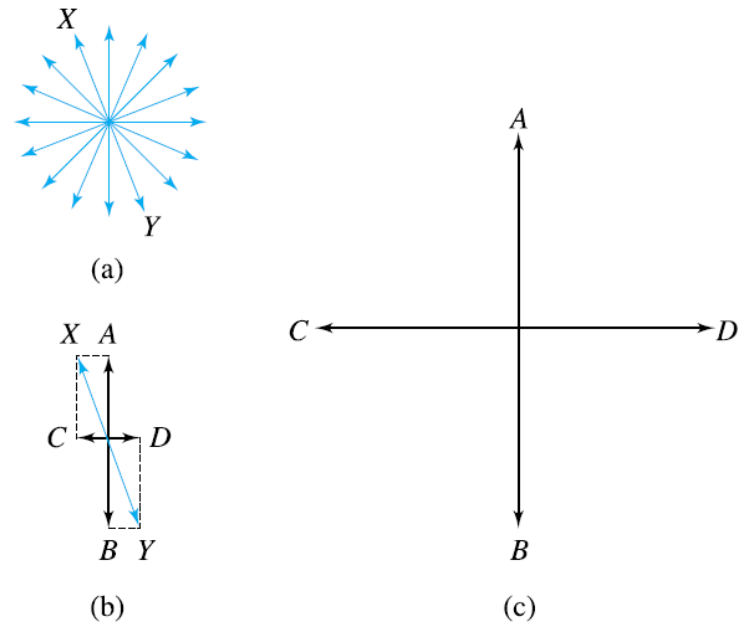

**그림 6-12** (a) 종이면에 수직으로 진행하는 빛살의 전기벡터 중의 몇 개, (b) 평면 XY의 벡터를 두 개의 수직되는 성분으로 분해, (c) 모든 벡터를 분해한 결과(척도는 맞지 않음).



# Transmission of radiation

Radiation through a transparent substance

Refractive index (굴절율) of a medium is one measure of its interaction with radiation

$$n_i = \frac{c}{v_i} \quad (6-11)$$

The velocity of the radiation in the medium ( $v_i$ )

Most liquid:  $n_i = 1.3 \sim 1.8$

Solid:  $1.3 \sim 2.5+$

Interaction  $\rightarrow$  polarization(분극, temporarily deformation ( $10^{-14} \sim 10^{-15}$  s) of atom & molecular species in medium

Interaction  $\rightarrow$  wavelength change  $\rightarrow$  variation of  $n_i$  with wavelength, “dispersion”(분산)

# Refraction of radiation (굴절)

Radiation passes at an angle through the interface between two transparent media that have different densities → refraction as a consequence of a difference in velocity of the radiation in two media.

$$\frac{\sin \theta_1}{\sin \theta_2} = \frac{n_2}{n_1} = \frac{v_2}{v_1}$$

(6-12) *Snell's Law*

If  $M_1$  is vacuum,  $v_1 = c$ ,  $n_1 = 1$

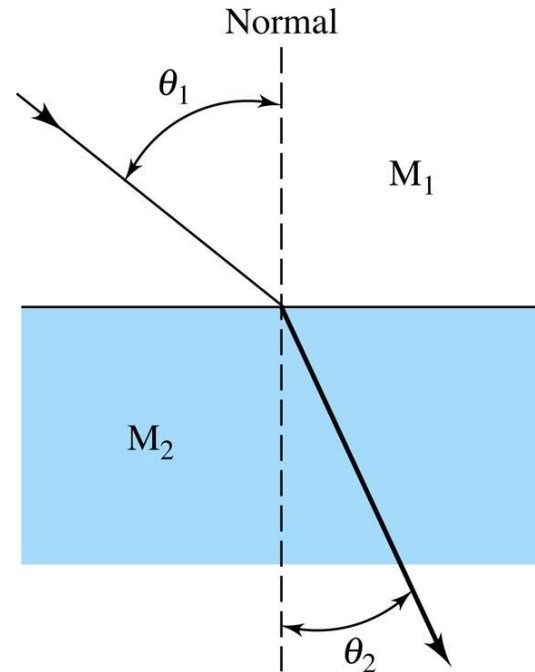

## Reflection of radiation (반사)

Radiation passes at an angle through the interface between two transparent media that have different densities → reflection always occurs

Fraction of reflection

$$\frac{I_r}{I_0} = \frac{(n_2 - n_1)^2}{(n_2 + n_1)^2} \quad (6-15)$$

$I_0$ : intensity of the incident beam,  $I_r$ : the reflected intensity

# Reflection

Four types:

Specular reflection: smooth surface

Diffuse reflection

Internal reflection

Attenuated total reflection (ATR)

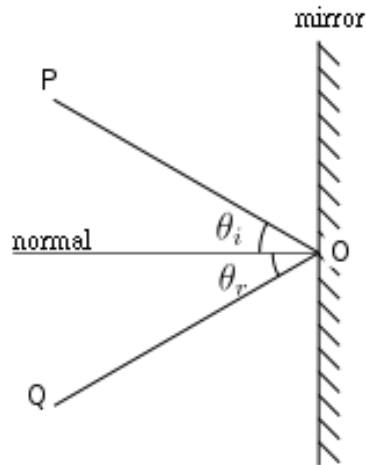

Specular reflection  
(정반사)

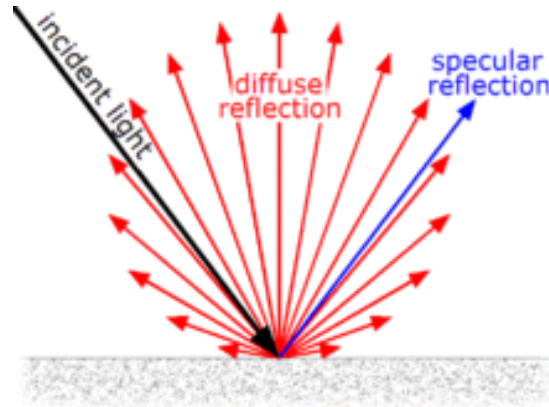

Diffuse reflection

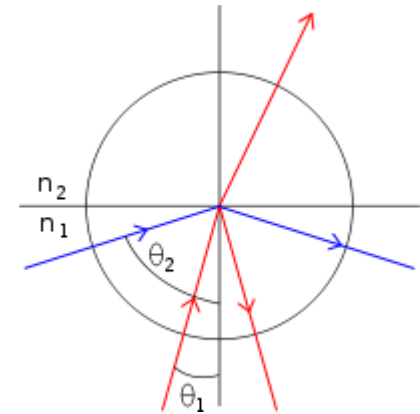

Internal reflection  
(blue line)

## Reflection of polarized light from a surface

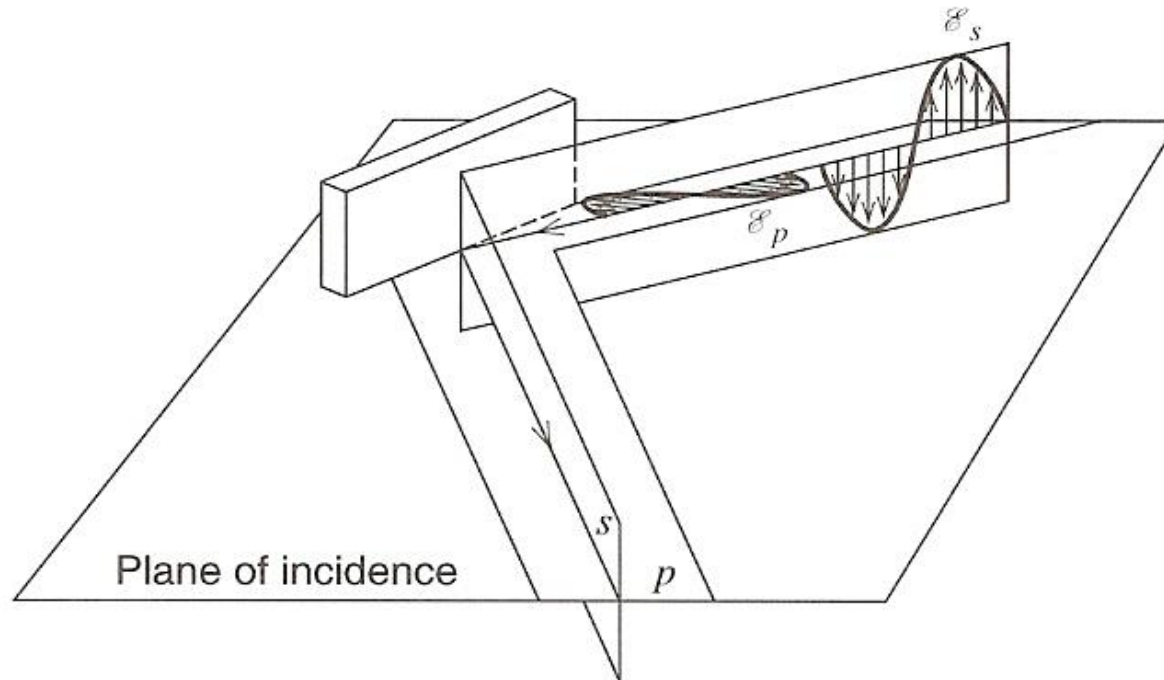

Parallel to incident plane: p

Perpendicular: s

Other angle: resolve p and s

If a linearly polarized beam is reflected from a surface, the parallel and perpendicular components undergo different changes in amplitude and phase

Pairs of rays  $\rightarrow$  elliptically polarized (circular polarization: equal amplitudes,  $90^\circ$  phase shift)

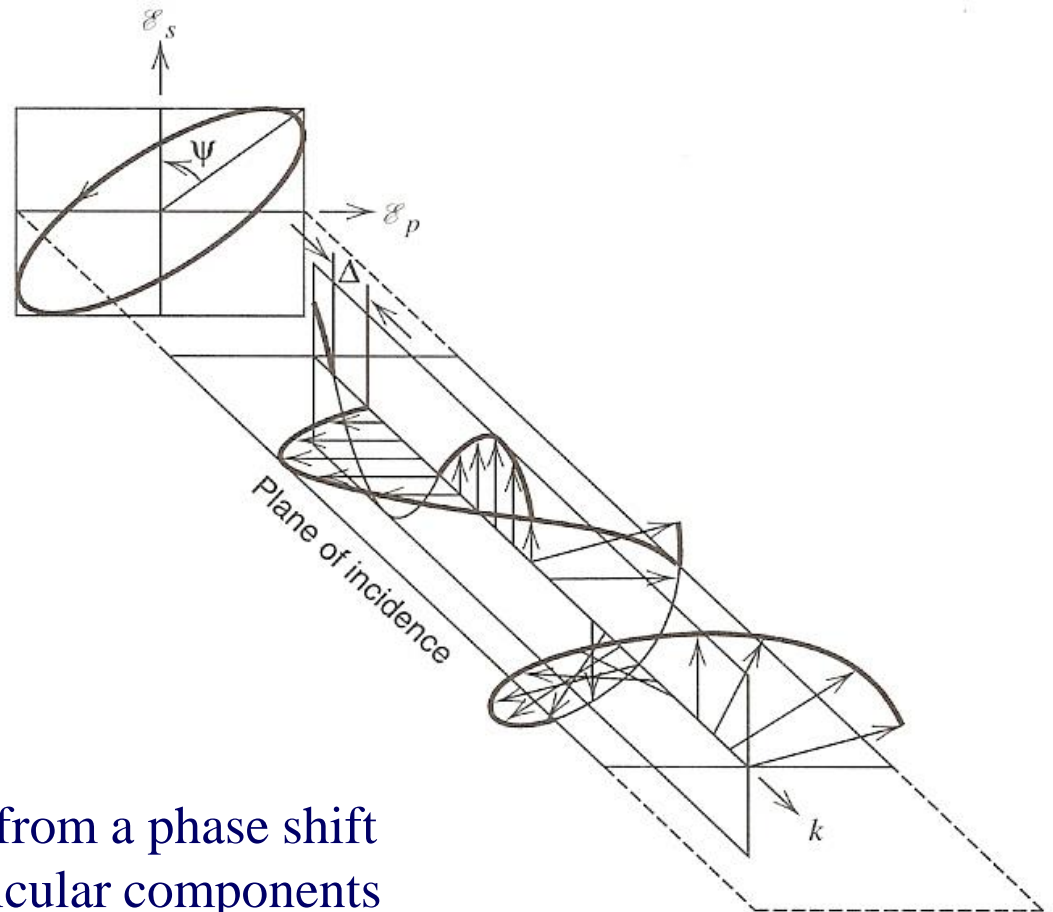

Elliptic polarization arising from a phase shift between parallel & perpendicular components

## Elliptical polarization:

In electrodynamics, **elliptical polarization** is the polarization of electromagnetic radiation such that the tip of the electric field vector describes an ellipse in any fixed plane intersecting, and normal to, the direction of propagation. An elliptically polarized wave may be resolved into two linearly polarized waves in phase quadrature, with their polarization planes at right angles to each other. Since the electric field can rotate clockwise or counterclockwise as it propagates, elliptically polarized waves exhibit chirality.

Other forms of polarization, such as circular and linear polarization, can be considered to be special cases of elliptical polarization.

(from Wikipedia)

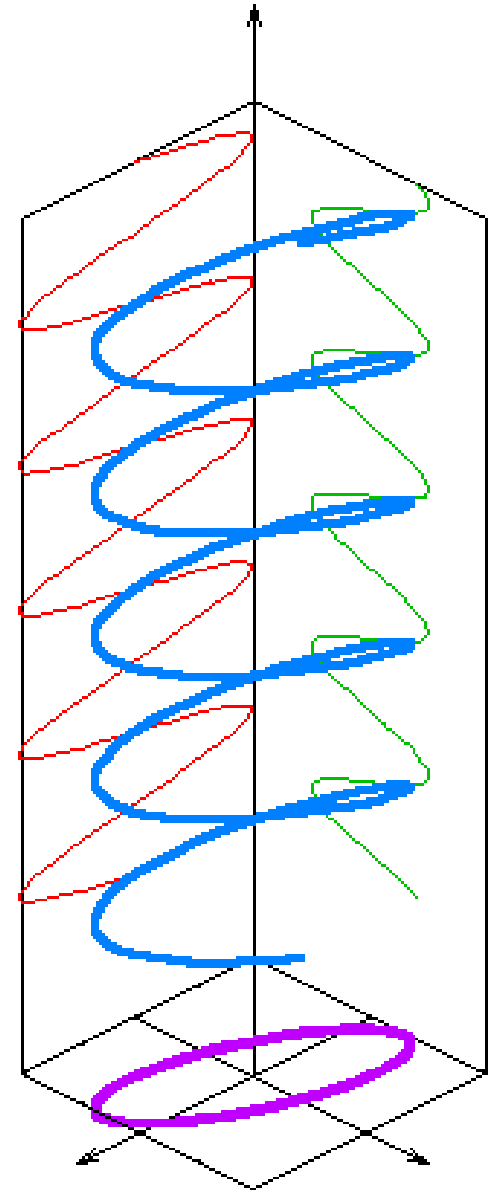

# Ellipsometry

Change of electrode surface  $\rightarrow$  change of reflecting properties

-Difference in phase angle:  $\Delta$

-Ratio of electric field amplitudes  $\Psi$

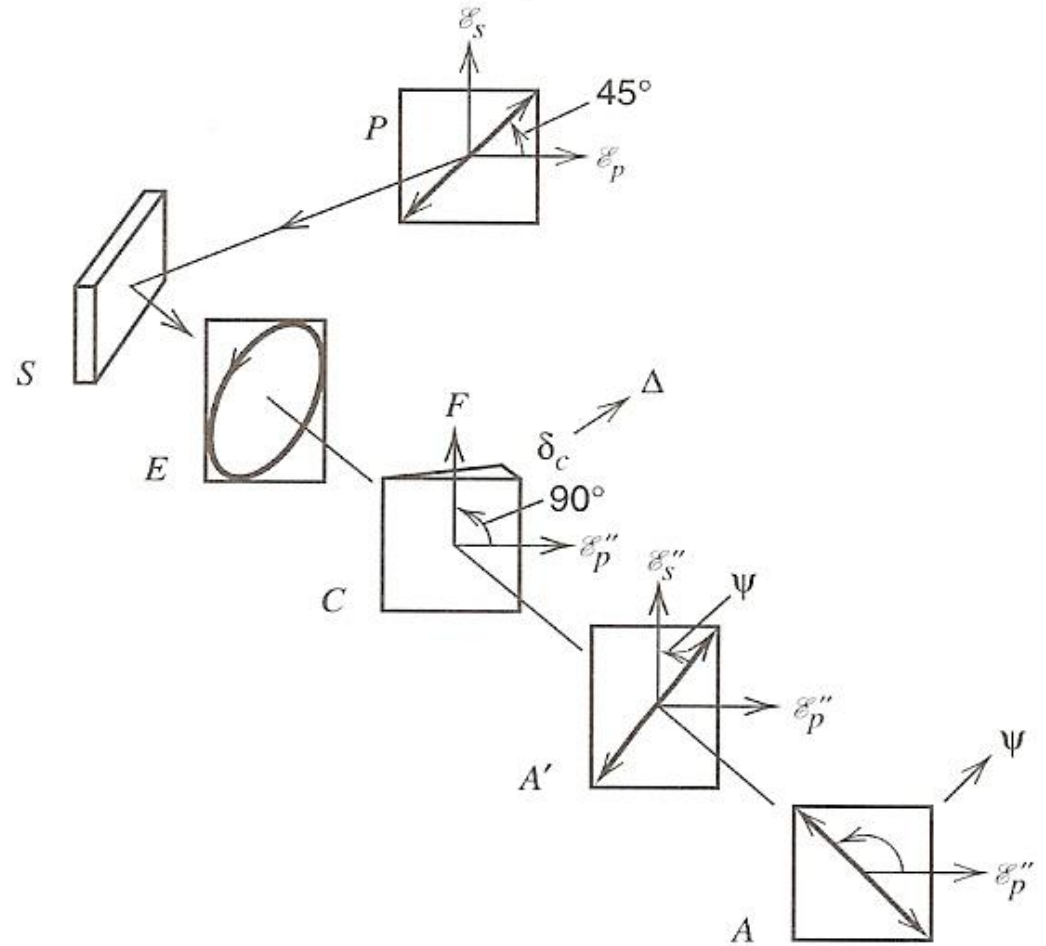



# Ellipsometric results for anodization of Al in tartaric acid

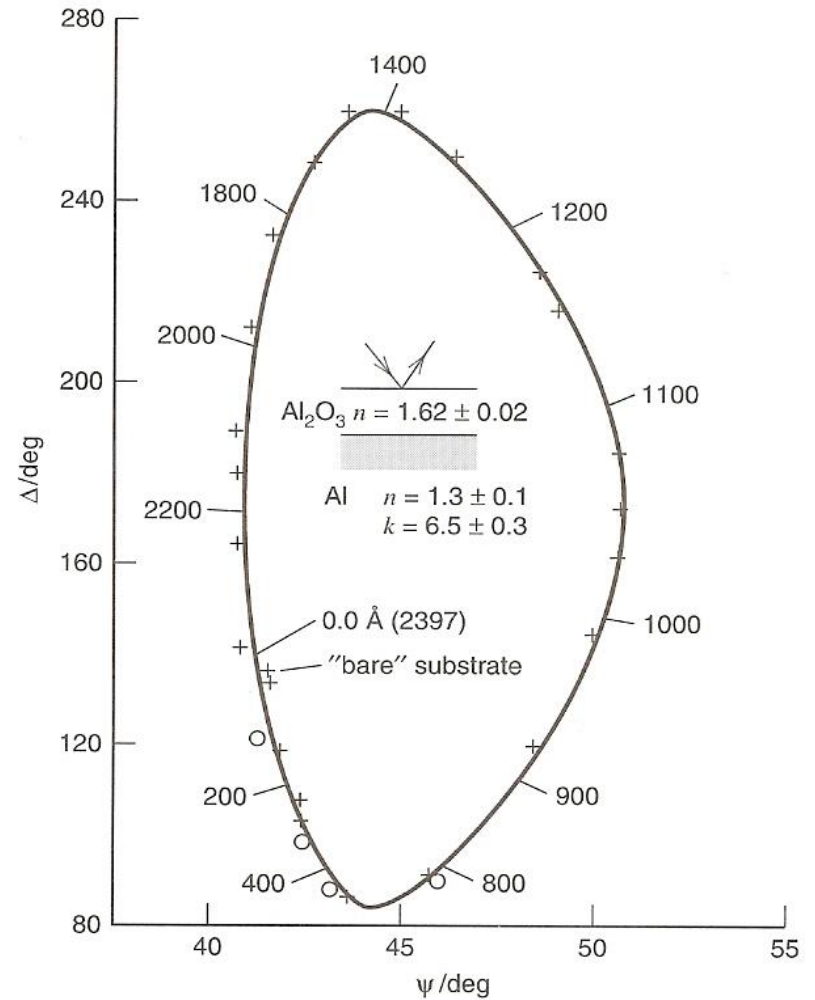

## Growth of passive film on Fe at 0.8 V vs. SCE

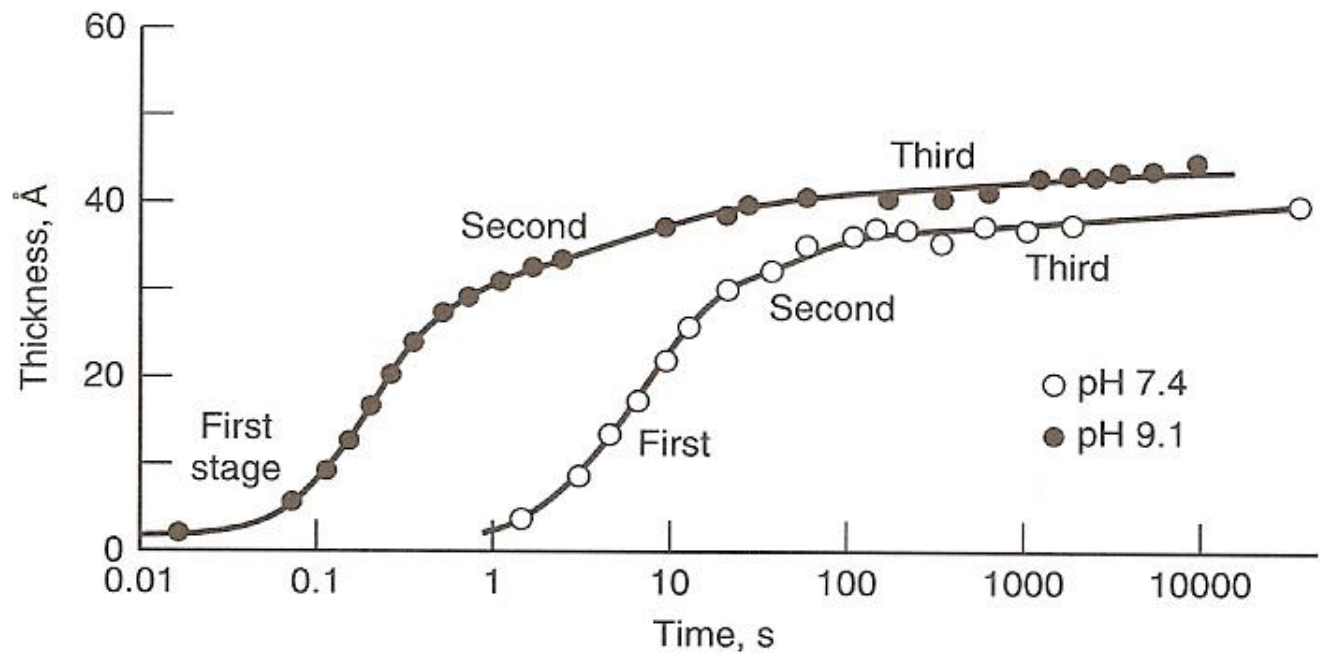

# Growth of polyaniline film: experiemental (dotted) vs. fiited resluts (solid)

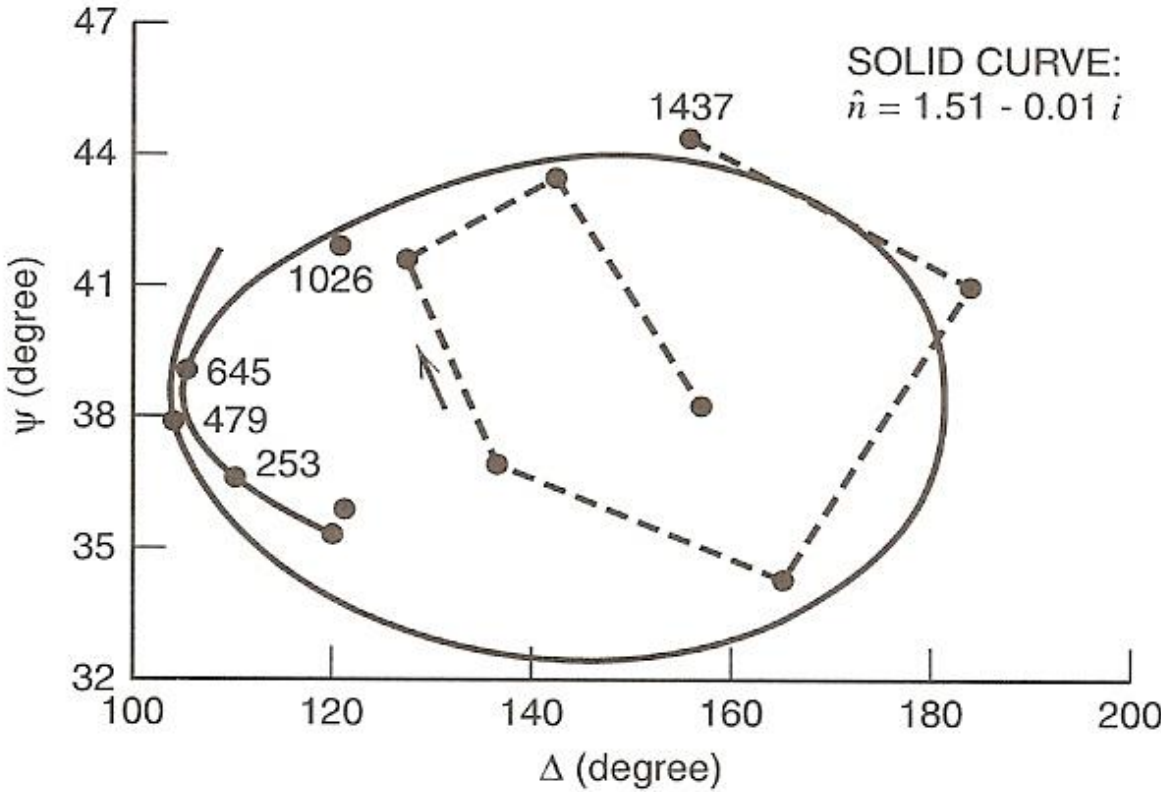

### (3) Internal reflection spectroelectrochemistry

Internal reflection  $\rightarrow$  light absorption by species at the interface

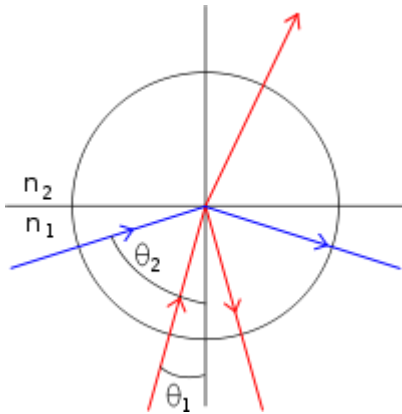

Internal reflection  
(blue line)

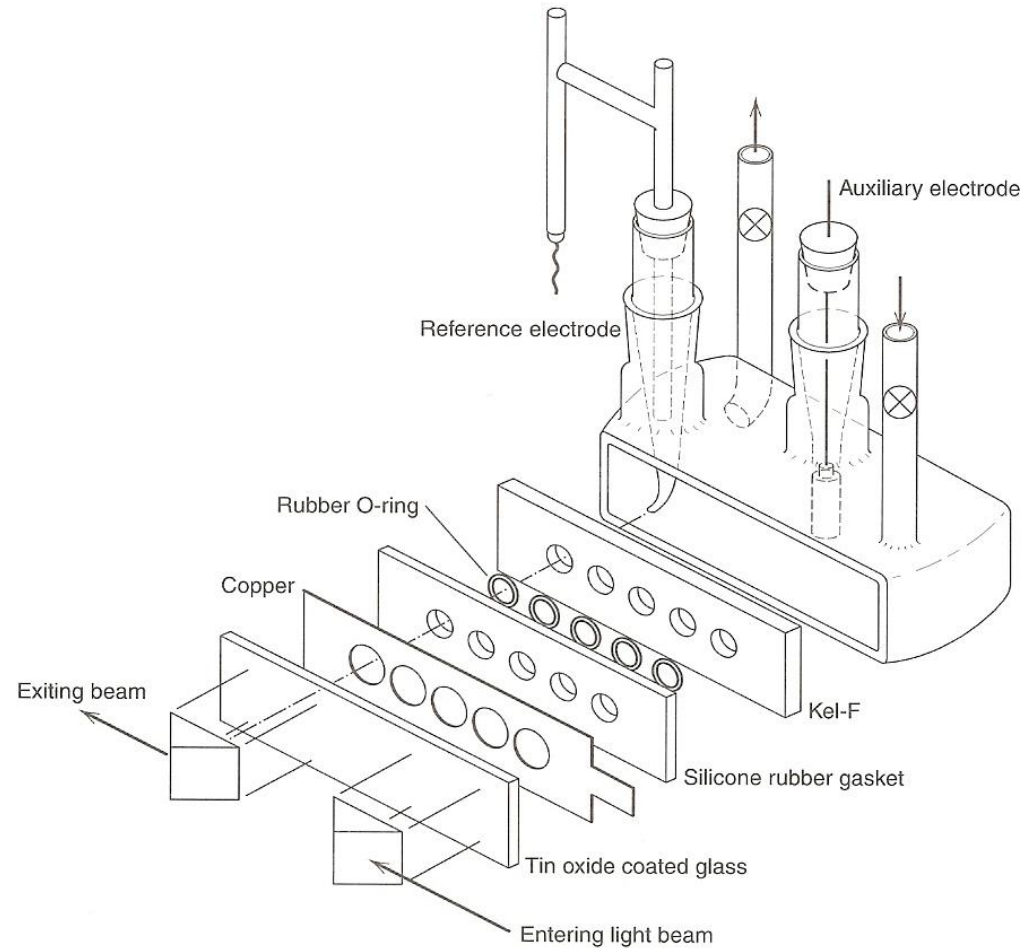

Cell assembly

# Surface plasmon resonance (SPR)

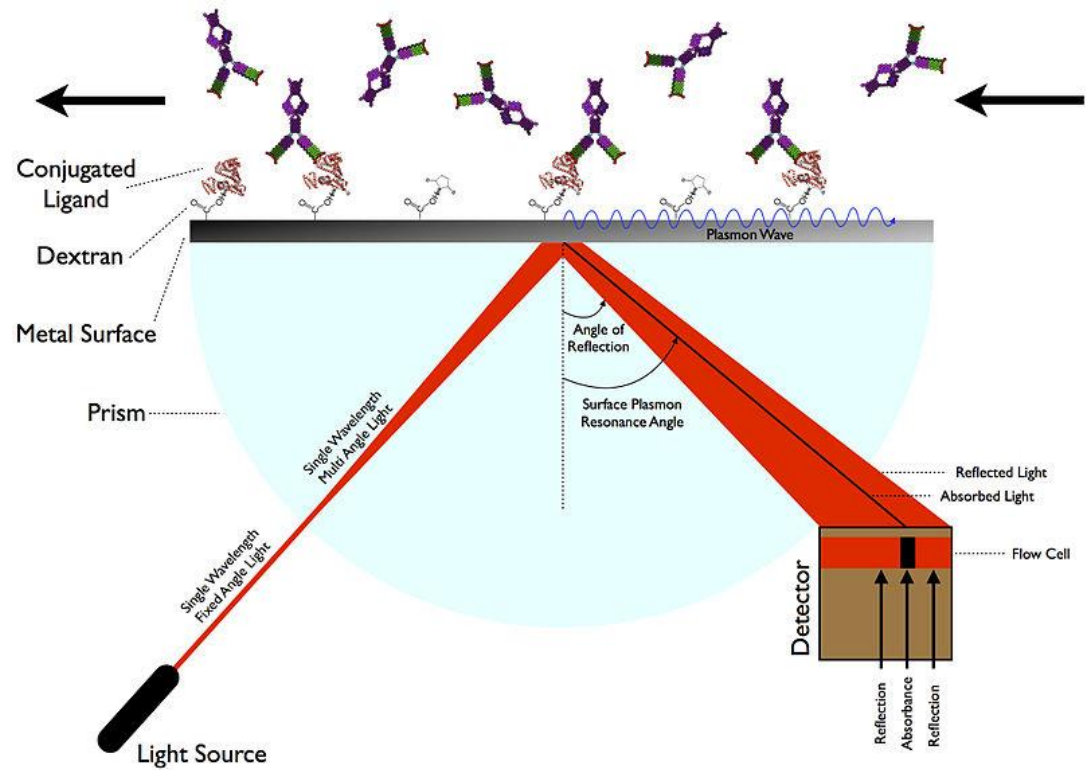

**Surface plasmon resonance (SPR)** is the collective oscillation of valence electron in a solid stimulated by incident light. The resonance condition is established when the frequency of light photons matches the natural frequency of surface electrons oscillating against the restoring force of positive nuclei. SPR in nanometer-sized structures is called **localized surface plasmon resonance**. SPR is the basis of many standard tools for measuring adsorption of material onto planar metal (typically gold and silver) surfaces or onto the surface of metal nanoparticles. It is the fundamental principle behind many color-based biosensor applications and different lab-on-a-chip sensors. (from Wikipedia)

## Surface plasmon resonance (SPR)

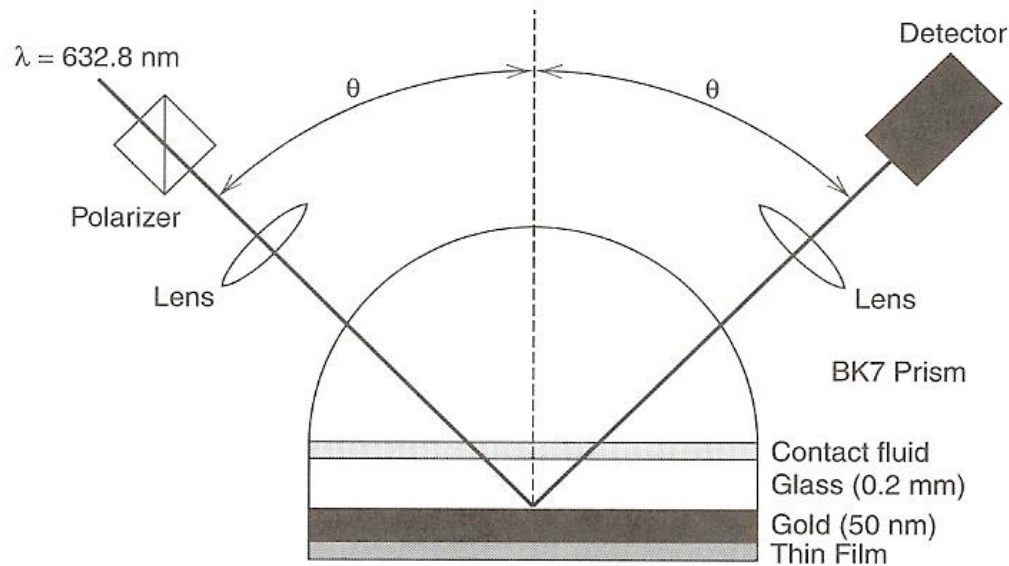

플라스몬(plasmon)이란 금속 내의 자유전자가 집단적으로 진동하는 유사 입자를 말한다. 금속의 나노 입자에서는 플라스몬이 표면에 국부적으로 존재하기 때문에 표면 플라스몬(surface plasmon)이라 부르기도 한다. 그 중에서도 금속 나노 입자에서는 가시~근적외선 대역 빛의 전기장과 플라스몬이 짝지어지면서 광흡수가 일어나 선명한 색을 띠게 된다. (이 경우, 플라스몬과 광자가 결합되어 생성하는 또다른 유사 입자를 플라즈마 폴라리톤이라고 한다.) 이 현상을 표면 플라스몬 공명(surface plasmon resonance)이라 하며, 국소적으로 매우 증가된 전기장을 발생시킨다. (위키백과)

# SPR curves for Au and adsorbed monolayers

The shift of SPR minimum  $\rightarrow$  change in interface: determine the thickness of the adsorbed layer

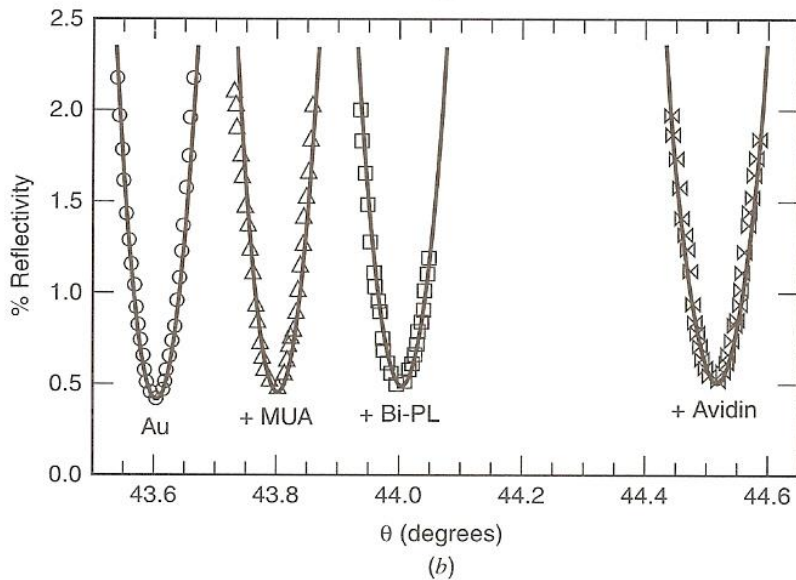
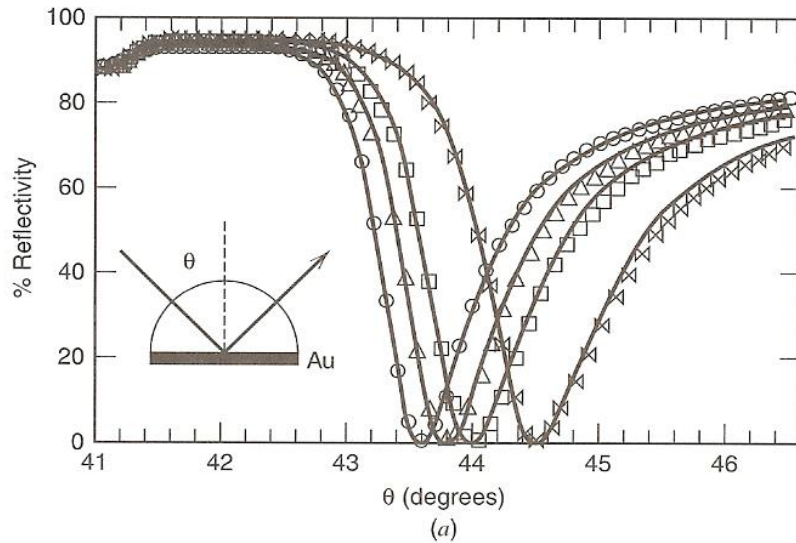

## (4) Second harmonic spectroscopy

Second harmonic generation (SHG):  $\omega \rightarrow 2\omega$

Second harmonic generation (SHG): noncentrosymmetric crystals

If symmetry is broken at the solid/liquid interface  $\rightarrow$  SHG signal

SHG signal is sensitive to species at the interface: used to detect adsorbed species, reaction intermediates etc

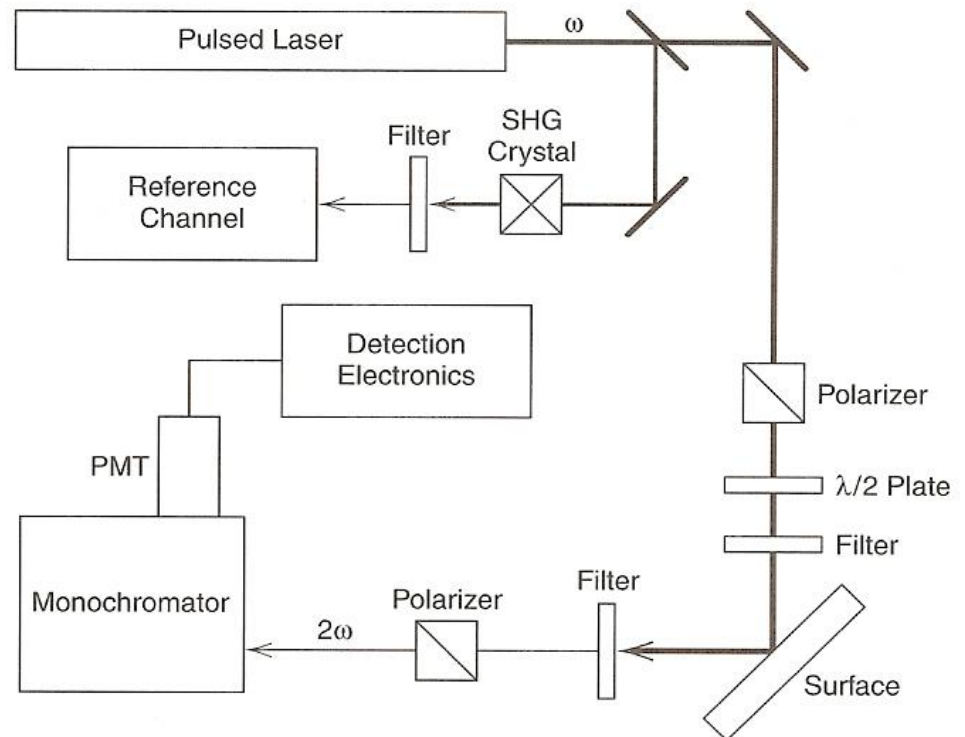



## Non-linear optical effects

Polarization (순간적 찌그러짐),  $P = \alpha E$

$\alpha$ : proportionality constant,  $E$ : electric field

At high radiation intensities (lasers)  $\rightarrow$  nonlinear optical effect

$$P = \alpha E + \beta E^2 + \gamma E^3 + \dots$$

where  $\alpha > \beta > \gamma$

약한 강도의 빛: 첫번째 항만 중요 (직선관계)

강한 강도의 빛 (레이저): 두번째, 세번째 항 중요

두 항만 고려하면,  $P = \alpha E_m \sin \omega t + \beta E_m^2 \sin^2 \omega t$   
 $\sin^2 \omega t = (1 - \cos 2\omega t)/2$ 를 이용하면,

$$P = \alpha E_m \sin \omega t + [\beta E_m^2 / 2](1 - \cos 2\omega t)$$

첫 항: 선형관계 (linear) (at low radiation intensities)

두번째 항: 비선형(non-linear), frequency가  $2\omega$ , 즉 입사 주파수의 두배(double)가 됨

$\rightarrow$  “frequency-doubling process”: 단파장 레이저 만드는데 많이 씀

Nd-YAG: 1064 nm IR  $\rightarrow$  532 nm green (30% yield, potassium dihydrogen phosphate(dielectric 물질)에 통과)  $\rightarrow$  266 nm UV (ammonium dihydrogen phosphate 통과)

# SHG response

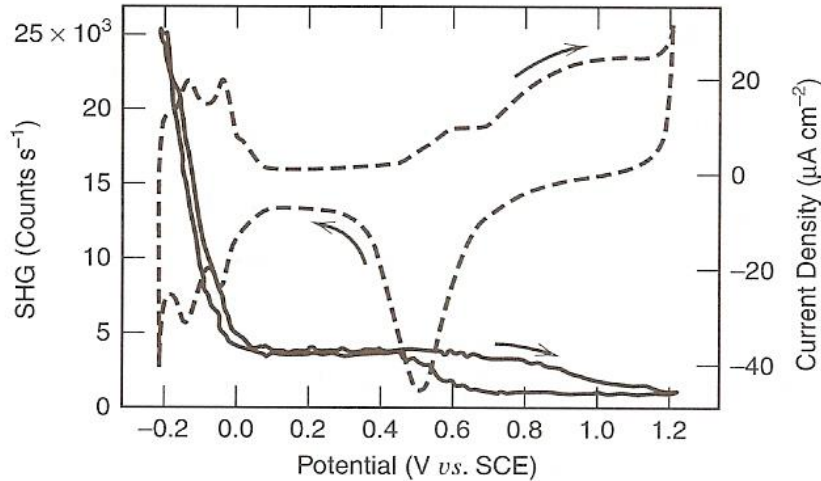

(a)

Polycrystalline Pt in HClO<sub>4</sub>/KCl  
CV vs. SHG signal

Neg. potential: adsorbed hydrogen  
0~0.4 V: adsorbed chloride ion  
>0.4 V: oxide or adsorbed hydroxyl

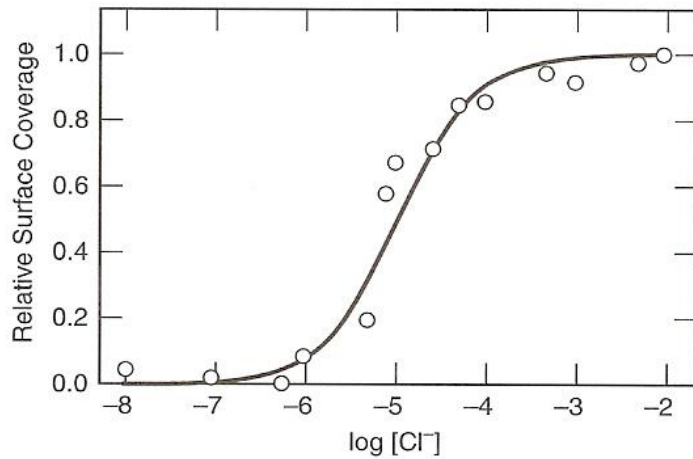

(b)

Adsorption isotherm at 0.2 V at  
different KCl  
concentration using SHG  
signal