

Lecture Note of Innovative Ship and Offshore Plant Design

Innovative Ship and Offshore Plant Design

Part I. Ship Design

Ch. 1 Introduction to Ship Design

Spring 2017

Myung-II Roh

Department of Naval Architecture and Ocean Engineering
Seoul National University

Innovative Ship and Offshore Plant Design, Spring 2017, Myung-II Roh



1

Contents

- Ch. 1 Introduction to Ship Design**
- Ch. 2 Design Equations**
- Ch. 3 Design Model**
- Ch. 4 Deadweight Carrier and Volume Carrier**
- Ch. 5 Freeboard Calculation**
- Ch. 6 Resistance Prediction**
- Ch. 7 Propeller and Main Engine Selection**
- Ch. 8 Hull Form Design**
- Ch. 9 General Arrangement (G/A) Design**
- Ch. 10 Structural Design**
- Ch. 11 Outfitting Design**

Innovative Ship and Offshore Plant Design, Spring 2017, Myung-II Roh



2

Ch. 1 Introduction to Ship Design

1. Basic Functions of a Ship
2. Main Terminology
3. Comparisons of a Ship with Other Structures
4. Construction Procedure of a Ship

1. Basic Functions of a Ship

Basic Requirements of a Ship

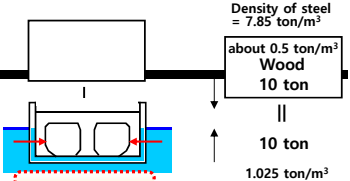

(1) Ship should float and be stable in sea water.

- ➔ Weight of the ship is equal to the buoyancy* in static equilibrium.

(2) Ship should transport cargoes.

- ➔ The inner space should be large enough for storing the cargoes.

(3) Ship should move fast to the destination and be possible to control itself.

- ➔ Shape: It should be made to keep low resistance (ex. streamlined shape).
- ➔ Propulsion equipment: Diesel engine, Helical propeller
- ➔ Steering equipment: Steering gear, Rudder

(4) Ship should be strong enough in all her life.

- ➔ It is made of the welded structure of steel plate (about 10~30mm thickness) and stiffeners.

* Archimedes' Principle: The buoyancy of the floating body is equal to the weight of displaced fluid of the immersed portion of the volume of the ship.

Ship stability

Ship compartment design

Hull form design, Ship hydrodynamics, Propeller design, Ship maneuverability and control

Ship structural mechanics, Structural design & analysis

Innovative Ship and Offshore Plant Design, Spring 2017, Myung-II Roh

sydlab 5

Basic Functions of a Ship

- Floating in the water**
 - Static equilibrium
- Containing like a strong bowl**
 - Welded structure of plates (thickness of about 20 ~ 30mm), stiffeners, and brackets
 - A VLCC has the lightweight of about 45,000 ton and can carry crude oil of about 300,000 ton.
- Going fast on the water**
 - Hull form: Streamlined shape having small resistance
 - Propulsion: Diesel engine, Helical propeller
 - The speed of ship is represented with knot(s). **1 knot** is a speed which can go **1 nautical mile (1,852 m) in 1 hour**.
 - A ship has less motion for being comfortable and safe of passengers and cargo.
 - Maneuvering equipment: Rudder

Innovative Ship and Offshore Plant Design, Spring 2017, Myung-II Roh

sydlab 6

How does a ship float? (1/3)

☑ The force that enables a ship to float ➡ " " " "

- It is
- It has a magnitude equal to
- which is

7

How does a ship float? (2/3)

☑ Archimedes' Principle

- The magnitude of the buoyant force acting on a floating body in the fluid is equal to the weight of the fluid which is displaced by the floating body.
- The direction of the buoyant force is opposite to the gravitational force.

Buoyant force of a floating body
= the weight of the fluid which is displaced by the floating body ("Displacement")
➡ Archimedes' Principle

☑ Equilibrium State ("Floating Condition")

- Buoyant force of the floating body = **Weight** of the floating body

∴ =

G: Center of gravity
B: Center of buoyancy
W: Weight, Δ: Displacement
ρ: Density of fluid
V: Submerged volume of the floating body (Displacement volume, ∇)

8

How does a ship float? (3/3)

(Δ) = Buoyant Force =

$$\Delta = L \cdot B \cdot T \cdot C_B \cdot \rho$$

$$= W = LWT + DWT$$

(W)

T: Draft
 C_B : Block coefficient
 ρ : Density of sea water
 LWT: Lightweight
 DWT: Deadweight

Weight = Ship weight (Lightweight) + **Cargo weight** (Deadweight)

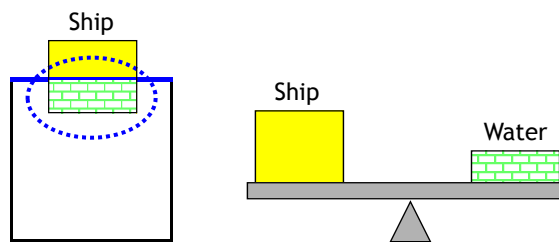

2. Main Terminology

Principal Dimensions (1/2)

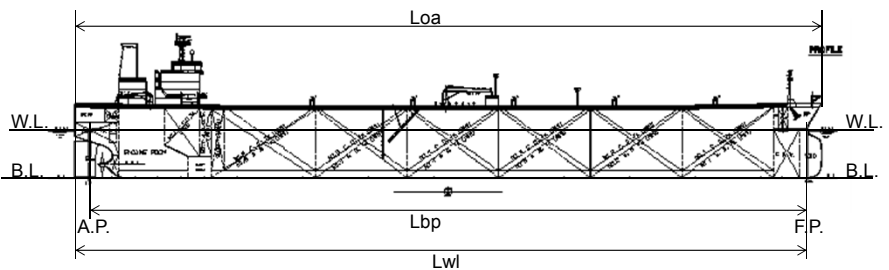

- ☑ LOA (Length Over All) [m]: Maximum Length of Ship

[m]

- A.P.: After perpendicular (normally, center line of the rudder stock)
- F.P.: Inter-section line between designed draft and fore side of the stem, which is perpendicular to the baseline

- ☑ Lf (Freeboard Length) [m]: Basis of freeboard assignment, damage stability calculation
 - 96% of Lwl at 0.85D or Lbp at 0.85D, whichever is greater
- ☑ Rule Length (Scantling Length) [m]: Basis of structural design and equipment selection
 - Intermediate one among (0.96 Lwl at Ts, 0.97 Lwl at Ts, Lbp at Ts)

sydlab 11
SEOUL NATION UNIVERSITY

Innovative Ship and Offshore Plant Design, Spring 2017, Myung-II Roh

Principal Dimensions (2/2)

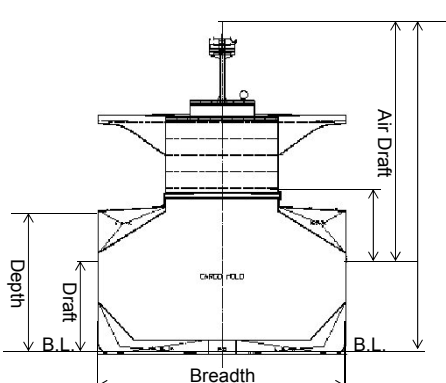

- B (Breadth) [m]: Maximum breadth of the ship, measured amidships
 - B_{molded}: excluding shell plate thickness
 - B_{extreme}: including shell plate thickness
- D (Depth) [m]: Distance from the baseline to the deck side line
 - D_{molded}: excluding keel plate thickness
 - D_{extreme}: including keel plate thickness
- Td (Designed Draft) [m]: Main operating draft
 - In general, basis of ship's deadweight and speed/power performance
- Ts (Scantling Draft) [m]: Basis of structural design

- Air Draft [m]: Distance (height above waterline only or including operating draft) restricted by the port facilities, navigating route, etc.
 - Air draft from baseline to the top of the mast
 - Air draft from waterline to the top of the mast
 - Air draft from waterline to the top of hatch cover
 - ...

sydlab 12
SEOUL NATION UNIVERSITY

Innovative Ship and Offshore Plant Design, Spring 2017, Myung-II Roh

What is a "Hull form"?

that is streamlined in order to satisfy requirements of a ship owner such as a deadweight, ship speed, and so on

- Like a skin of human
- ☑ Hull form design
 - Design task that designs the hull form

Hull form of the VLCC(Very Large Crude oil Carrier)

Wireframe model

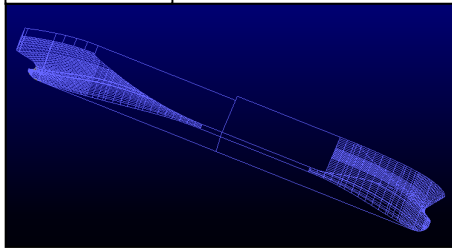

Surface model

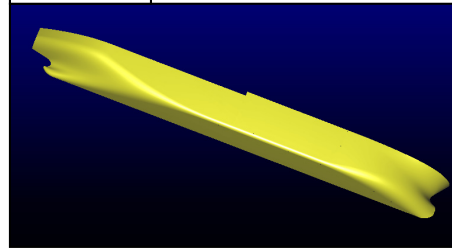

Lines of a 320K VLCC

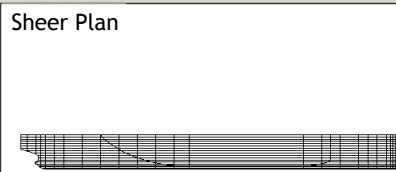
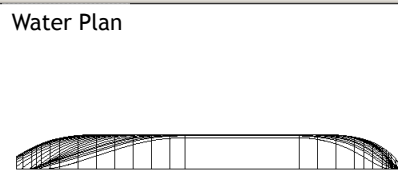
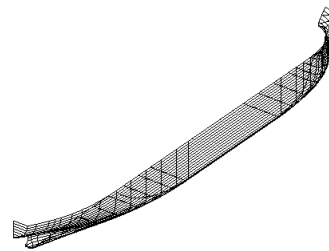
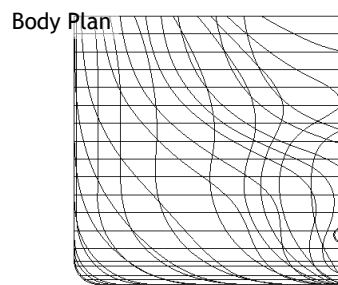

Hull Form Coefficients (1/2)

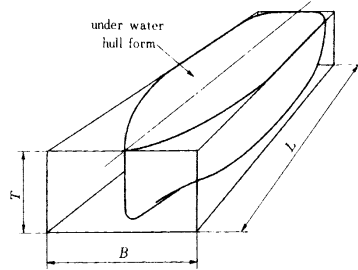

$$= \text{Displacement} / (L \times B \times T \times \text{Density})$$

where, density of sea water = 1.025 [Mg/m³]

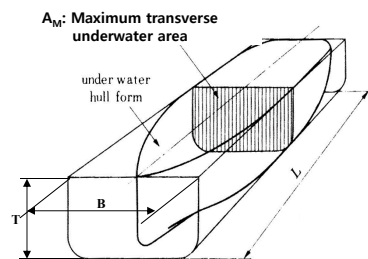

A_M : Maximum transverse underwater area

- C_M (Midship Section Coefficient)
= $A_M / (B \times T)$
- C_P (Prismatic Coefficient)
= $\text{Displacement} / (A_M \times L \times \text{Density})$

Hull Form Coefficients (2/2)

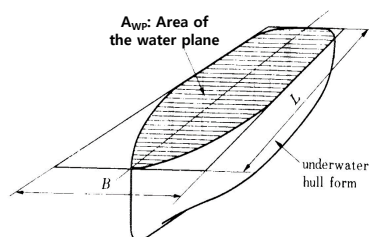

A_{WP} : Area of the water plane

- C_{WP} (Water Plane Area Coefficient)
= $A_{WP} / (L \times B)$

What is a "Compartment"?

- It is divided by a bulkhead which is a diaphragm or peritoneum of human.
- ☑ **Compartment design (General arrangement design)**
 - Compartment modeling + Ship calculation
- ☑ **Compartment modeling**
 - Design task that divides the interior parts of a hull form into a number of compartments
 - Design task that evaluates whether the ship satisfies the required cargo capacity by a ship owner and, at the same time, the international regulations **related to stability**, such as MARPOL and SOLAS, or not

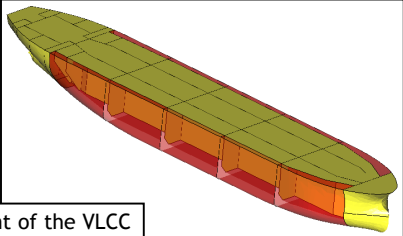

Compartment of the VLCC

17

G/A of a 320K VLCC

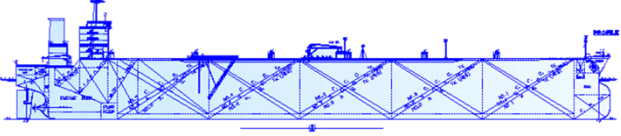
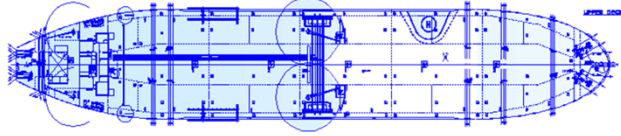
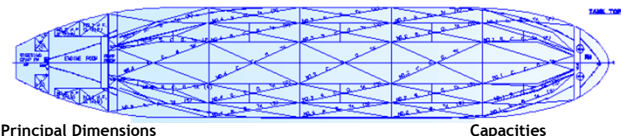
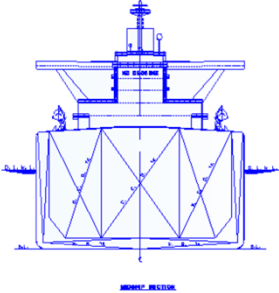
Principal Dimensions		Capacities	
LOA	332.0 m	Cargo tank	357,000 m ³
LBP	320.0 m	Water ballast	101,500 m ³
B	60.0 m		
D	30.5 m	Main Engine	SULZER 7RTA84T-D
Td / Ts	21.0 / 22.5 m	MCR	39,060 PS x 76.0 rpm
Deadweight at Ts	320,000 ton	NCR	35,150 PS x 73.4 rpm
Service speed at Td	16.0 knots	No. of cargo segregation	Three (3)
at NCR with 15% sea margin		Cruising range	26,500 N/M

* Reference: DSME
Innovative Ship and Offshore Plant Design, Spring 2017, Myung-Il Roh



18

What is a "Hull Structure"?

comprising of a number of hull structural parts such as plates, stiffeners, brackets, and so on

- Like a skeleton of human
- ☑ Hull structural design
 - Design task that determines the specifications of the hull structural parts such as the size, material, and so on

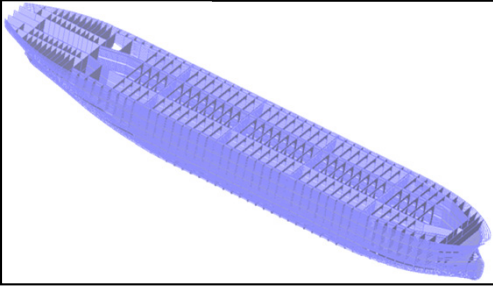
Hull structure of the VLCC



Innovative Ship and Offshore Plant Design, Spring 2017, Myung-II Roh

19

Structural Drawing of a 320K VLCC

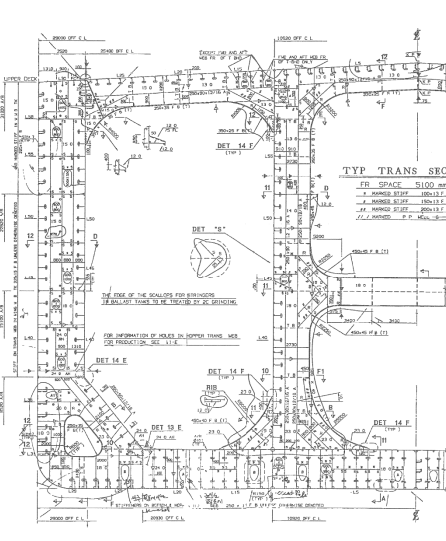

Web Frame Drawing

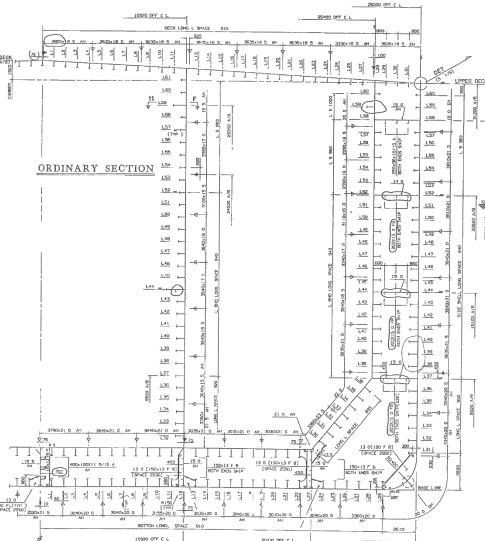

Midship Section (Ordinary Frame Section) Drawing

Innovative Ship and Offshore Plant Design, Spring 2017, Myung-II Roh

20

What is a "Outfitting"?

to be required for showing all function of the ship

- Hull outfitting: Propeller, rudder, anchor/mooring equipment, etc.
- Machinery outfitting: Equipment, pipes, ducts, etc. in the engine room
- Accommodation outfitting: Deck house (accommodation), voyage equipment, etc.
- Electric outfitting: Power, lighting, cables, and so on
- Like internal organs or blood vessels of human

☑ **Outfitting design**

- Design task that determines the types, numbers, and specifications of outfitting

Pipe model of the VLCC

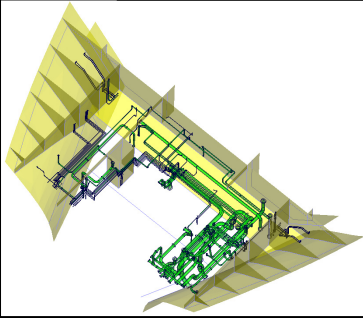

sydlab
21

Innovative Ship and Offshore Plant Design, Sorina 2017, Myung-II Roh

P&ID of a 320K VLCC

P&ID: Piping & Instrumentation Diagram, Non-scaled drawing representing the relationship between equipment

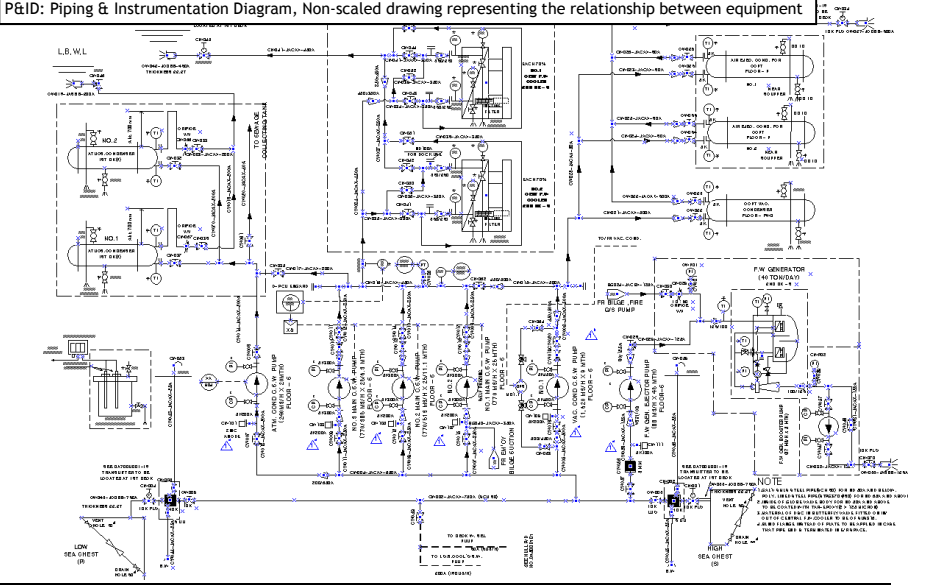

sydlab
22

Innovative Ship and Offshore Plant Design, Sorina 2017, Myung-II Roh

Criteria for the Size of a Ship

- Weight of water displaced by the ship's submerged part
- Equal to
- Used when representing the size of
 - Δ (DWT) [ton]: Actually, Cargo payload + Consumables (F.O., D.O., L.O., F.W., etc.) + DWT Constant
 - Used when representing the size of Δ (tanker, bulk carrier, ore carrier, etc.)
- Total volume of ship
- Basis for statics, tax, etc.
- Used when representing the size of

* F.O.: Fuel Oil, D.O.: Diesel Oil, L.O.: Lubricating Oil, F.W.: Fresh Water
 Innovative Ship and Offshore Plant Design, Spring 2017, Myung-II Roh

sydlab 23
SEOUL, KATA, UINIU

Weight and COG (Center Of Gravity)

- Weight of water displaced by the ship's submerged part [ton]
- Δ (DWT) [ton]: Cargo payload + Consumables (F.O., D.O., L.O., F.W., etc.) + DWT Constant = Displacement - Lightweight
- ☑ Cargo Payload [ton]: Weight of loaded cargo at the loaded draft
- ☑ DWT Constant [ton]: Operational liquid in the machinery and pipes, provisions for crew, etc.
- (LWT) [ton]: Total of hull steel weight and weight of equipment on board
- ☑ Trim: difference between draft at A.P. and F.P.
 - Trim = {Displacement x (LCB - LCG)} / (MTC x 100)
- ☑ LCB: Longitudinal Center of Buoyancy
- ☑ LCG: Longitudinal Center of Gravity

* F.O.: Fuel Oil, D.O.: Diesel Oil, L.O.: Lubricating Oil, F.W.: Fresh Water
 Innovative Ship and Offshore Plant Design, Spring 2017, Myung-II Roh

sydlab 24
SEOUL, KATA, UINIU

Tonnage

- ☑ **Tonnage: normally,**
 - **Basis of various fee and tax**
: Total sum of the volumes of every enclosed space
 - **NT (Net Tonnage): Total sum of the volumes of every cargo space**
 - GT and NT should be calculated in accordance with "IMO 1969 Tonnage Measurement Regulation".
 - **CGT (Compensated Gross Tonnage)**
 - **Panama and Suez canal have their own tonnage regulations.**

 25

Innovative Ship and Offshore Plant Design, Spring 2017, Myung-II Roh

[Reference] Old Conversion Factor between GT and CGT

船種 \ 船型 (DWT)	100-4,000	4,000-10,000	10,000-30,000	30,000-50,000	50,000-80,000	80,000-160,000	160,000-250,000	250,000 이상	비 고	
Crude oil carrier	1.70	1.15	0.75	0.60	0.50	0.40	0.30	0.25	Single hull tanker	
	1.85	1.30	0.85	0.70	0.55	0.45	0.35	0.30	Double hull tanker	
Product carriers & Chemical carriers	2.30		1.60	1.05	0.80	0.60	0.55		Black product carrier	
									White product carrier	
Bulk C+arriers	1.60	1.10	0.70	0.60	0.50	0.40	0.30		Chip carrier, Lumber Carrier, Car/bulk, Bulk/container, Open bulk	
Combined carriers	1.60	1.10	0.90	0.75	0.60	0.50	0.40		Ore/bulk/oil	
General Cargo Ships	1.85	1.35	1.00	0.75	0.60	0.50	0.40		Semi-container, Multi-purpose cargo	
Reefers	2.05	1.50	1.25							
Full container ships	1.85	1.20	10,000-20,000	20,000-30,000	0.75	0.65				
			0.90	0.80						
Ro-Ro vessels	1.50	1.05	0.80	0.70	0.65					
Car carriers	1.10	0.75	0.65	0.55	0.45				Ro-Ro/Container	
L.P.G. carriers	2.05	1.60	1.15	0.90	0.80	0.70				
L.N.G. carriers	2.05	1.60	1.25	1.15	1.00	0.75				

船種 \ 船型 (GT)	100-1,000	1,000-3,000	3,000-10,000	10,000-20,000	20,000-40,000	40,000-60,000	60,000 이상	비 고	
Ferries	3.00	2.25	1.65	1.15	0.90				
Passenger ships	6.00	4.00	3.00	2.00	1.60	1.40	1.25		
Fishing vessels	4.00	3.00	2.00						Fishing vessel & Fish factory ship
Other non-cargo vessels	5.00	3.20	2.00	1.50					Tug & Supply vessel, Dredger, Ice breaker, Cable layer, Research ship, etc

註 : 100GT 이상 선박

 26

Innovative Ship and Offshore Plant Design, Spring 2017, Myung-II Roh

[Reference] New Conversion Factor between GT and CGT

- ☑ Previous method was based on CGT coefficients, depending on type and deadweight of ships.
- ☑ New method is based on formula.
- ☑ Instead of deadweight as base for the choice of the coefficients, the method is based on gross tonnage.

$$CGT = A \cdot GT^B$$

where,
 GT: Declared gross tonnage of the ship
 A: Factor representing the influence of ship type
 B: Factor representing the influence of ship size

Ship Type	A	B
Oil Tanker (D/H)	48	0.57
Chemical Tankers	84	0.55
Bulk Carriers	29	0.61
Combined Carriers	33	0.62
General Cargo	27	0.64
Reefers	27	0.68
Full Container	19	0.68
RO-RO Vessels	32	0.63
Car Carriers	15	0.70
LPG Carriers	62	0.57
LNG Carriers	32	0.68
Ferries	20	0.71
Passenger Ships	49	0.67
Fishing Ships	24	0.71
NCCV	46	0.62

* Clarksons, Universal Ship Measurement, 2011
 Innovative Ship and Offshore Plant Design, Spring 2017, Myung-II Roh

sydlab 27
SEOUL, HANU, ULSAN

Speed and Power (1/2)

- ☑ **MCR (Maximum Continuous Rating) [PS x rpm]**
 - NMCR (Nominal MCR)
 - DMCR (Derated MCR) / SMCR (Selected MCR)

[PS x rpm]

- ☑ **Trial Power [PS x rpm]: Required power without sea margin at the service speed (BHP)**

[%]: Power reserve for the influence of storm seas and wind including the effects of fouling and corrosion.

[knots]: Speed at NCR power with the specific sea margin (e.g., 15%)

Innovative Ship and Offshore Plant Design, Spring 2017, Myung-II Roh

sydlab 28
SEOUL, HANU, ULSAN

Speed and Power (2/2)

- DHP: Delivered Horse Power**
 - Power actually delivered to the propeller with some power loss in the stern tube bearing and in any shaft tunnel bearings between the stern tube and the site of the torsion-meter
- EHP: Effective Horse Power**
 - Required power to maintain intended speed of the ship
- η_D : Quasi-propulsive coefficient = EHP / DHP
- RPM margin**
 - To provide a sufficient torque reserve whenever full power must be attained under unfavorable weather conditions
 - To compensate for the expected future drop in revolutions for constant-power operation

Unit (1/2)

- LT (Long Ton, British) = 1.016 [ton], ST (Short Ton, American) = 0.907 [ton], MT (Metric Ton, Standard) = 1.0 [ton]
- Density** \rightarrow [ton/m³ or Mg/m³]
 - e.g., [ton/m³], density of steel = 7.8 [ton/m³], density of fresh water = 1.0 [ton/m³]
- 1 [knots] = 1 [NM/hr] = 1.852 [km/hr] =
- 1 [PS] = 75 [kgf·m/s] = 75×10^{-3} [Mg]·9.81 [m/s²]·[m/s]
 - = (Pferdestärke, German translation of horsepower)
 - NMCR of B&W6S60MC: 12,240 [kW] = 16,680 [PS]
- 1 [BHP] = 76 [kgf·m/s] = 76×10^{-3} [Mg]·9.81 [m/s²]·[m/s]
 - = (British horsepower)

Unit (2/2)

- SG (Specific Gravity) ➔ No dimension**
 - SG of material = density of material / density of water
 - e.g., SG of sea water = 1.025, SG of fresh water = 1.0, SG of steel = 7.8

- SF (Stowage Factor) ➔ [ft³/LT]**
 - e.g., SF = 15 [ft³/LT] ➔ SG = 2.4 [ton/m³]

- API (American Petroleum Institute) = (141.5 / SG) - 131.5**
 - e.g., API 40 ➔ SG = 0.8251

- 1 [barrel] =**
 - e.g., 1 [mil. barrels] = 159,000 [m³]

3. Comparisons of a Ship with Other Structures

Features of a Ship

Comparison with Other Structures (Building, Automobile, Airplane)

- Objective: vs. living
- Moving or fixed: vs. fixed
- External force acting on the structure: vs. wind force, frictional force, etc.
- Design concept: vs. one design
- Production method: vs. mass production

Hull Form Design vs. Car Exterior Design

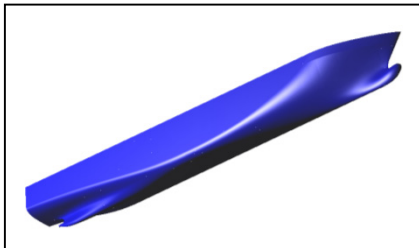

- Hull form design
 - A hull form is related to **the resistance and propulsion performance** of a ship.
 - Order production: new design for each order
 - Large structure of about 100~400 m length
 - **The performance like speed and deadweight is most important.**



- Car exterior design
 - A exterior is related to **the air resistance and esthetic design** of a car.
 - Mass production: one time design for each model
 - Small structure of about 3~5 m length
 - **The performance and esthetic design are simultaneously important.**

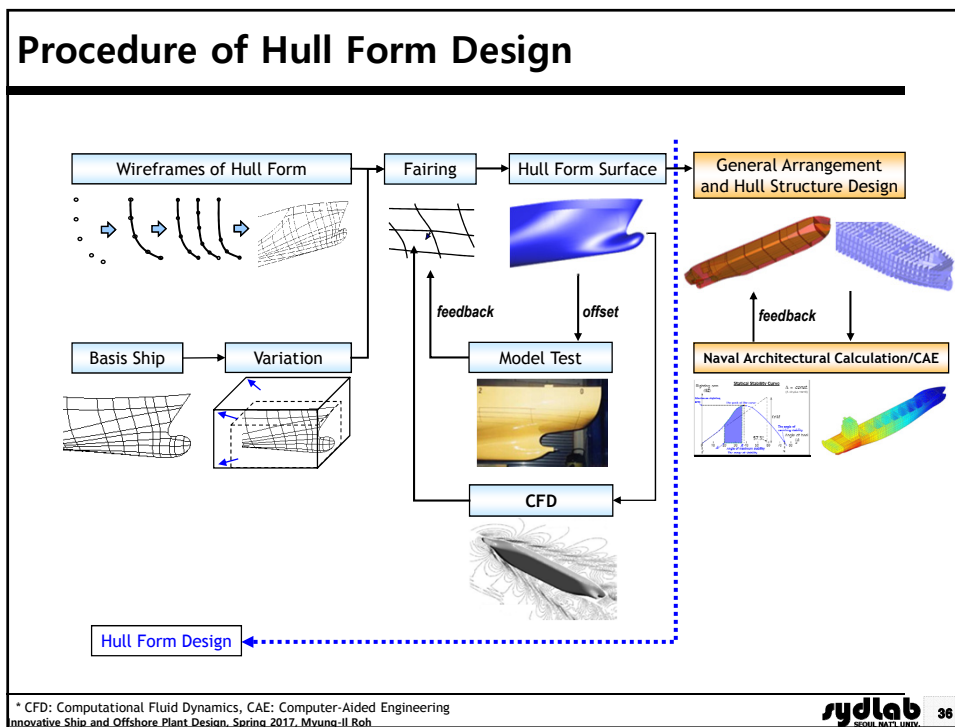
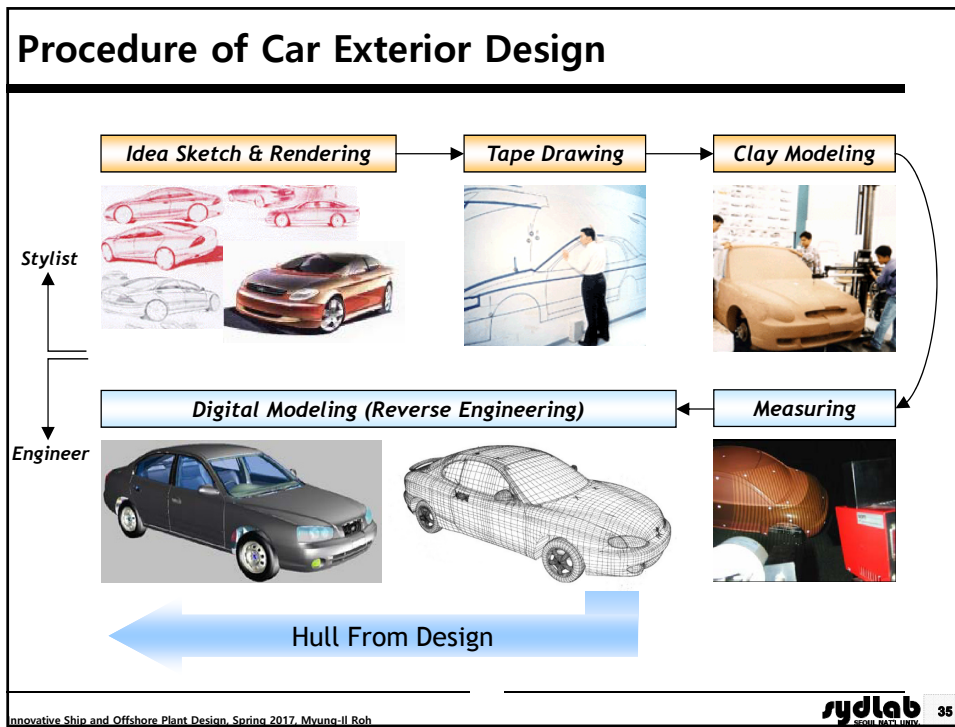

* CFD: Computational Fluid Dynamics, CAE: Computer-Aided Engineering
 Innovative Ship and Offshore Plant Design, Spring 2017, Myung-II Roh

4. Construction Procedure of a Ship

Construction Procedures of a Ship (Overview)

Deadweight 300,000 ton VLCC (Very Large Crude oil Carrier)

5 key events of construction procedures

* Deadweight 300,000 ton VLCC, L: 320.0 m, B: 58.0 m, D: 31.2 m,
3 soccer fields can be located on the deck.
* 63 building in Seoul, 249.0 m from the ground

* Reference: DSME

Key Event	Duration
Contract	-6 months
S/C or W/C*	Base date
K/L	+3 months
L/C	+6 months
D/L	+8 months
Total	14 months

* W/C: Work Commence. Starting date when S/C is made.

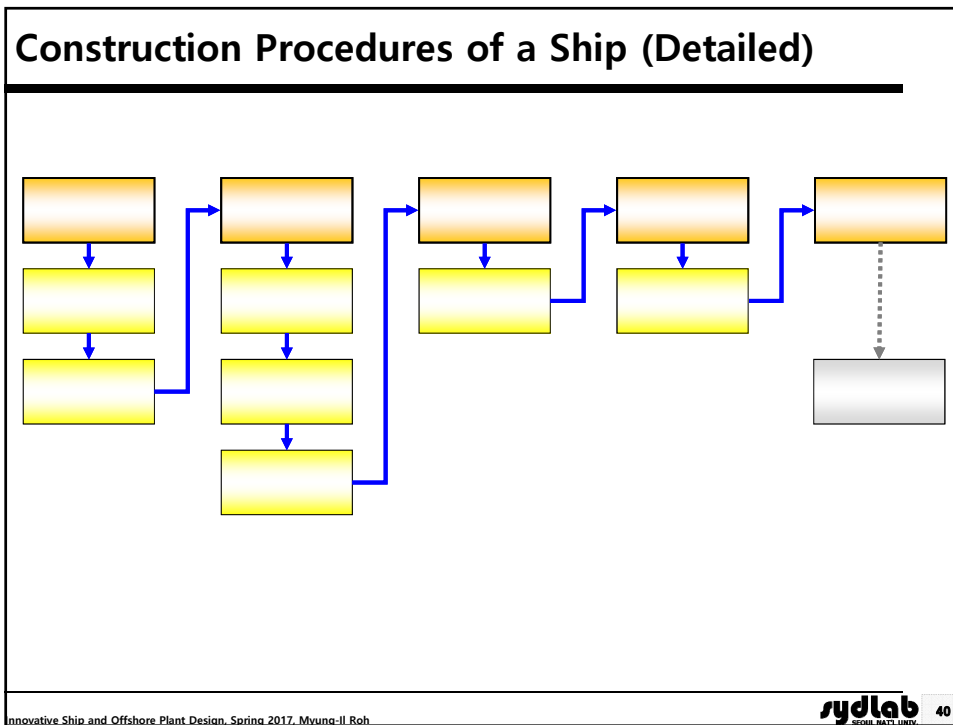
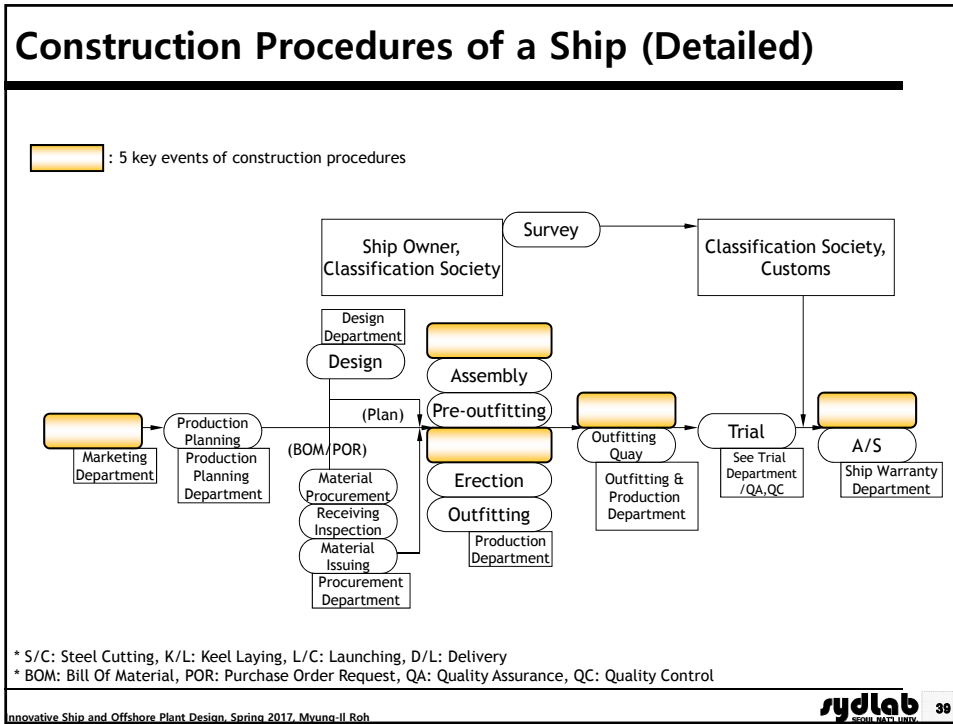

Design

Innovative Ship and Offshore Plant Design, Spring 2017, Myung-II Roh

41

Initial Design

- Hull Form Modeling of a 300,000 ton VLCC

계역	강재 횡단	용골 배치	전수	연도
배열	조립	상태	인벡 치합	
강재 위치 및 편차량	선형 의장 및 도장	선형 상태		

* 재와 중량 300,000톤 대형 유조선의 주요 치수
Lbp: 320.0m, B: 58.0m, D: 31.2m, Td: 20.8m, Ts: 20.8m, Cb: 0.8086

* 사정우, 강성진, 임종현, 이규열, 이상욱, 조두연, 노병철, "조선 전용 CAD 시스템: E2SHIP", 2003년도 한국CAD/CAM학회 학술발표회, pp.23-28, 서울, 2003.2.7

Initial Design - Compartment Modeling of a 300,000 ton

* 재화 중량 300,000톤 대형 유조선의 주요 치수
Lbp: 320.0m, B: 58.0m, D: 31.2m, Td: 20.8m, Ts: 20.8m, Cb: 0.8086

구획
선체 내부에 화물, 연료 등을 실을 수 있으며 선박 관련 규약(Rule)의 요구 사항을 만족하는 적재 공간

* Kyu-Yeul Lee, Sang-Uk Lee, Do-Yeoun Cho, Myung-II Roh, Seong-Chan Kang, Jung-Woo Seo, "An Innovative Compartment Modeling and Ship Calculation System", International Marine Design Conference(IMDC) 2003, pp.683-694, Athens, Greece, 2003.5.7

Initial Design (Hull Structure) - Hull Structural Modeling of a 300,000 ton

구조
구조적 안전성을 가지기 위한 선박 내부의 배대

화물창 내부의 모습

선체 중앙부를 확대한 모습

* 재화 중량 300,000톤 대형 유조선의 주요 치수
Lbp: 320.0m, B: 58.0m, D: 31.2m, Td: 20.8m, Ts: 20.8m, Cb: 0.8086

* Myung-II Roh, Kyu-Yeul Lee, "An Initial Hull Structural Modeling System for Computer-Aided Process Planning in Shipbuilding", Advances in Engineering Software, Vol. 37, No. 7, pp.457-476, 2006.7

Initial Design (Hull Structure) - Structural Analysis Modeling of a 300,000 DWT LCC

계획	간재 일단	용골 배치	전수	인도
상세 위치 및 좌표	조립	합체	안벽 직함	
상세 위치 및 좌표	상형 의장 및 도장	상형 의장 및 도장	상형 의장 및 도장	
상형 합체				

전선 구조 해석 모델
(global structural analysis model)

선체 구조 해석
선체가 구조적 안전성을 가지는지를 평가하는 작업

화물창 구조 해석 모델
(hold structural analysis model)

* Myung-II Roh, Kyu-Yeul Lee, Woo-Young Choi, Seong-Jin Yoo, "Improvement of Ship Design Practice Using a 3D CAD Model of a Hull Structure", Robotics and Computer-Integrated Manufacturing Journal(SCIE/IF:0.699), 2006.10.16[Article In Press, e-Journal Available]

Initial Design (Pipe Outfitting) - P&ID (Piping and Instrument Diagram)

계획	간재 일단	용골 배치	전수	인도
상세 위치 및 좌표	조립	합체	안벽 직함	
상세 위치 및 좌표	상형 의장 및 도장	상형 의장 및 도장	상형 의장 및 도장	
상형 합체				

P&ID: Piping & Instrumentation Diagram, Non-scaled drawing representing the relationship between equipment

Sea water cooling system

Outlet

Ejector

Sea chest

Topology data

CW022-500A: 응축기(condenser)로부터 나온 고온의 해수를 5°C 이하로 감압한 후 선측 외부로 배출하기 위한 직경 500mm의 배관 route

Ejector(안벽 조리기)

COPT VAC. CONDENSER FLOOR - FWD

COPT VAC. CONDENSER FLOOR - P

TO/FR VAC. COND.

* Sea water cooling system: 선체 내 각종 기기들을 냉각하기 위한 fresh water cooler 자체를 해수를 이용하여 냉각해 주는 배관 시스템

Detail/Production Design (Hull Structure)

- Result of Detailed/Production Design

계획	간략 설계	공용 배치	전수	완료
상세 목적 및 위치	조립	합체	인벡 작성	
상세 목적 및 위치	상세 목적 및 도장			
신형 설계				

Detailed design: 선박의 상세 성능을 결정하는 단계로서 System별 상세 도면을 작성

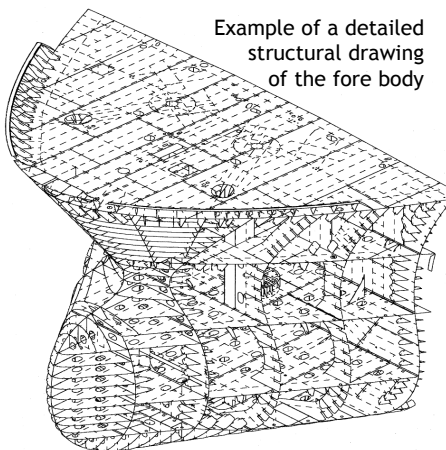

Example of a detailed structural drawing of the fore body

Production design: 선박의 생산을 위한 구획/블록별 건조 도면을 작성

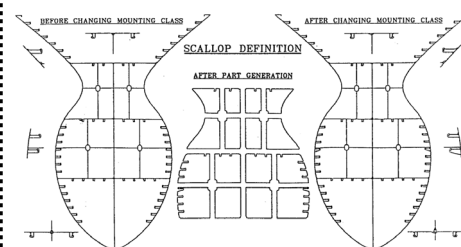

Example of a cutting drawing

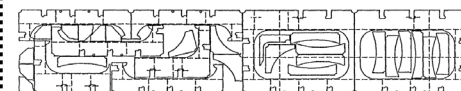

Example of a nesting drawing

Innovative Ship and Offshore Plant Design, Spring 2017, Myung-II Roh **sydlab** 47

Detailed Design (Pipe Outfitting)

- Pipe Modeling of a 300,000 ton VLCC

계획	간략 설계	공용 배치	전수	완료
상세 목적 및 위치	조립	합체	인벡 작성	
상세 목적 및 위치	상세 목적 및 도장			
신형 설계				

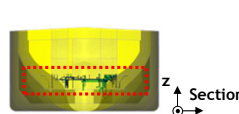

Section view

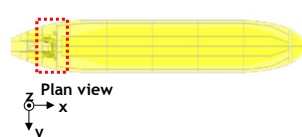

Plan view

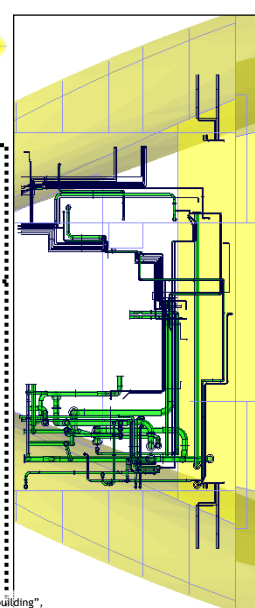

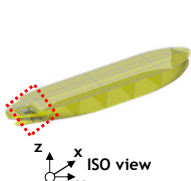

ISO view

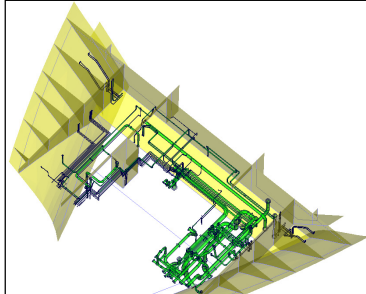

* Myung-II Roh, Kyu-Yeul Lee, Woo-Young Choi, "Rapid Generation of the Piping Model Having the Relationship with a Hull Structure in Shipbuilding", Advances in Engineering Software(SCIE/IF:0.371), 2006.12.1 [Article in Press, e-Journal Available Now]

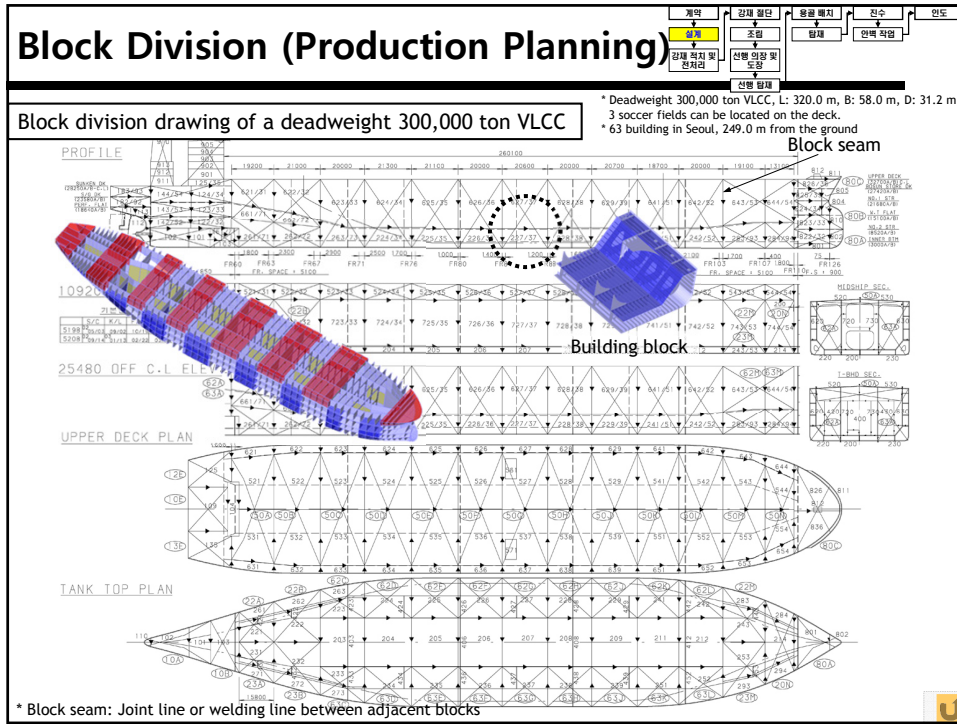

Piling Up and Preprocess of Steel Material

50

Innovative Ship and Offshore Plant Design, Sorina 2017, Mvuna-Il Roh

Piling Up and Preprocess of Steel Material - Piling Up of Steel Material

계역	강재 절단	공용 배치	전수	인도
상계	조립	합체	안벽 작업	
강재 위치 및 배치량	선형 의장 및 도장			
신형 강재				

- ☑ Steel material consists of plates and section steels which have the shape of bar.
- ☑ Piling up: 제철소에서 구매한 강재를 해상 또는 육상으로 운송하여 조선소의 야적장에 보관하는 공정
- ☑ Grouping: 각 호선(선박의 ID)별 사양 및 가공 일정에 따라 강재의 선별 작업을 실시 한 뒤 강재 전처리장으로 공급하는 공정
- ☑ Piling up method: "Using Pallet"





Pallet

Types of section steels



51

Piling Up and Preprocess of Steel Material - Preprocess of Steel Material

계역	강재 절단	공용 배치	전수	인도
상계	조립	합체	안벽 작업	
강재 위치 및 배치량	선형 의장 및 도장			
신형 강재				

- ☑ Shot blasting과 Shop priming 작업을 하여 강재 표면의 녹을 제거하여 도료의 부착을 좋게 하고 추후 녹 발생을 방지하는 공정
 - Shot blasting: 연소재(shot ball, cut wire)를 강판의 표면에 고속으로 투사하여 녹, 흑피(mill scale) 등을 제거하는 작업
 - Shop priming: 가공/조립 등의 공정 중 녹이 발생하지 않도록 shot blasting이 완료된 강판에 방청 도료(shop primer)를 도장하는 작업

Shot blasting



Shop priming



Types of shots



* 흑피(mill scale): 대기 속에서 금속을 가열하였을 때 표면에 생기는 금속산화물의 얇은 층. 검은색을 띰

52

Piling Up and Preprocess of Steel Material - Marking

계획 → 간접 생산 → 공급 배치 → 전수 → 인도
상세 → 조립 → 합체 → 인력 작업
상세 위치 및 판자량 → 신형 외장 및 도장 → 신형 합체

☑ **Marking:** 절단, 굽힘 및 조립 작업에 필요한 선과 기호를 기입하는 작업

최적화 기법을 이용한 Marking 토치 경로 생성 시스템의 예

Before: 84.67m

After: 39.26m

- ▶ NC(Numerical Control) marking 시 어떻게 하면 marking 토치의 이동 궤적을 최소로 할 수 있을까?
- ▶ 최적화 기법의 응용 예
 - * Nesting: 규격 강판을 가장 효율적으로 사용하기 위하여, 부재 조각들을 이리 저리 돌려 맞추어서 뒹고 잘려 나가는 강판의 잔재를 최소화 하는 작업
 - ▶ 어떻게 하면 자동으로 수율(규격 강판의 면적 대비 실제 사용할 수 있는 강판의 면적 비율)을 최대로 하는 nesting 결과를 얻을 수 있을까?
 - ▶ 최적화 기법의 또 다른 응용 예

조립을 위한 수작업 marking line의 예

최적화 기법을 이용한 Auto-Nesting 시스템의 예

Steel Cutting (S/C)

54

Innovative Ship and Offshore Plant Design, Sorina 2017, Mvuna-II Roh

계획	입력	공용 배치	전수	인도
실제	조립	합체	인력 직함	
강제 위치 및 편차량	선형 외장 및 도장			
신형 합체				

Steel Cutting (S/C)

- ☑ Cutting: Marking line을 따라
- ☑ Steel Cutting (S/C) or Work Commence (W/C): 강재를 처음으로 절단하는 것(착공식이라고 함)
- ☑ Cutting methods
 - Gas cutting, Plasma cutting, Laser cutting, Edge milling, etc.



Steel cutting using CNC flame cutting machine



Steel cutting using CNC plasma cutting machine



Steel cutting using edge milling machine (Hyundai Samho Heavy Industries)

- * Gas 절단: 강재를 가열하여 산화 반응이 일어나기 쉬운 온도 (약 800-900도)로 만든 후 고압 산소를 공급하면 발열 반응이 일어나 산화철이 생기고, 이를 고압 산소로 불어내어 절단
- * Plasma 절단: 기체 상태의 공기, 수소, 가스 등에서 전기적인 아크 방전을 일으키면, 그 기체가 부분적으로 plasma화 되는데, 이것을 열 물리적인 방법으로 수축시켜 최고 온도가 20,000-30,000도까지 이르게 하고 이를 부재에 닿게 하여 국부적으로 강재를 녹이고 고압 가스로 이를 불어내어 절단
- * Laser 절단: 빛을 증폭시켜 고밀도화 한 후 필요한 곳에 주사함으로써 국부적으로 강재를 녹이고 고압 가스로 이를 불어내어 절단
- * Edge milling: 공업용 다이아몬드를 이용하여 강재를 절단

* CNC: Computer Numerical Control **55**

계획	입력	공용 배치	전수	인도
실제	조립	합체	인력 직함	
강제 위치 및 편차량	선형 외장 및 도장			
신형 합체				

Plate Forming

- ☑ Plate forming:
 - Cold forming: 상온 상태에서 기계적인 힘을 가하여 재료에 소성 변형을 일으키는 것
 - 벤딩 롤러(bending roller) 또는 유압 Press를 이용한 단순한 1차 곡면(한 방향으로 곡률이 존재)의 성형
 - Step before hot forming
 - Hot forming: 강재를 국부적으로 가열하였다가 냉각시키면 그 부위가 수축하는 성질을 이용하여 굽힘 가공을 하는 것
 - Line heating
 - 부재에 고온의 열을 가해서 영구 변형을 얻는 2차 곡면(두 방향으로 곡률이 존재)의 성형 방법
 - 현재 세계 대부분의 조선소에서 2차 곡면의 성형 방법으로 사용하고 있으나 자동화의 어려움 때문에 전적으로 작업자의 수작업에 의존하고 있음



벤딩 롤러를 이용한 냉간 가공 모습



작업자에 의한 선상 가열 모습

Assembly

57

nnovative Ship and Offshore Plant Design, Sprina 2017, Myung-II Roh

Assembly

- Subassembly/Assembly

- Sub assembly
 - 블록을 구성하는
- Assembly
 - 소조립 블록들을 합쳐
 - 선박 건조 물량의 약 60% 이상이 처리되는 공정
 - 블록의 형상에 따라 크게 평블록 제작 공정과 곡블록 제작 공정으로 구분됨
 - Panel block
 - 전체 대조립 물량의 약 80%를 차지
 - 블록 및 내부재의 형상이 비교적 간단하여 자동화 시스템이 채용되어 있음
 - Matrix(Egg Box) 조립 공법, Line welder 조립 공법, Slit 조립 공법, Piece by piece 조립 공법
 - Curbed block
 - 전체 대조립 물량의 약 20%를 차지
 - 블록의 형상이 다양하고 복잡하여 자동화 시스템을 채용하기가 어려움
 - Line welder 조립 공법, Piece by piece 조립공법

계획	강재 절단	공용 배치	전수	연도
실제	조립	합체	인력 직입	
강재 위치 및 편차량	선형 의장 및 도장			
	선형 양재			

Example of sub assembly blocks

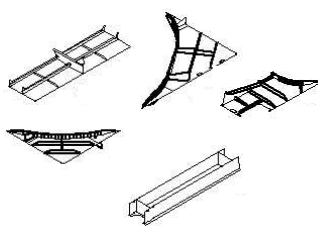

Example of assembly blocks

평블록(중앙부 이중저 블록)

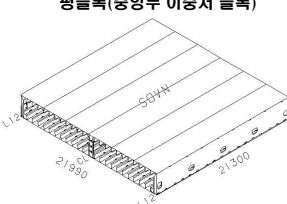

곡블록(선미부 블록)



Pre-Outfitting and Pre-Painting

Innovative Ship and Offshore Plant Design, Spring 2017, Myung-II Roh



계약	강제 용단	용물 배치	전수	안도
실계	조립	탐재	안벽 직입	
강제 적치 및 전처리	선형 의장 및 도장			
	선형 탐재			



Pre-Outfitting and Pre-Painting

☑ Pre-Outfitting

- 공기 후반에 오는 혼잡을 피하기 위해
- 블록 의장, 유닛(Unit) 의장, 탐재 동시 의장으로 구분

☑ Pre-Painting

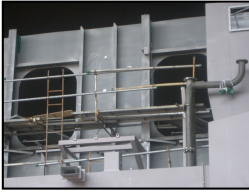
- 강제 전처리 과정에서의 강제 도장: "
- 조립 공정에서의 블록 도장: "
 - 선형 도장 전 블록 전처리 작업을 수행함
- 탐재 공정에서의 도장: "
 - 탐재 블록간 접합 부위에 대한 추가 전처리 및 도장 작업 수행

아중저 블록 내의 선형 의장

선형 도장 모습



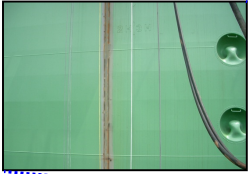

탐재 블록간 접합 부위

선박 측면

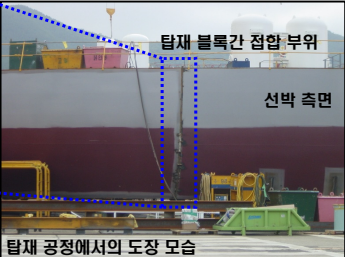

탐재 공정에서의 도장 모습

Block Preprocess

계약	간접 물단	공공 배치	전수	인도
설계	조립	합체	안벽 작업	
장비 설치 및 관리	신형 차량 및 도움			
	신형 장비			

☑ 블록 전처리 공정: 선형 도장 전에 조립 공정 중 발생한 부재 표면의 녹을 제거하여

- Blasting, Air blowing, Grit recovery 작업으로 구성됨
- Blasting: 작은 철 조각(grit)을 강판에 분사하여 녹을 제거하는 작업
- Air blowing: Air를 이용, 보강재(stiffener)의 상면 등에 쌓인 grit을 바닥으로 떨어뜨리는 작업
- Grit recovery: 바닥에 쌓인 grit, 분진 등을 회수하는 작업

① Block in

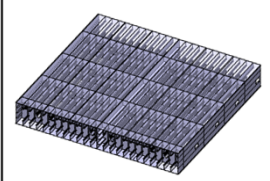

② Blasting

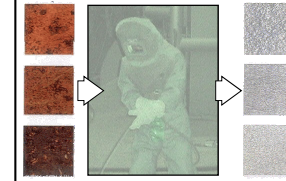

③ Air blowing

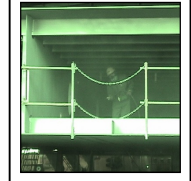

④ Grit recovery



⑤ Block out

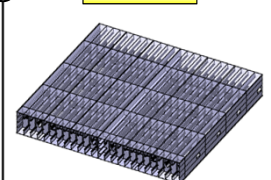

➔ Pre-Painting

VLCC 이중저 블록의 전처리 작업 공수
(작업 면적 약 4,000m², 표면 조도 SA2.5 기준)

- Blasting: 16명 X 3.5H = 56M/H
- Air blowing: 8명 X 1H = 8M/H
- Grit recovery: 8명 X 1.5H = 12M/H

Pre-Erection

62



Innovative Ship and Offshore Plant Design, Sorina 2017, Myung-Il Roh

Pre-Erection

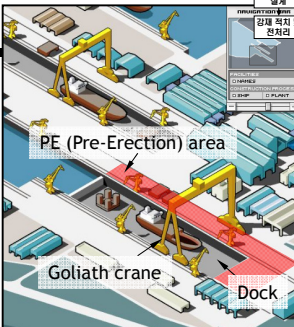
- ☑ Intermediate process between assembly and erection processes to increase erection efficiency
- ☑ This process makes by combining two or more hull blocks and outfitting near dock



PE (Pre-Erection) area
 Goliath crane
 Dock

Keel Laying (K/L)



64

Innovative Ship and Offshore Plant Design_Sorina 2017_Mvuna-Il Roh

Keel Laying (K/L)

계약	간접 물단	신용 평가	진수	인도
설계	조립	합체	안벽 직함	
장제 취지 및 한자면	신형 외장 및 도장			
신형 갑재				

The event when of block erection. . That means the starting point
 At this time, put several supports under the ship for supporting ship's weight



Support



Bottom shell

Erection

66

Innovative Ship and Offshore Plant Design_Sorina 2017_Myung-Il Roh

Block Erection Simulation Considering Semi-tandem Construction Method

Erection joint length

Semi-tandem Construction Method

→ 도크 내에서 완전한 안 척의 선박과
또 다른 선박의 선미부를 함께 건조하는 방법

* Myung-Il Roh, Kyu-Yeul Lee, "An Initial Hull Structural Modeling System for Computer-Aided Process Planning in Shipbuilding", Advances in Engineering Software, Vol. 37, No. 7, pp.657-676, 2006.7

History of the erection joint length by the semi-tandem construction method

Erection event (Number of erection blocks)	Erection joint length (m)
1	~50
11	~50
21	~50
31	~50
41 (Floating)	~50
51	~50
61	~50
71	~50
81	~50

Launching (L/C)

68

Innovative Ship and Offshore Plant Design, Sorina 2017, Myung-Il Roh

Launching (L/C)

계약	간재 용단	용골 배치	진수	안도
설계	조립	탑재	안벽 직입	
간재 적치 및 현차면	선형 의장 및 도장			
선형 탑재				

☑ 진수란 도크 내 또는 육상에서 건조한 선박을 각종 검사를 거친 후 처음으로 수상에 띄우는 것을 말하며, 진수 시기는 계약일 기준 약 12개월 정도임





* Reference: DSME

Launching

- Ground Launching Method of HHI and S

계약	간재 용단	용골 배치	진수	안도
설계	조립	탑재	안벽 직입	
간재 적치 및 현차면	선형 의장 및 도장			
선형 탑재				

☑ 도크가 아닌 육상에서 건조한 선박을 각종 검사를 거친 후 처음으로 수상에 띄우는 것을 말하며, 진수 시기는 계약일 기준 약 12개월 정도임

☑ Overall procedures of ground launching method

1. 육상에서 선박 탑재 완료
2. 육상 건조장 옆에 두 대의 바지선을 연결하여 배치
3. 독일의 잠수함 원리와 스위스가 개발한 이동시스템 원리("레일")를 이용하여 선박을 바지선 위로 끌어냄("Road Out 기술")
4. 선박을 실은 바지선을 깊은 바다로 이동시킴
5. 바지선을 수면 아래로 가라 앉힘
6. 선박의 진수 완료



으로 2004년 10월 현대중공업이 세계 최초로 성공



* Reference: Hyundai Heavy Industries
Innovative Ship and Offshore Plant Design, Sorina 2017, Mvuna-Il Reh



Quay Work

Innovative Ship and Offshore Plant Design, Spring 2017, Myung-II Roh



Quay Work - Outfitting/Painting



- ☑ After launching the ship, put her on the quay and



Quay Work - Sea Trial

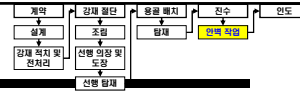

for conducting to measure her performance and general seaworthiness.

- ☑ It is usually the last phase of construction and takes place on open water, and it can last from a few hours to many days.
- ☑ The ship's speed, maneuverability, equipment, and safety features are usually conducted.
- ☑ Typical trials: speed trial, crash stop, endurance, maneuvering trials, seakeeping



Delivery (D/L)

Delivery (D/L) - Naming Ceremony and Delivery

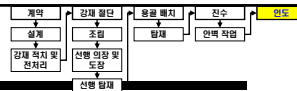

Naming Ceremony of FPSO (Floating Production Storage Off-loading)

ship owner to a

